



Quality by Witzemann



**Witzemann GmbH**

Östliche Karl-Friedrich-Str. 134  
75175 Pforzheim  
Phone +49 7231 581-0  
Fax +49 7231 581-820  
wi@witzemann.com  
www.witzemann.com

1501uk/19/10/23/pdf

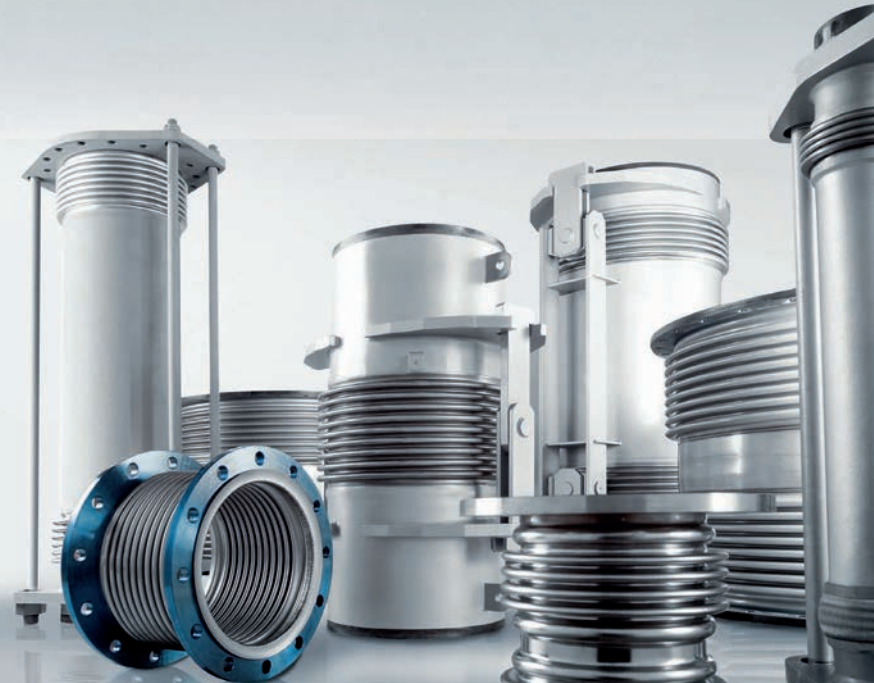
**WITZENMANN**

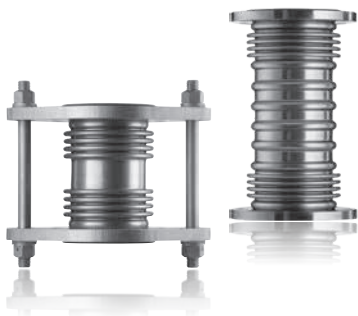
managing flexibility

EXPANSION JOINTS

# EXPANSION JOINT MANUAL

**WITZENMANN**





Updated edition of the Manual of Expansion Joint Technology according to the new company standard and Pressure Equipment Directive.

Updated: 10/2023

Subject to technical alterations.

**You can also find technical information as a PDF download at [www.flexperte.de](http://www.flexperte.de)**

# CONTENTS

<b>Chapter 1</b>	<b>Witzenmann – the specialist for flexible metal elements</b>	<b>6</b>
<b>Chapter 2</b>	<b>Quality Management</b>	<b>8</b>
<b>Chapter 3</b>	<b>The Expansion Joint</b>	<b>18</b>
<b>Chapter 4</b>	<b>Compensation Types</b>	<b>34</b>
<b>Chapter 5</b>	<b>Selection of Expansion Joints</b>	<b>48</b>
<b>Chapter 6</b>	<b>Standard Ranges</b>	<b>78</b>
Type ABN, AFN	Axial expansion joints for low pressure (exhaust) with flanges	84
Type ABN, AFN	Axial expansion joints with flanges	102
Type UBN, UFN	Universal expansion joints for low pressure (exhaust) with flanges	154
Type UBN, UFN	Universal expansion joints with flanges	160
Type ARN	Axial expansion joints for low pressure (exhaust) with weld ends	166
Type ARN	Axial expansion joints with weld ends	176
Type URN	Universal expansion joints for low pressure (exhaust) with weld ends	206
Type URN	Universal expansion joints with weld ends	210
Type WBN, WBK	Angular expansion joints with loose flanges	214
Type WFN, WFK	Angular expansion joints with plain fixed flanges	228
Type WRN, WRK	Angular expansion joints with weld ends	242
Type LBR, LFR	Lateral expansion joints with flanges	278
Type LRR, LRK, LRN	Lateral expansion joints with weld ends	324
Type LBS	Lateral expansion joints with loose flanges, sound insulating	376

<b>Chapter 7</b>	<b>Special Ranges</b>	<b>386</b>
Type AON	Single ply expansion joints for apparatus construction	396
Type ABT	Axial expansion joints with PTFE lining	406
Type ARH	Axial expansion joints with automatic release mechanism	416
Type DRD	Pressure balanced axial expansion joints	430
Type XOZ, XZF, XRZ, XSZ	Rectangular expansion joints	434
<b>Chapter 8</b>	<b>Custom-built Designs</b>	<b>442</b>
<b>Chapter 9</b>	<b>Installation of Expansion Joints</b>	<b>460</b>
<b>Chapter 10</b>	<b>The Multi-ply Principle</b>	<b>484</b>
<b>Chapter 11</b>	<b>Design of the Bellows</b>	<b>492</b>
<b>Chapter 12</b>	<b>Axial Pressure Thrust and Pressure-balanced Designs</b>	<b>498</b>
<b>Chapter 13</b>	<b>Vibrations and Sound</b>	<b>508</b>
<b>Chapter 14</b>	<b>Manufacturing and Testing</b>	<b>524</b>
<b>Chapter 15</b>	<b>Marking, Corrosion Protection, Packaging</b>	<b>530</b>
<b>Chapter 16</b>	<b>Installation Instructions</b>	<b>534</b>
<b>Chapter 17</b>	<b>Materials</b>	<b>538</b>
<b>Chapter 18</b>	<b>Corrosion Resistance</b>	<b>564</b>
<b>Chapter 19</b>	<b>Pipes, Flanges, Pipe Bends</b>	<b>602</b>
<b>Chapter 20</b>	<b>Conversion Tables and Formula Symbols</b>	<b>620</b>

# WITZENMANN – THE SPECIALIST FOR FLEXIBLE METAL ELEMENTS



# PROBLEM-SOLVING EXPERTISE

Whenever pipes expand due to frequent changes of temperature or pressure, when vibrations occur in pipework, whenever heavy loads have to be carried, when pressure-tight transport of media is essential, when high vacuum must be maintained – these are all situations where flexible metal elements are called for. These elements include expansion joints and metal bellows as well as metal hoses, automotive components and pipe supports. Witzenmann, the inventor of the metal hose and founder of the metal hose and expansion joint industry is your first port of call here. The basic invention, a metal hose that was developed and patented in 1885, was followed by a patent for the metal expansion joint in 1920.

## Worldwide presence

As an international group of companies with a total of more than 4,300 employees in 24 companies, Witzenmann stands today for innovation and high quality. With the broadest product range in the industry, Witzenmann offers problem solutions for decoupling vibrations, accommodating expansion in pipes, flexible installation and conveying media. Witzenmann is a development partner for industrial customers in the technical building equipment industry, automotive industry and numerous other markets, with in-house machine design, toolmaking and prototyping as well as extensive inspection and testing equipment. Crucial to the cooperation with customers are the consultancy services provided by the competence centre at the Witzenmann headquarters in Pforzheim, southern Germany. Teams of highly qualified engineers work in close collaboration with the customer on product developments and new expansion joint applications. From the preliminary design to series production.

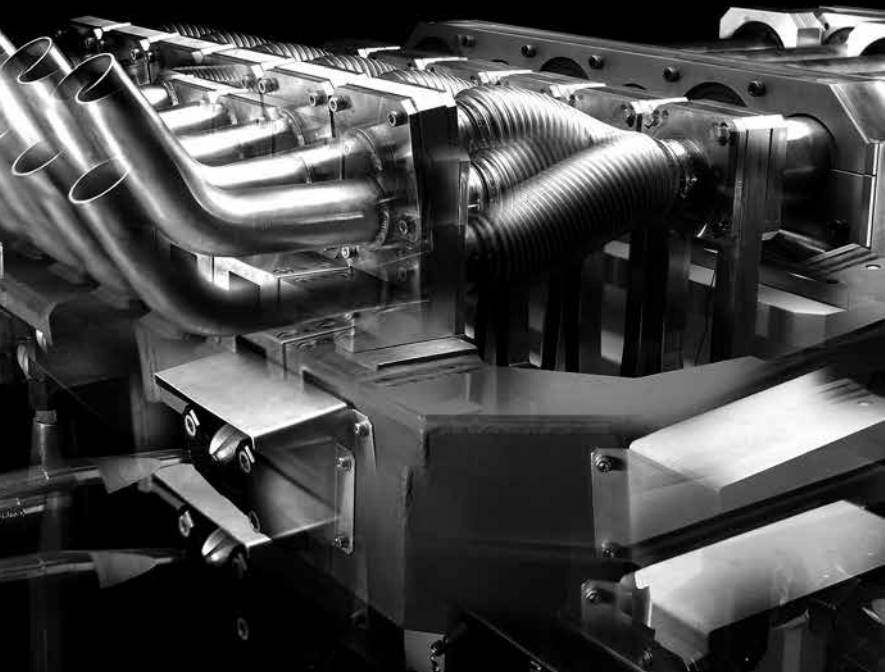
## Better products

This concentration of knowledge is the basis for the synergy that is evident in every product solution. Our products have an almost unlimited and diverse range of applications. However, they all have one thing in common – maximum safety even in the most extreme operating conditions. This applies to all Witzenmann solutions.

# QUALITY MANAGEMENT

02

Before a newly developed flexible element goes into production, it passes through an extremely hard testing program in our modern development centre: electrodynamic vibration test rigs, hot gas and service life testing systems, corrosion testing and portable testing facilities.



These tests Witzenmann not only ensure that the products have an optimum configuration but also enable them to withstand all conceivable loads over a long period of time. Witzenmann has been working consistently to these high standards for a long time. In 1994, Witzenmann was the first company in this sector to gain accreditation to DIN ISO 9001. Here too, continuous development is occurring. Witzenmann currently has an approval according to the much stricter standard IATF 16949. These certifications are the basis for our leading position in the market.

## GENERAL APPROVAL TESTS



*Quality management system according to DIN ISO 9001*

*South West Technical Inspection Association (TÜV) inspection and confirmation as a manufacturer according to AD data sheet HP0, W0 and according to TRD 100*

## SPECIFIC APPROVALS (selection)



*DVGW - German Technical and Scientific Association for Gas and Water*



*ÖVGW - Austrian Association for Gas and Water*



*ABS - American Bureau of Shipping, USA*



*BV - Bureau Veritas, France*



*DNV GL, Norway/Germany*



*LRS - Lloyd's Register of Shipping, United Kingdom*



*RINA - Registro Italiano Navale, Italien*



*BAM - Federal Agency for Material Research and Testing*



*VDE - Testing and Certification Institute*



*VdS - Association of Insurers*



*FM Global, USA*



*ASME - The American Society of Mechanical Engineers, USA*



*NBBI - The National Board of Boiler and Pressure Vessel Inspectors, USA*



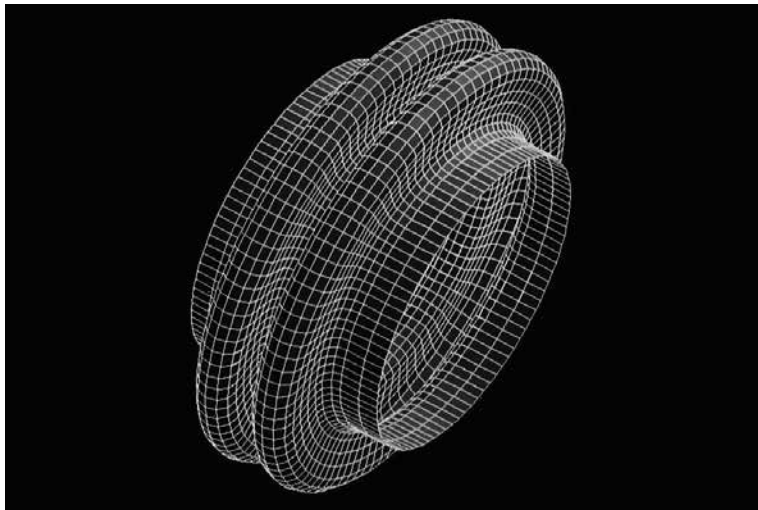
## TIGHTLY ORGANIZED RESPONSIBILITY FOR QUALITY

02

Our quality assurance is organized on two levels. The central quality management is charged with the task of overall organizational and technological quality assurance measures. The quality departments of our business divisions manage quality planning, quality assurance and quality control in the course of handling the processing of orders. The quality assurance is independent of production in terms of organization. It is authorized to issue directives to all employees engaged in activities that influence quality.

### Calculation and design

Our central departments provide the basis for calculating and designing our products. Our work is based on comprehensive theoretical investigations and tests. The individual business divisions finally implement the design work requirements, taking product-specific features and design requirements into account.



*Fig. 2.1 FEM Structure of a metal bellows*

### **Meticulous control of suppliers**

We only work with suppliers who can provide proof of effective quality assurance. We demand test certificates for semi-finished products strip, sheet, pipes and wires, which comply with the intended purpose of the parts. We ensure that the supplied products meet our order and acceptance specifications by means of receiving inspections in our incoming goods department and material laboratory.

### **Continuous production monitoring**

Our operational supervision is responsible for inspection and maintenance of manufacturing equipment and properly implemented production procedures in the production process according to provisions of the production documents provided.

### **Complete monitoring of welding processes**

Welding processes are regulated based on written instructions. The qualification of the welders is ensured by means of examinations in accordance with EN ISO 9606-1/EN ISO 9606-4. The most important and frequently applied welding techniques are certified by means of process audits. The welding supervision meets the respective requirements according to AD Sheet HP3.

### **Supervision of measuring and testing equipment**

All measuring and testing equipment is registered and documented. It is inspected for accuracy and reliability at regular intervals. The date of calibration is recorded by control marks.

## **QUALITY PUT TO THE TEST**

### **Product audit**

Extensive systematic audits carried out in the last few years have allowed us to take the step from empirical knowledge based on routine to the development of system knowledge. On one hand, this systematic knowledge is the precondition for product development and optimisation. On the other hand, it is necessary to meet the increasing demand of the market for information about all product properties. Especially in safety-relevant applications for the aerospace and automotive industry.

## Materials testing

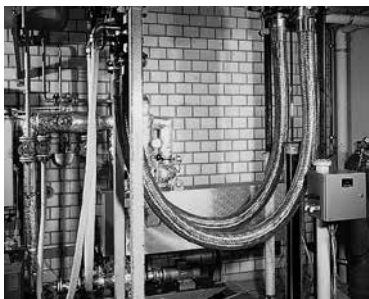
The demand for economic production is determined by a selection of suitable materials. Extensive knowledge of material properties is the precondition both for this selection processes and the demand for an increase in quality and safety.

Semi-finished parts for our products are high grade, mostly thin strips, wires, sheets or thin-walled pipes. The high quality requirements for our semi-finished parts are documented in our order and acceptance specifications. Apart from the stipulations of national and international standards and provisions, the quality requirements also include specific internal requirements concerning production and documentation. Incoming inspections ensure that the parts are inspected in compliance with geometrical, mechanical, technological and chemical properties required in our specifications.

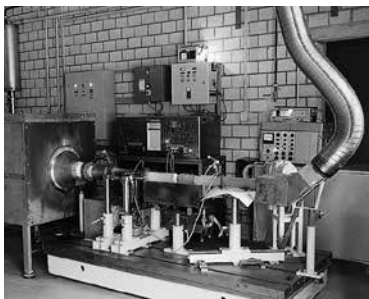
The tasks of the material inspection department also include the execution of mechanical, technological and metallographical audits as well as process and acceptance audits of welding operations.

For non-destructive testing of elements and welding seams, X-ray as well as a visual inspection and penetration testing are used. Furthermore a leak test on the welded expansion joints takes place.

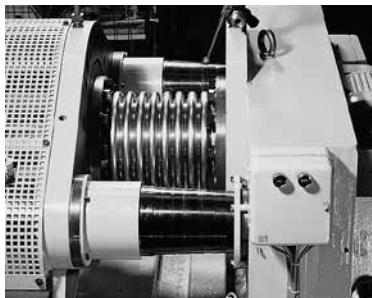
Our material laboratory is recognised as a production-independent testing authority for destructive and non-destructive material testing with the approval to issue certificates of acceptance.



*Fig. 2.2 Test bench for load cycle tests for hose assemblies of high nominal diameters in U-bend installation under internal pressure and fluid temperatures of up to 300 °C*



*Fig. 2.3 Test bench for load cycle tests for flexible parts in exhaust systems with exhaust gas temperatures of up to 1100 °C*



*Fig. 2.4 Test bench for load cycle tests with an expansion joint DN 200*



*Fig. 2.5 Vibration test bench for simulation of complex application conditions*

## **Damage analysis**

Another task of the material inspection is the damage analysis of products that have failed during testing or operation. Metallographical inspections are usually carried out and the damage symptoms are documented by means of photographic images.

## **Quality of the expansion joints**

In the interest of our customers, we place high demands on our expansion joints with regard to performance, quality and reliability.

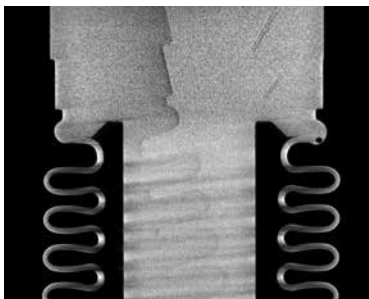
For this reason, the quality-assurance process also inspects the incoming materials used for manufacturing, continuously monitors production and subjects the finished products to meaningful final inspections before leaving our plant.

In addition to that, destructive product and functional tests are performed with the expansion joints from current production.

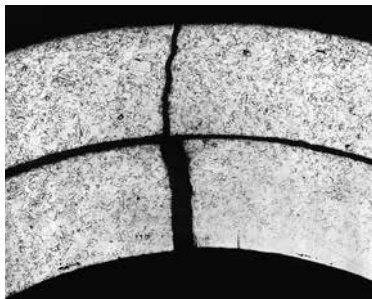
The use of high-quality materials, optimised material-friendly manufacturing procedures, modern mechanical facilities and equipment – and not least of all – responsible, qualified personnel are the most important guarantees of quality for our products.



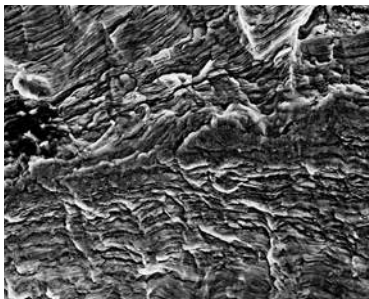
*Fig. 2.6 Alternating bending machines for determining the fatigue behaviour of thin strips and sheets*



*Fig. 2.7 Non-destructive testing by means of radiographic examination.*



*Fig. 2.8 Micrograph of a cross section on a fatigue fracture in a thin bellows ply*



*Fig. 2.9 Fatigue fracture under the scanning electron microscope*

As part of the quality assurance, we have defined the minimum requirements stipulated for materials in ordering and acceptance specifications for the most important types.

Test certificates for the materials used can be requested subject to a charge. Strip material that is normally in stock can be confirmed with inspection certificate 3.1 or 3.2 according to DIN EN 10204. Possible certificates of the conducted tests are listed in DIN EN 10204 (see Table).

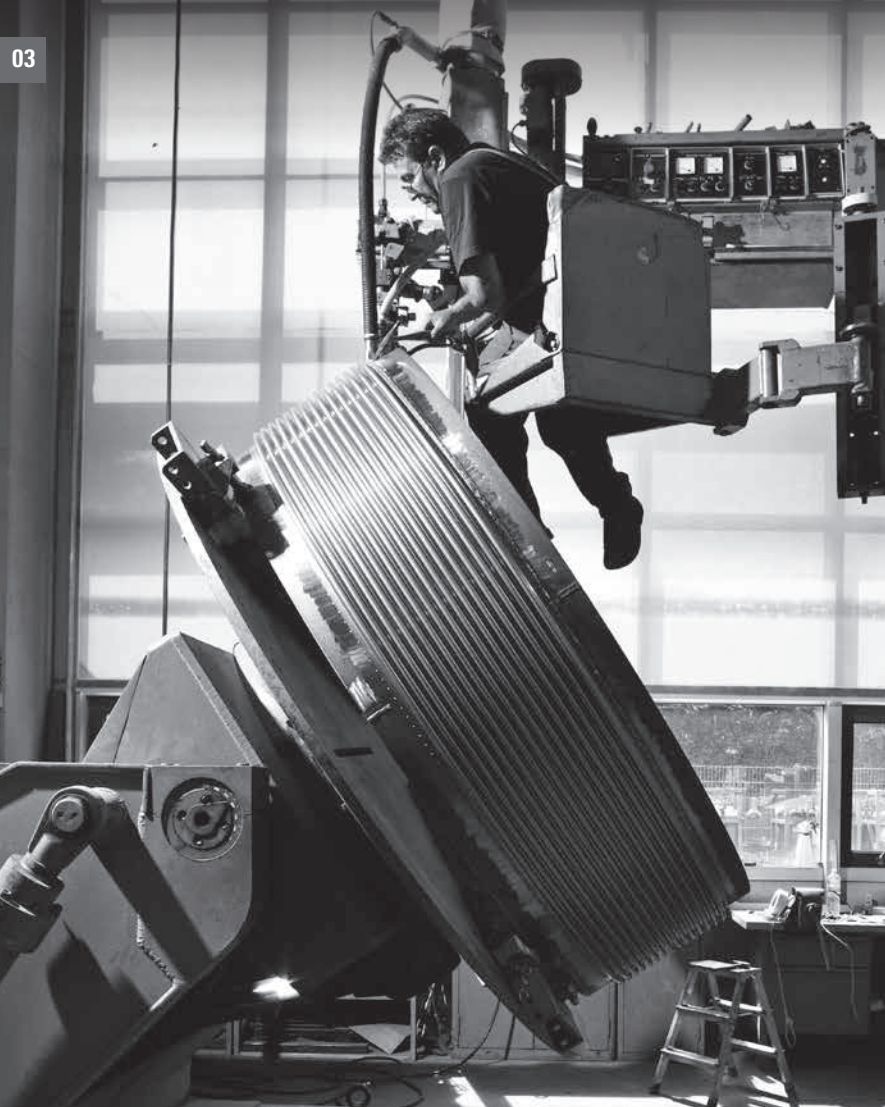
We would like to point out here that the scope of the required material tests can have a significant impact on product and testing costs as well as on delivery times. For this reason, disproportionately stringent requirements should be avoided.

Name	Test certificate	Type	Contents of certificate	Conditions	Confirmation of certificate
2.1	Declaration of compliance with the order	non-specific	Confirmation of conformity with the order.	According to the delivery conditions of the order or, if requested, according to the official provisions and applicable technical regulations.	By the manufacturer.
2.2	Test report		Confirmation of conformity with the order stating results of nonspecific test.		
3.1	Inspection certificate 3.1	specific	Confirmation of conformity with the order stating results of specific test.		By the manufacturer's authorized inspection representative who is independent of the production department.
3.2	Inspection certificate 3.2			According to official regulations and applicable technical rules.	By the manufacturer's authorized inspection representative who is independent of the production department as well as by the authorized inspection representative authorised by the orderer or the authorized inspection representative stated in the official regulations.



# THE EXPANSION JOINT

03



The various types of expansion joints (for examples see Figs. 3.1 and 3.2) serve to compensate movements in pipes, on machines and apparatus. The movements, which are always relative between two plant components, are caused by thermal expansion, pressure deformation, forces of gravity, misalignment or foundation settlements.



Fig. 3.1 Axial expansion joint

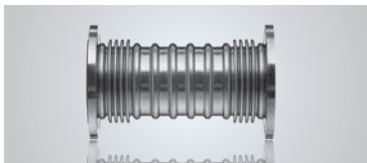


Fig. 3.2 Universal expansion joint

## CONNECTIONS

Expansion joints are connected either by welding to the pipes or vessel walls or by flanging, e.g. to machine connecting pieces. The standard types of connection part are weld ends and flanges; in special cases screwed nipples are used. (Figs. 3.3 – 3.5).



Fig. 3.3 Weld end

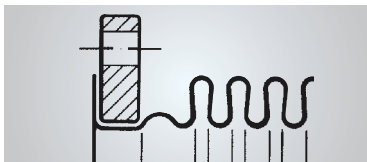


Fig. 3.4 Loose flange



Fig. 3.5 Threaded nipple

# THE BELLOWS AND ITS PRINCIPLE OF OPERATION

The basic flexible element of an expansion joint is the metal bellows, which is flexible on all planes due to its annular corrugations. This flexibility is utilized in the expansion joint in different ways according to the construction type (Fig. 3.6). The flexibility of the bellows is derived from the flexibility of the radial corrugation flanks (Fig. 3.7)

03



Fig. 3.6 Movements of the bellows

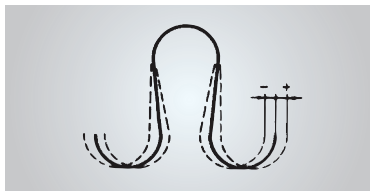


Fig. 3.7 Principle of operation of a bellows corrugation

In addition to flexibility, the metal bellows must have a certain pressure resistance. Flexibility and pressure resistance are contrary requirements, which in extreme cases result in different corrugation shapes. The lyre-shaped corrugation is a good compromise which combines considerable flexibility and an adequate pressure resistance (Figs. 3.8 – 3.10).

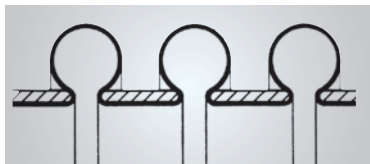


Fig. 3.8 Toroidal shape, extremely pressure resistant



Fig. 3.9 Diaphragms, extremely flexible

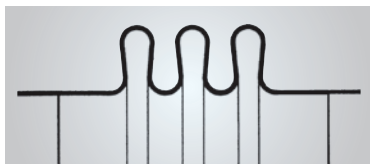
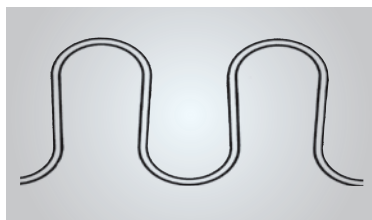


Fig. 3.10 Lyre-shape, pressure resistant and flexible

The lyre-shaped corrugation, to which the description below is targeted, can be adapted to specific requirements by altering its geometry. It is also possible to increase the number of plies; which leads to the multi-ply bellows as a technically favorable solution. (See also Chapter 10, "The Multi-ply Principle"). Figs 3.11 – 3.13 show an optical comparison of the various possible types of bellows.

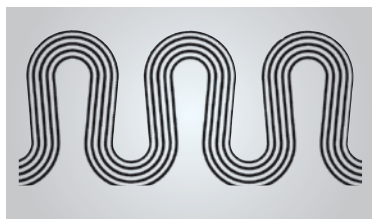
Although the multi-ply bellows is relatively complicated with regard to its design and manufacturing process, it is used as the basic elastic element in our expansion joints thanks to its favourable characteristics. There, it has proven to be successful over many years, especially in designs subject to pressure loads.



*Fig. 3.11. Single-ply bellows*



*Fig. 3.12. Double-ply bellows*



*Fig. 3.13 Multi-ply bellows*

## RESTRAINT HARDWARE

The various types of restrained expansion joints are fitted with different types of restraint hardware corresponding to the respective functions which must absorb the axial pressure thrust and permits angular or lateral flexibility. The most important types of restraint hardware are shown in Figs. 3.14 – 3.17. The details of the hardware designs may differ. They are shown in the diagrams for the individual type series.

03



Fig. 3.14 Angular expansion joint "WRN"

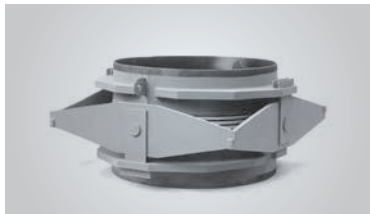


Fig. 3.15 Gimbal expansion joint "WRK"

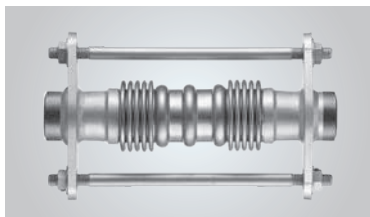


Fig. 3.16 Lateral expansion joint with tie rods and spherical washers "LRR"

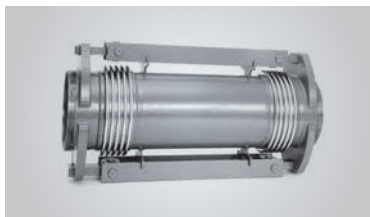


Fig. 3.17 Lateral expansion joint with gimbal joints "LRK"

# ASSEMBLY PARTS

There are a number of additional assembly parts which may be required from case to case. The most common are described below:

- **Inner sleeve**

Internal pipe, usually made of stainless steel. It protects the bellows from direct contact with the flowing medium and reduces the flow resistance.

- **Guide sleeve**

Pipe either inside or outside the bellows. It guides it at defined points or over the entire length to prevent buckling.

- **Protection cover**

Pipe on the outside of the expansion joint. It protects the bellows from mechanical damage and from dirt accumulation in the corrugations, and acts as a carrier for thermal insulation.

- **Reinforcing rings**

Rings in the root of the bellows corrugations to increase the pressure resistance of the bellows

## TECHNICAL CHARACTERISTICS

HYDRA expansion joints are in line with the latest state of the art (concerning technology and manufacturing processes) and are fully-developed, flexible metal elements for universal use in modern pipe and plant construction.

Their outstanding characteristics are based on an ideal combination of design details resulting from intensive development work and several decades of practical experience.

### The multi-ply bellows

The multi-ply bellows described above provides HYDRA expansion joints of all types with a series of technical and economic advantages, which are described in detail in Chapter 10, "The Multi-ply Principle"; they are only listed in brief here:

- Suitable for very high pressures
- Large movement absorption
- Compact size
- Low adjustment forces
- Optimum compensation in small spaces
- Early indication of leakage (in the event of damage) through check hole
- Total bursting safety
- Possibility of permanent leak monitoring for critical media
- Economic use of high-quality, corrosion-resistant materials, such as nickel-base alloys, iron-nickel-chromium alloys, titanium and tantalum
- Insulation against structure-borne noise up to 20 dB

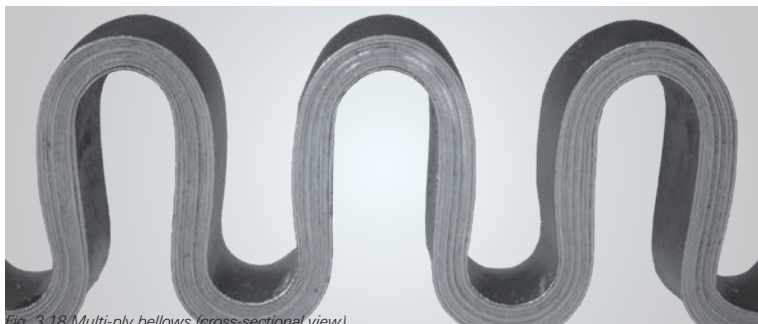


Fig. 3.18/Multi-ply bellows (cross-sectional view)

## The weld connection

The connection between a multi-ply bellows made of austenitic stainless steel and a ferritic weld end (or flange) requires special welding procedures. Still more stringent demands are made on the design of the weld area and on the welding process when special alloys must be welded. Even though the weld seam is mechanically loaded only with a part of the axial pressure thrust, due to over pressure in the annular chamber of the corrugations and by the slight adjusting forces of the bellows on tension and compression, it must nevertheless remain absolutely tight throughout the entire operating period and thus is crucial to the quality of the expansion joint.

For this reason, special measures must be taken to ensure a low stress level. The bending moment produced by the movement of the bellows in the corrugation flanks is reduced before it reaches the weld connection:

- A raised bellows tangent generates a relieving counter torque
- Press-fitted rings reinforce the bellows cuff and thus reduce the stress level
- Cylindrical tangents reduce any possible residual bending stresses

The standard seam shown in Fig. 3.19 can verifiably be examined non-destructively. However due to the low stress level, the costly examinations necessary to assure the quality of other types of seam can be eliminated. It is sufficient to perform a standard leak test.

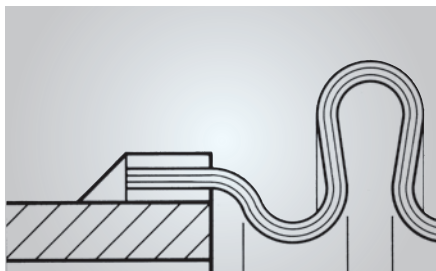


Fig. 3.19 Connection seam of bellows/weld end



### The loose flange

Like fixed flanges, loose flanges offer the familiar advantages of flange connections, such as rapid assembly and exchangeability of components.

03

Since loose flanges are also not welded to the bellows, but form-fitted and assembled on it so that they are rotatable (Fig. 3.20), they have a number of additional advantages:

- The rotatability simplifies assembly allowing alignment of the flange holes
- The flanges are not in contact with the media, which may be aggressive, and can be made either of normal steel or special materials, such as aluminium and plastic
- The flanges can be protected against corrosion at relatively little costs by means of suitable coating or galvanization
- For single bellows plies special materials can be used which can't be welded to the other bellows plies or to the flange

Expansion joints with smaller nominal diameters can be fitted with loose flanges and lap joint stub ends, which largely offer the same advantages. The spacer bead shown in Fig. 3.20 simply keeps space clear for the screw assembly and prevents the risk of damage to the corrugations during assembly. Furthermore, the design enables the unhindered movement of the corrugations at either end.

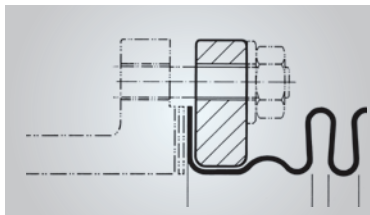


Fig. 3.20 Form-fitted connection between bellows and loose flange

## The inner sleeve

Internal sleeves are used whenever expansion joints must be protected from:

- abrasion caused by solid particles in the flowing medium
- deposits of solid components in the corrugations
- vibrations generated by high flow velocities

Internal sleeves theoretically also reduce the pressure losses in the flow through the expansion joint. In practice however, these pressure losses are so low – roughly twice as much as those in a pipe of identical length – that the effort is rarely worthwhile.

Our expansion joints with loose flanges are provided with form-fitted pressed-in inner sleeves (Fig. 3.21) which can also withstand vibration loads.

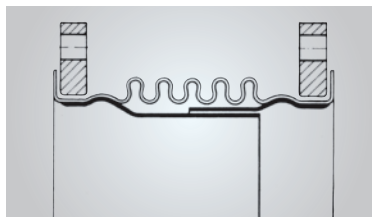


Fig. 3.21 Form-fitted inner sleeves

### The patented restraint hardware

03 Hammer-shaped tie-bars inserted in plates (Fig. 3.22) combined with multi-ply bellows permit extremely short total lengths of our HYDRA restrained expansion joints. The full benefit of this is particularly apparent in hinge systems with angular expansion joints, since it also results in small overall dimensions for the hinge system and possibly required structures.

The hammer-shaped tie-bars are form-fitted to the plates and the plates are welded around the pipe so that the forces and stresses are evenly distributed. The effects of unintentionally overloading the restraint hardware, e.g. as a result of impulse pressure, are thus less drastic. The plate yields and deforms. Together with the effective safety against bursting of the multi-ply bellows, this acts as an efficient safety reserve.



Fig. 3.22 Hammer-shaped tie rod

# CHOICE OF MATERIALS

The wide variety of applications for which our bellows are used necessitates an appropriate choice of materials.

In the tables in Chapter 17 we have listed the common materials we use and frequently used special materials with all necessary data in order to simplify the selection of suitable materials in each case.

The most important demands made on the material are:

- Corrosion resistance
- Temperature resistance
- Strength
- Welding properties
- Forming properties

## Materials for general applications

Standard materials from the group of austenitic stainless steels are 1.4301, 1.4541, 1.4571 and 1.4404. These materials are particularly suitable to satisfy the requirements over a wide range of applications. With regard to quick availability and optimised storage, Witzemann manufactures bellows from 1.4541 for general applications.

## Material 1.4541 – standard for bellows production

1.4541 is used in the chemical industry, food industry, in exhaust systems, in district heating and compressor pipe systems and in cryogenics. Since titanium is added in 1.4541, unlike 1.4301, this material has better resistance to intercrystalline corrosion up to 400 °C.

## Material 1.4571

Like the 1.4541, 1.4571 is used in the chemical industry, food industry, in exhaust systems, in district heating and compressor pipe systems as well as in cryogenics. 1.4571 has proven itself, above all, for decoupling elements in exhaust systems of motor vehicles and for use in drinking water piping. As with 1.4541, 1.4571 is stabilised with titanium, which increases its resistance to intercrystalline corrosion. In addition, molybdenum is added in 1.4571, so that it is more resistant to pitting corrosion than 1.4541, which can occur if chlorides are present.

### Material 1.4301

For strip-wound hoses, which are used in, for example, exhaust systems of trucks, the high-alloy steel 1.4301 exhibits adequate corrosion resistance. The corrosion resistance is attributable to the elements chromium and nickel.

03

### Material 1.4404

1.4404 is used for components in vacuum technology. It has also proven itself as hose material. The chemical composition largely matches that of 1.4571. In comparison to 1.4571, 1.4404 is not stabilised with titanium. Through a reduced carbon content of less than 0.03 %, however, it has a similar resistance to inter-crystalline corrosion. Due to the reduced carbon content, the strength properties are slightly lower than those of 1.4571.

## MATERIALS FOR CORROSIVE MEDIA

Highly corrosive conditions require the use of special materials that should at least have the corrosion resistance of the connected pipe or fittings.

If in doubt, a higher-grade material should be chosen. In many cases, nickel-based alloys are suitable for this, a fact that is substantiated by good experiences. For expansion joint bellows the materials 2.4856 (Alloy 625) or 2.4610 (Alloy C-4) are preferred, for bellows of smaller size (diameter < 100 mm) the material 2.4819 (Alloy C-276).

In special cases, titanium or tantalum are the only alternative.

### Material 2.4856 (Alloy 625)

Expansion joint bellows that are exposed to seawater are preferably made of Alloy 625. The molybdenum-containing material 2.4856 has excellent resistance to pitting, crevice corrosion and stress corrosion cracking.

### Material 2.4610/2.4819 (Alloy C-4/C-276)

Bellows of these two materials are used in chemical and other process engineering plants. They are exceptionally resistant to hot acids, chloride-containing solutions or even chlorine gas up to temperatures of 400 °C.

# MATERIALS FOR HIGH TEMPERATURES

For higher temperatures (>550 °C), where high scaling resistance is required, high-temperature or heat resistant steels are taken into consideration if they have adequate forming properties (e.g. 1.4828, 1.4876 or 2.4856).

03

## Material 1.4828

The material 1.4828 has proven itself as strip-wound hose liner in decoupling elements and as expansion elements in manifolds of engines. Owing to its high silicon content, 1.4828 has good scaling resistance.

## Material 1.4876 (Alloy 800 H)

The material 1.4876 is used where pressure loads occur in addition to high temperatures, e.g. in the inlet and outlet pipes of engine turbochargers. 1.4876, in which aluminium is added, has even better scaling resistance than 1.4828. Moreover, the chromium and nickel content is also significantly higher, but this makes it more expensive and reduces its suitability for forming. 1.4876 exhibits excellent creep rupture strength characteristics and is approved for components under pressure loads at temperatures above 550°C.

## Material 2.4856 (Alloy 625)

If corrosive demands and high temperatures occur combined, the use of nickel-base alloy 2.4856 is frequently recommended.

# EXPANSION JOINTS FOR AGGRESSIVE MEDIA

03

## Suitability of metal expansion joints

Expansion joints with corrugated metal bellows are basically suitable for transporting critical fluids under pressure and temperature. The flexibility of the corrugated expansion joint bellows generally requires their wall thickness to be considerably smaller than all other parts of the system in which they are installed. As increasing the bellows' wall thickness to prevent damage caused by corrosion is not reasonable, it becomes essential to select a suitable material for the bellows element, which is sufficiently resistant against all expectable aggressive media during the entire lifetime. In many cases the bellows has to be manufactured from a material with even higher corrosion resistance than those of the system parts it is connected to.

In addition, possible corrosive environmental effects must be considered.

The material selection must take into account all possible kinds of corrosion, especially pitting, intercrystalline corrosion, crevice corrosion and stress corrosion cracking (SCC).

## Selection of a suitable material

The material for the bellows plies is to be selected according to the specific aggressiveness of the operating fluid or the surrounding atmosphere. Recommendations for material resistance can be found in the resistance tables in Chapter 18.

## Fittings, flange materials and materials for restraint hardware

When choosing materials for connection fittings, strength and welding properties are particularly important. For flanges and fittings, unalloyed steel and general structural steel is normally used. Where there are higher operating temperatures, heat resistant steels are used. Under higher stresses or lower temperatures, fine-grained steels and cryogenic steels are used.

Under corrosion-critical conditions, fittings of duplex steel, stainless ferritic or austenitic steels and nickel-based alloys are used.

## **Responsibility of the manufacturer for the suitability of expansion joints**

The expansion joints manufacturer is responsible for the design of the expansion joint according to the given pressure, temperatures and movements, and for the material concerning its formability and weldability.

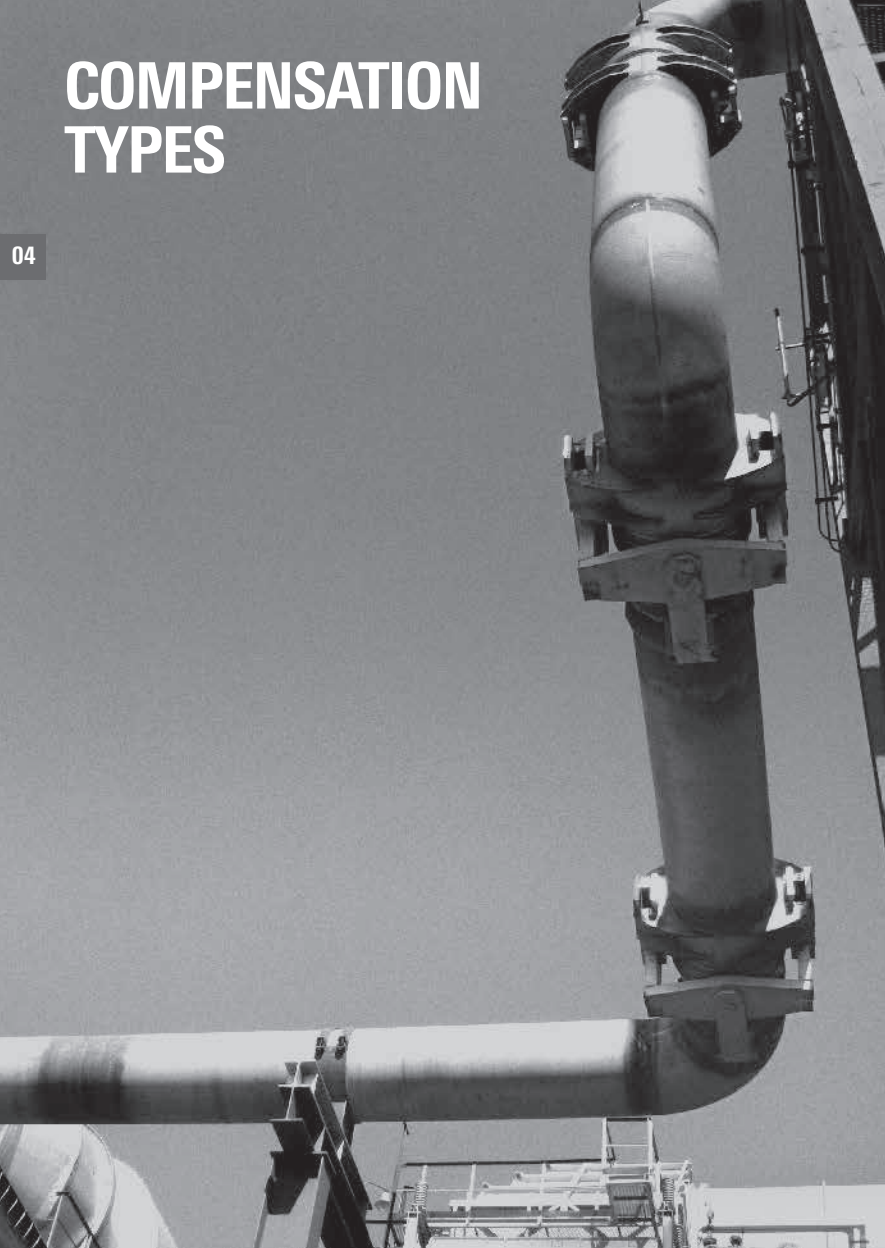
Witzenmann contributes its wide scope of experience when assisting the operator in selecting a suitable material.

With regard to the influences of the operating conditions given in the plant only the operator can take full responsibility. The advice of the expansion joint manufacturer can only be given without obligation, i. e. without any liability for the material to be selected for the specific application.



# COMPENSATION TYPES

04



In almost all technically oriented industrial sectors, expansion joints are needed for a safe operation of plants. They have to fulfil tasks, such as:

- Compensating thermal expansions in pipelines
- Decoupling vibrations of flexibly mounted aggregates from the connected systems
- Compensating relative movements between plant components elastically
- Insulating structure-borne noise
- Reducing forces and momentums at connections

The use of flexible, metallic expansion joints in modern plant and apparatus construction is not only necessary for technical reasons, it is equally important for meeting the demands of all industries for:

- Increased operating efficiency
- Reduced plant size
- Ease of installation
- Failure-free operation and
- Safety during incidents

HYDRA expansion joints meet all these requirements, and if chosen carefully and installed correctly are:

- Pressure resistant
- Vacuum-tight
- Temperature-resistant
- Corrosion-resistant
- Highly durable
- Reliable
- Maintenance-free

A comprehensive range of standard expansion joints are available. Our experienced engineers are always ready to examine the availability of specific designs for special applications. Their experience is based on decades of company experience in almost all branches of industry.

### Engineering for the specific case

We are always willing to support you in optimising your compensation problems, as far as a feasible solution can be found. We also offer a special engineering service for solving specific problems:

- Optimisation of compensation systems using modern methods of pipe calculation
- Optimisation of the design of bellows and connection parts for special applications, supported by FE methods
- Development of special designs, including the necessary manufacturing processes (forming, welding, etc.)
- Performing a series of tests with special products or for special applications
- Support in solving corrosion issues, including material recommendations and corrosion tests

### Compensation types and selection criteria

There are three basic types of compensation, namely:

- Compensation by elastic bending of pipe legs ("natural compensation")
- Axial expansion joints
- Restrained expansion joints (hinged expansion joints)

The relevant criteria are as follows:

- Magnitude and type of movement to be compensated
- Pipeline routing
- Forces and momentums acting on anchors and connections
- Installation space required for expansion joints
- Overall cost of compensation
- Assembly issues

This overview of criteria permits a qualitative comparison of the compensation types – either compensation with axial expansion joints or compensation with restrained expansion joints –and is an important decision-making aid.

## Compensation by pipe bending

The question whether compensation, for example thermal expansion, is possible by the intrinsic elasticity of the pipe system is generally superfluous due to the fact that with large diameters pipe legs which are sufficiently long are not available (Fig.4.1). Extending the pipes artificially or laying them with bends is however usually not feasible for economic reasons, as demonstrated by numerous analyses. High-pressure steam pipes in power stations are one example of an exception made for technical reasons.

An examination can generally be restricted to pipe diameters less than DN 100, and is only advisable if, in addition to the stresses from internal pressure, the pipes can also absorb significant, alternating stresses from movement cycles without fatiguing prematurely.

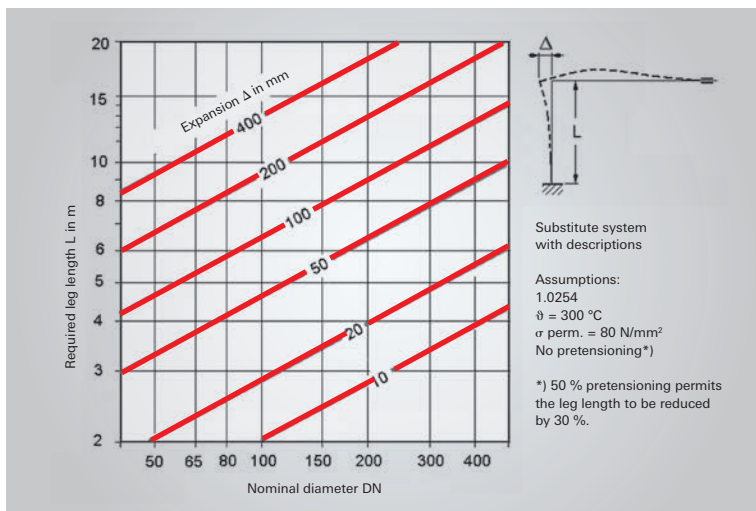


Fig. 4.1 Compensation by bending pipe legs ("natural compensation")

# COMPARISON OF COMPENSATION TYPES

## Axial expansion joints

Movement absorption:

- Small to medium axial movement absorption up to approx. 200 mm
- Additional lateral and angular movement absorption is possible
- Several axial expansion joints must be distributed over the length of the pipe section for large movements caused by long sections

Pipeline routing:

- No change in flow direction

Anchors and guides:

- Higher pressures and nominal diameters result in high anchor forces (Fig. 4.2)
- Anchors must be positioned at the corners of bent systems
- Long pipe sections with several axial expansion joints require intermediate anchor points
- Additional guides must be incorporated directly at the axial expansion joint

Installation space:

- Low space requirement, outside diameters only slightly larger than the pipe itself

Costs:

- Low price per unit (several expansion joints required for long pipe sections)
- Possibly high costs for anchors and guides

Assembly:

- Simple assembly and pretensioning of expansion joints
- Pipe sections must be guided exactly to give proper alignment
- Pressure test only possible when fully secured at anchors

## Restrained expansion joints

Movement absorption:

- Medium to large perpendicular to the expansion joint axis, on one plane or on all planes (main elongation absorbed by lateral expansion joint, small residual elongations absorbed by the pipe)

Pipeline routing:

- Pipeline rerouting necessary
- Compensation with hinged expansion joints advisable if the pipe routing already contains bends

Anchors and guides:

- Relatively small load on anchors, even in pipes with high pressure, since the axial pressure thrust is absorbed by the restraint hardware
- Only the adjustment force of the expansion joints and the frictional forces of the supports are relevant
- The frictional forces may cause problems in long pipes with regard to the design of the anchors
- Normal guides are sufficient for the pipe (when lateral expansion joints are used, this results in additional forces and momentums on anchors and guides due to residual elongations)

Installation space:

- More installation space required than with axial compensation, especially if the pipeline must be rerouted

Costs:

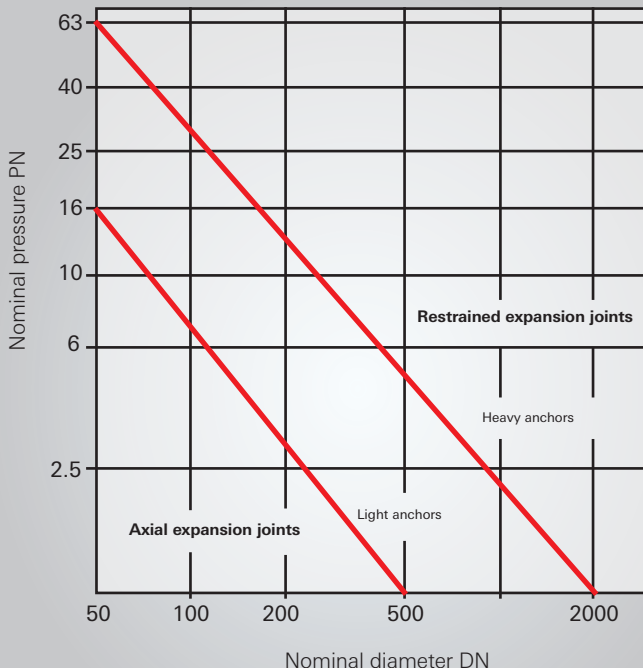
- Price per unit is higher than for axial expansion joints
- Angular expansion joints must be installed in pairs as a minimum
- In relation to movement, costs are comparable with those of axial expansion joints, if long pipe runs are compensated
- Anchors are cheaper

Assembly:

- Assembly of hinges is more complex
- Position of pivots and tie rods is very important
- Normal amount of work for pipe guiding
- Pressure test can be performed without anchors

# OPERATING LIMITS OF AXIAL EXPANSION JOINTS

Fig. 4.2 provides a rough idea of the potential use of axial expansion joints in pipes. Please note the assumptions which have been made. A more detailed examination of the technical boundary conditions and a cost comparison are generally advisable before a final decision is taken. The most important criterion is the anchor force.



#### Assumptions:

- A permissible anchor force of 10 - 20 kN has been assumed for "light anchors", depending on the nominal diameter (building, pipe bridges, pipe connections)
- An anchor force of approximately 40-400 kN has been assumed for "heavy anchors" depending on the nominal diameter (e.g. pipelines laid in ducts)

Fig. 4.2 Operating limits of axial expansion joints

## Anchor force

When axial expansion joints are used, the anchor force is made up of the axial pressure thrust  $F_p$ , the axial adjusting force  $F_\delta$  and the friction of the supports  $F_R$ ; these are calculated as follows:

### Axial pressure thrust in kN

(see also Fig. 4.3)

$$(4.1) \quad F_p = 0.01 A \cdot p$$

Effective cross-section  $A$  in  $\text{cm}^2$  (taken from dimension tables for axial expansion joints)

Pressure  $p$  in bar (maximum pressure, e.g. test pressure, should be used)

### Axial adjustment force in kN

$$(4.2) \quad F_\delta = 0,001 c_\delta \cdot \delta$$

Axial spring rate  $c_\delta$  in N/mm (taken from dimension tables for axial expansion joints)

Half overall deflection  $\delta$  in mm (with 50% pretensioning)

### Friction resistance of supports in kN

$$(4.3) \quad F_R = \Sigma F_L \cdot K_L$$

Support load  $F_L$  in kN

Friction coefficient of supports  $K_L$

Empirical values for  $K_L$ :

Steel / steel: 0.2 – 0.5

Steel / PTFE: 0.1 – 0.2

Roller bearings: 0.05 – 0.1

The significant share of the anchor force when axial expansion joints are used is contributed by the axial pressure thrust. The adjusting force is relatively insignificant in the multi-ply bellows we use.



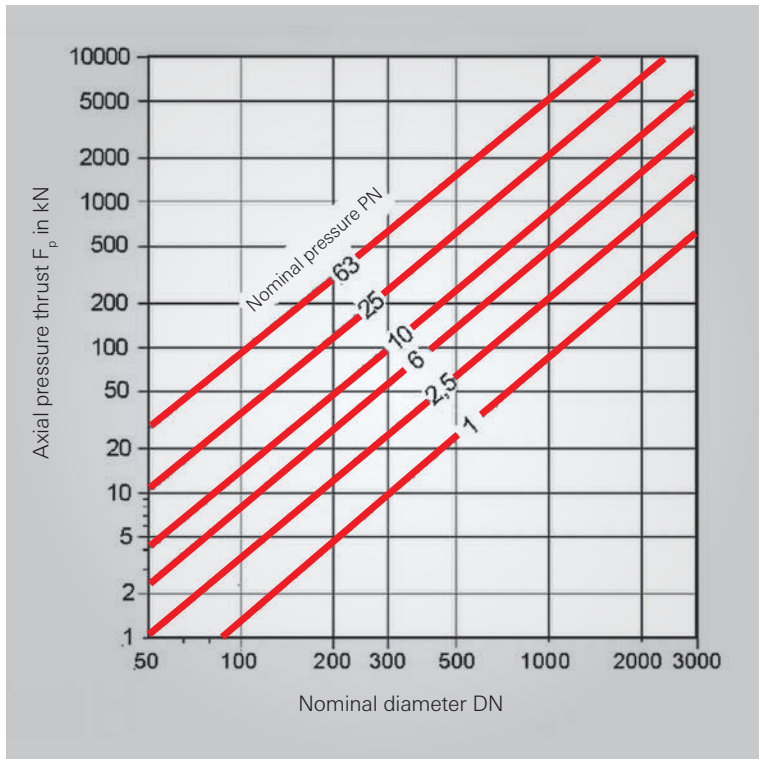


Fig. 4.3 Axial pressure thrust

## Adjusting forces and moments

Adjusting forces and adjusting moments for expansion joints should be calculated using the spring rates given in the tables. The values given there are valid for the cold state (ambient temperature) only; smaller values must be expected in the operating condition, which is why the values given in the tables can be used for piping calculations. The deviations are practically negligible for temperatures up to 200 °C. At higher temperatures the reduction factors in the table below enable the spring rate to be estimated when using standard materials (1.4541 or 1.4876). In the case of very large deflections or operating pressures, the manufacturer should be involved during the calculation of the adjusting forces or moments.

### Reduction factors for spring rates

Operating temperature $\vartheta$ in °C	200	300	400	500	600	700	800	900
Reduction factor $K_c$	0.93	0.9	0.86	0.83	0.80	0.75	0.71	0.67

### Spring rate at temperature

$$(4.4) \quad c_{i\vartheta} = K_c \cdot c_i$$

General spring rate  $c_i$  (taken from dimension tables)

## RESTRAINED EXPANSION JOINTS

If restrained expansion joints are used, no load is placed on the pipe anchors by the axial pressure thrust. The load is transferred by the restraint hardware instead. The only loads placed on the anchors are the adjusting forces of the expansion joints and the friction of the supports, as well as any forces and moments resulting from movements of the pipe legs if residual elongations are transferred to the pipes in conjunction with lateral expansion joints. The friction resistance of the supports may become significant in this case, since the movement in long pipe sections can be transferred to a single compensation system, thereby moving several different supports.

### Compensation with angular and lateral expansion joints

Restrained expansion joints have been considered so far as a single group, i.e. no distinction has yet been made between angular and lateral expansion joints. The basic question is whether a double-hinge system is sufficient for compensation or full compensation with three hinges is necessary.

Two hinges (angular expansion joints) – or alternatively one lateral expansion joint – can be used if the residual elongation from the pipe offset and the axial offset of the double hinge system resulting from the movement can be absorbed by the adjacent pipe legs by means of bending (see also Fig. 4.1), and if the forces and moments which are generated as a result can be taken by the system. The question as to whether it is better to use two hinges or one lateral expansion joint is generally related primarily to costs.

## Compensation with pressure balanced expansion joints

In some cases pressure balanced expansion joints or straight section tie rods are the technically favorable but possibly more expensive alternative. The basic possibilities which are available are described in Chapter 12, "Axial Pressure Thrust and Pressure-balanced Designs".

The criteria for selecting the right type of compensation system which are discussed in this chapter should be sufficient in most practical situations to clarify which types of expansion joint should be used. The final decision may however depend on other data, for example on the total length of the expansion joints, which is determined later on. This frequently makes it necessary to revise the overall system. Drawing up a cost comparison is the only means of choosing the most economical of all the technically feasible systems. An economic consideration should not merely take into account the cost of the expansion joints; it should also include all miscellaneous costs related to the selected compensation type, namely:

- Anchors
- Guides and other supports
- Constructions/shafts
- Assembly work
- Miscellaneous

In case of doubt or complex applications please consult our specialists.

# SYMBOLS USED TO REPRESENT SYSTEMS

## Expansion joint symbols

Designation	Plane illustration according to direction of movement		Isometric illustration
	in focal plane	perpendicular to the focal plane	
Axial expansion joint			
Angular expansion joint, single hinge			
Angular expansion joint, gimbal hinged			
Lateral expansion joint, flexible on one plane			
Lateral expansion joint, flexible on all planes (in circular plane)			

Fig. 4.4

## Support symbols

Designation	Display	Designation	Display
Anchor/Fixed point FP Intermediate anchor ZFP		Pipe shoe AL	
Sliding anchor GFP		Roller bearings RL	
Guide bearing FL		Spring hanger FH	
Two-way guide slide bearing KGL		Constant hanger KH	

Fig. 4.5

# OVERVIEW OF THE MOST IMPORTANT COMPENSATION TYPES

## Principle characteristics

### Axial compensation (Fig. 4.6)

- Simple design
- Small to medium movement absorption
- Movement on all sides possible
- No rerouting of pipeline necessary
- High axial forces in conjunction with high pressure
- Strong anchors and good guides necessary

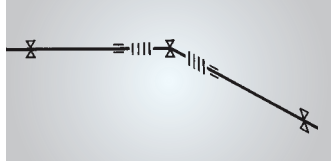


Fig. 4.6

### Angular compensation (Fig. 4.7)

- Complex design
- Medium to large movement possible
- Axial movement not possible
- Pipeline rerouting necessary
- Relatively small load on anchors
- Normal guides adequate

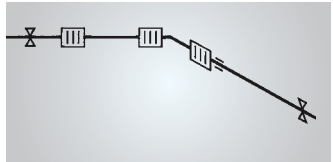


Fig. 4.7

### Lateral compensation (Fig. 4.8)

- Relatively simple design
- Small to medium movement absorption
- Axial movement not possible
- Pipeline rerouting necessary
- Relatively small load on anchors
- Additional load from residual elongations
- Normal guides adequate (sometimes with clearance).

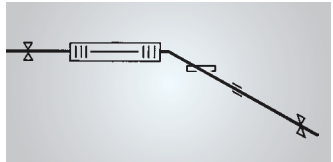
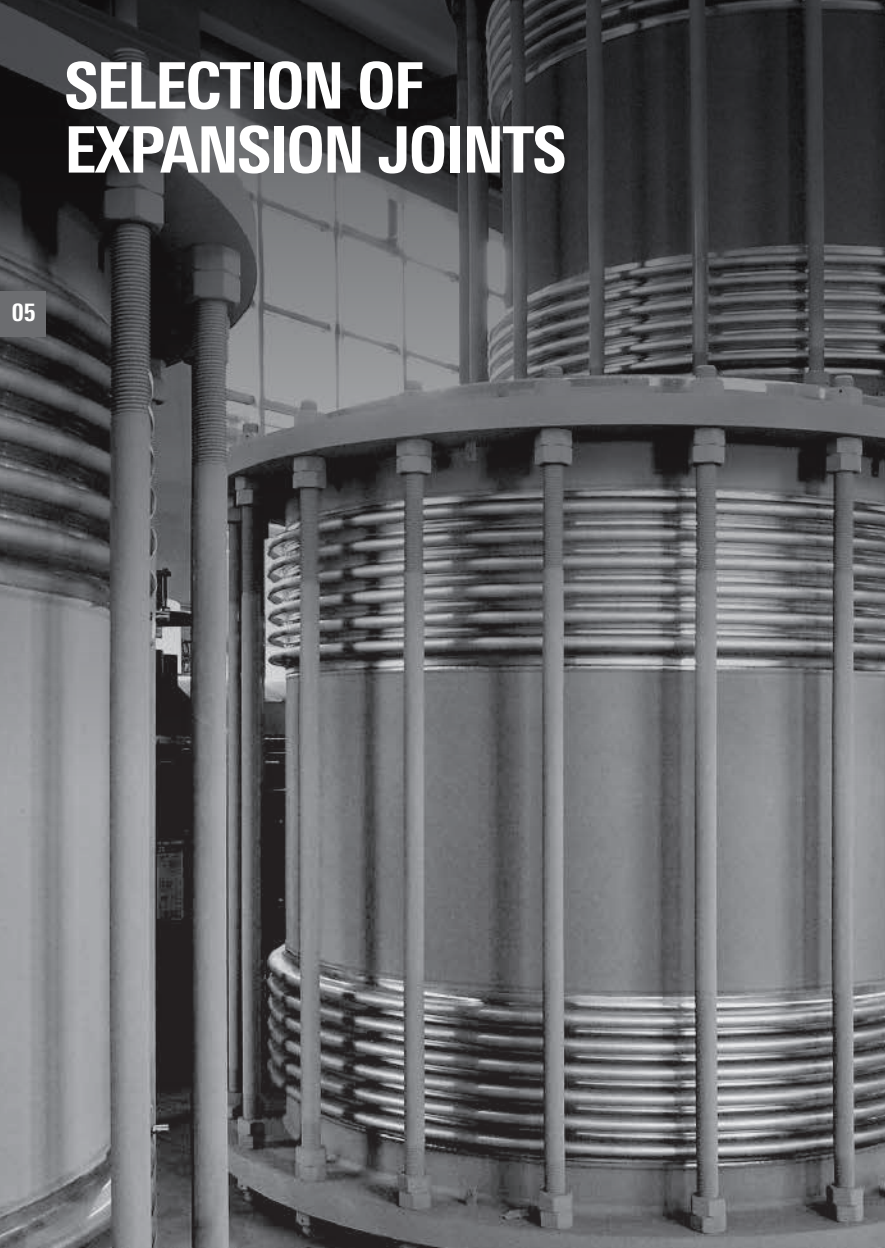


Fig. 4.8

# SELECTION OF EXPANSION JOINTS

05



The basis for selecting the right expansion joint is our comprehensive standard range, whose individual series are designed and arranged according to nominal diameter, nominal pressure and nominal deflection. This allows a fast and safe choice, guarantees cost-effective, well-constructed designs and ensures short and reliable delivery times.

Wherever an expansion joint has to be designed for a very particular application, our engineers optimise the design to meet the customer's engineering and economic specifications. Even in the initial quotation the exact dimensions are already determined.



## DESIGN REGULATIONS

The manufacturer is responsible for providing a properly designed expansion joint. "State-of-the-art" design is indispensable for complying with national and international standards. Since many pressurised pipelines are covered by the EU's Pressure Equipment Directive, the associated expansion joints are also classified as pressurised components as defined by the directive and have to be CE marked.

05

### **The Pressure Equipment Directive (PED)**

The PED applies to all expansion joints with a maximum permissible pressure  $PS > 0.5$  bar, unless their specific application does not explicitly exclude this. For this reason, even our standard expansion joints meet the additional requirements of the Pressure Equipment Directive.

Since our expansion joints can be used in a vast range of applications, we have designed them in such a way that they can be used in all categories up to category IV.

Witzenmann has implemented a quality assurance system as described in the PED Annex III, Module H/H1 for the scope of design, manufacturing and distribution of expansion joints and metal bellows.

This also applies to all other conditions, like certification of the raw materials, manufacturing processes and personnel. This means customers can rely on design and selection of expansion joints in compliance with the PED. The execution in accordance with the PED takes place in defined modules, which are selected depending on the category. Hence, the scope of testing and documentation is defined accordingly.

### **Witzenmann – Member of the EJMA**

Witzenmann is a member of the "Expansion Joint Manufacturers Association" (EJMA). Each expansion joint produced by Witzenmann can be designed and manufactured in strict accordance with EJMA standards.

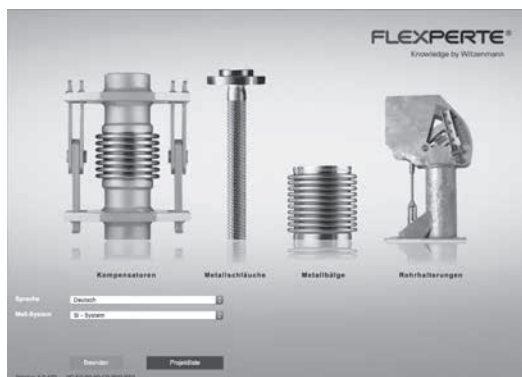
Detailed calculations to validate design in accordance with the latest edition of the EJMA standards are available to every customer.

# FLEXPORTE – KNOWLEDGE BY WITZENMANN

FLEXPORTE® is a design tool for flexible metal elements. It is a specially developed software in accordance with the latest design codes and selects the products from the standard range to suit the particular application. In addition to choosing the expansion joints, the user can also design metal bellows, flexible metal hoses and pipe supports with the program.

When the operating conditions have been entered, the program offers a selection of suitable products along with all necessary information and drawings for direct further processing in the form of an inquiry or an order.

05



A fully functional version of the program for direct use is available at [www.flexperte.com](http://www.flexperte.com).

# SYMBOLS USED IN FORMULAE

$\hat{a}$	Amplitude in mm
$c$	Spring rate
$c_{\delta}$	Axial spring rate in N/mm
$c_{\alpha}$	Angular spring rate in Nm/degree
$c_{\lambda}$	Lateral spring rate in N/mm
$c_f$	Friction factor in Nm/bar or N/bar
$c_p$	Pressure factor in Nm/Grad bar or N/mm bar
$c_{t\theta}$	Spring rate at temperature
A, B, C	Pipe sections in the hinge system in m
$D_a$	Bellows external diameter in mm
DN	Nominal diameter
$K_1, K_2, K_3$	Expansion joints in hinge system
$K_p$	Reduction factor for pressure
$K_{\Delta}$	Reduction factor for movement
$K_c$	Reduction factor for spring rate
$l$	Corrugated length of bellows in mm
$l^*$	Hinge distance / centre-to-centre distance of bellows in mm
$l_z$	Intermediate pipe length in mm
$L$	Length of a pipe section in m
$N$	Number of load cycles
PN	Nominal pressure
$P_A$	Operating pressure in bar
$P_P$	Test pressure in bar
$P_{RT}$	Cold pressure in bar
$R_{m/100000}$	creep rupture strength (100,000 hours until fracture) in N/mm <sup>2</sup>
$R_{p0.2}$	Yield strength with 0.2 % residual elongation in N/mm <sup>2</sup>
$R_{p,RT}$	Yield strength at ambient temperature in N/mm <sup>2</sup>
$R_{p,\theta}$	Yield strength at temperature in N/mm <sup>2</sup>
$\alpha$	Angular movement in one direction in degrees
$\bar{\alpha}$	Mean thermal expansion coefficient in mm/mK
$\alpha_o$	Pressureless bending angle in one direction in degrees
$\alpha_1, \alpha_2, \alpha_3$	Bending angles of expansion joints $K_1, K_2, K_3$ in degrees
$\delta_{RT}$	Axial movement in one direction (elongation or compression) in mm
$\delta_{RT}$	Cold value of axial movement in one direction in mm

$\Delta$	Movement, general in mm
$\Delta_P$	Pressure expansion in mm
$\Delta_{\vartheta}$	Thermal expansion in mm
$\Delta\vartheta$	Temperature difference in °C
$\lambda$	Lateral movement in one direction in mm
$\lambda_o$	Pressureless lateral movement in one direction in mm
$\vartheta$	Temperature in °C
$\vartheta_o$	Assembly temperature in °C
$\vartheta_A$	Operating temperature in °C
$\omega_a$	Axial natural frequency in Hz
$\omega_r$	Radial natural frequency in Hz

### Indices

o	pressureless, installation condition
c	for spring rate
calc	Calculated
A	Operating..., in relation to pipe section A
B	in relation to pipe section B
L	Dependent on number of cycles
N	Nominal ...
i	ith value of a value quantity, substitute pointer for index of the movement type
P	Pressure-dependent
RT	At ambient temperature
reqd	Required
z	Intermediate pipe
zul.	Allowable
$\alpha$	Dependent on angular movement
$\delta$	Dependent on axial movement
$\lambda$	Dependent on lateral movement
$\vartheta$	Temperature-dependent
$\Delta$	Movement-dependent

## PIPE SECTIONS

A pipe system must generally be subdivided into a number of suitable sections separated by anchors to ensure optimum compensation. The type of compensation must be taken into account here. Machines and vessels must be considered to be anchors if they are not flexibly supported.

### Axial compensation

Only straight pipe sections without offsets are permissible. Long, straight sections must be subdivided by intermediate anchors if several axial expansion joints are required to compensate the complete pipe section. Only one expansion joint must be installed between each pair of anchors (or intermediate anchors).

Anchors must be installed at the corner points at which pipelines are rerouted. A sliding anchor may be installed instead if the axial expansion joint (or a universal expansion joint) can be subjected to lateral movement (Figs. 5.1 and 5.2).

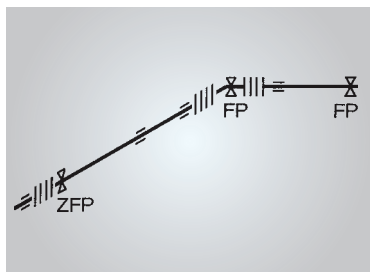


Fig. 5.1 Arrangement of axial expansion joints

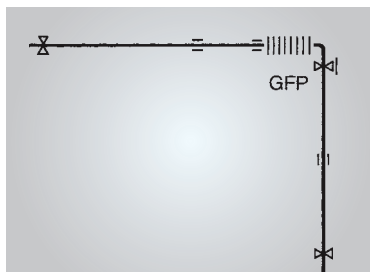


Fig. 5.2 Arrangement of a universal expansion joint

## Compensation with hinge systems

When a complex pipe system is subdivided into sections, the aim should be to achieve the basic subsystems shown in Figs. 5.3 to 5.5, namely U-system, L-system or Z-system. A straight pipe section is not suitable for compensation by hinged expansion joints. Thus, the pipeline is usually rerouted "artificially" by creating a U-system.

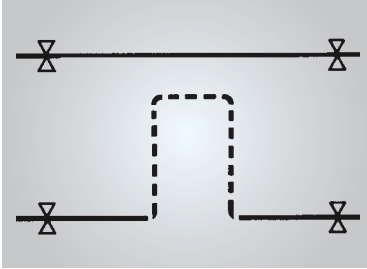


Fig. 5.3 Straight section, U-system

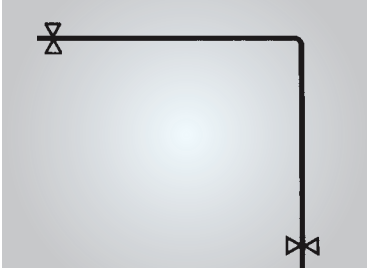


Fig. 5.4 L-system

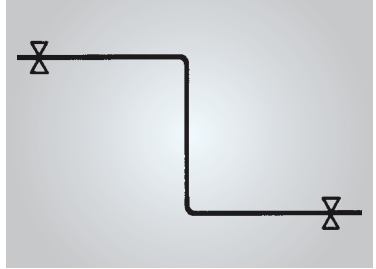


Fig. 5.5 Z-system

## DETERMINING MOVEMENT VALUES

Relative movements to be absorbed by expansion joints may be:

- Pressure expansion
- Vibrations
- Compensation of misalignment
- Subsidence of the foundation
- Thermal expansion

05

The greatest movement values are generally caused by thermal expansions. This will be dealt with separately and in detail below.

### Pressure expansion

Pressure expansion occurs at vessels and in pipelines as a result of a pressure load. It is, however, only significant in conjunction with large dimensions, which may have an important effect on compensation.

For estimating its magnitude it must be considered that in a long, closed cylinder the longitudinal stresses caused by pressure are half the magnitude of the circumferential stresses. If a full pressure utilisation is assumed, and taking the transversal contraction into account the following applies for standard steel with  $R_{p0,2} = 210 \text{ N/mm}^2$  and  $E = 21 \cdot 10^4 \text{ N/mm}^2$  and  $S = 1,5$  (safety factor for pressure vessels):

$$(5.1) \quad \Delta_p \approx 0.1 \text{ mm/m}$$

This value is generally negligible, except, for example, in extremely high columns or vessels, such as blast furnace, whose axial pressure stretch may result in lateral loads for expansion joints with large diameters in connecting pipes.

There is no pressure expansion in pipes with axial expansion joints due to the lack of a longitudinal force.

## Vibrations

Vibrations occur in machines where masses are moved (e.g. in turbo engines, piston engines and centrifuges). They are defined in terms of their frequency and amplitude. The frequencies are primarily dependent on the rotational speed. Furthermore, in this type of aggregate, it is possible to establish harmonic vibrations with a multiple of the speed but only a low amplitude.

The amplitudes of sustained vibrations in well-balanced machines are usually less than 1 mm, and are only higher temporarily during the start up phase and when traversing critical speeds (see also Chapter 13, "Vibrations and noise"). Centrifuges are an exception, in that considerably high vibration amplitudes can occur.

## Compensation of misalignment

Expansion joints can be used to compensate assembly inaccuracies, provided that this is taken into account when they are chosen. Since only a one-off movement must be compensated, it can be theoretically be borne by the expansion joint without any impact on its service life. In practise, however, the corrugations can very soon become either fully or partially blocked, which means that normal movement will be impeded and the expansion joint will fail at a relatively early stage. This risk is especially high if a relatively short axial expansion joint is used to compensate lateral misalignments.

## Subsidence of the foundation

Foundation or ground subsidences are also normally one-off movements, and may thus be greater for an expansion joint than the values specified for 1000 load cycles. If a one-off foundation subsidence is the only movement which is expected, even excessive forming of the corrugations may be acceptable, and the expansion joint will remain tight. Subsidences that occur when tanks are filled and which disappears again when they are drained must be dealt with according to the load cycles in the same way as other compensation movements.

If space must be created for assembling or dismantling components, suitable types of expansion joint can be used, namely so-called demounting parts (see Chapter 8, "Custom-built Design", Fig. 8.16). The assembly procedures are generally so infrequent that the expansion joint can withstand large movements (until the corrugations are blocked).



## Thermal expansions

The linear thermal expansion of metal components, referred to a temperature difference, can be determined by means of the material-related expansion coefficient.

**Thermal expansion**  $\Delta_{\vartheta}$  in mm

$$(5.2) \quad \Delta_{\vartheta} = L \cdot \bar{\alpha} \cdot \Delta\vartheta$$

05

Component length  $L$  in m (e.g. pipe section between two anchors)

Mean thermal expansion coefficient  $\bar{\alpha}$  in mm/mK (see Fig. 5.6)

Temperature difference  $\Delta\vartheta$  in K (difference between operating temperature and assembly temperature)

Material	Temperature range from 20 °C to				
	100 °C	200 °C	300 °C	400 °C	500 °C
Ferrite	0.0125	0.013	0.0136	0.0141	0.0145
Austenitic steels 1.4541	0.016	0.0165	0.017	0.0175	0.018
Copper	0.0155	0.016	0.0165	0.017	0.0175
Aluminium alloy (AlMg3)	0.0237	0.0245	0.0253	0.0263	0.0272

Fig. 5.6 Mean thermal expansion coefficient  $\bar{\alpha}$  in mm/mK

## Taking assembly temperature into account

The assembly temperature can normally be taken to be  $\vartheta_0 = 15$  to  $20$  °C when determining the temperature difference  $\Delta\vartheta$ , which must be taken into account in the movement calculation. At low operating temperatures of around  $100$  °C, it is necessary to proceed somewhat more precisely and to take a mean downtime temperature. A check must also be made to determine whether the pipe can still contract sufficiently at the lowest possible downtime temperature without the expansion joints being overstretched or the hinge system being geometrically overloaded. Particular attention must be paid to the possible extreme positions of the expansion joint or of the compensation system at the maximum and minimum outside temperatures, as well as to correct pretensioning at the prevailing assembly temperature in pipes which are usually cold and which only stretch or contract as a result of the prevailing outside temperature.

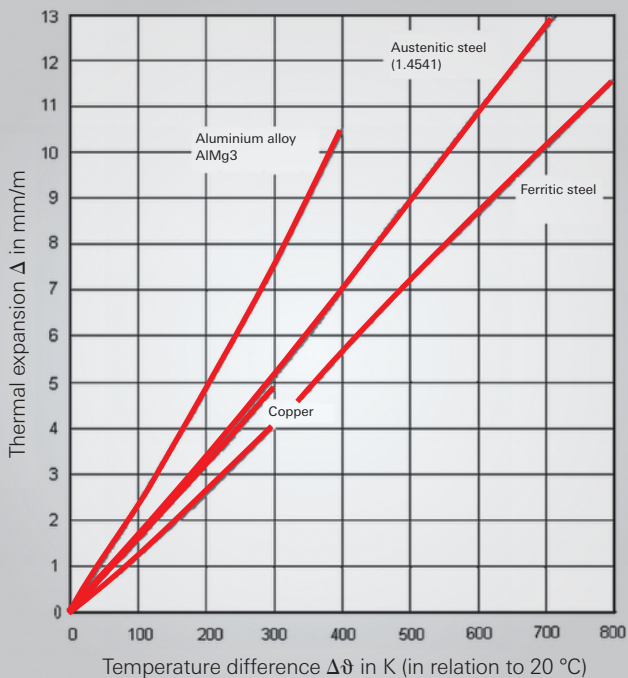


Fig. 5.7 Thermal expansion of metals

## REAL MOVEMENT VALUES

The real deflection of the individual expansion joints can be determined from the previously established relative movements – usually thermal expansion – in the various pipe sections.

### Axial and lateral movement absorption

If axial or lateral expansion joints are used, the movement values which are determined correspond to the real expansion joint deflections.

### Angular absorption of movements

The movement values  $\Delta$  must be converted to angular movements for hinge systems. A good approximation can be achieved with the aid of the graph below in Fig. 5.9.

The conversion is exact if the system is a simple double-hinge system with hinges arranged perpendicularly above one another. In other systems the angles are determined approximately, whereby the difference in relation to the exact angles is small and dependent on the arrangement of the hinges and at the magnitude of the movement which must be absorbed. The relevant movement value  $\Delta$  must first be determined for the particular hinge system in accordance with Fig. 5.8a, 5.8b. Together with the hinge distances A and B, the expansion joint angle  $\alpha$  must then be read from the graph (Fig. 5.9).

The hinge distances A and B should be as large as permitted by the overall construction, and should be such as to ensure small expansion joint bending angles and – above all – the smallest possible forces and moments in the pipe system. Distance C should be as small as possible.

The bending angles which are determined are real angles of the system at operating temperature, and are also valid when the cold system is pretensioned. If the system is to be operated without pretension, the angles obtained will be roughly twice as large, and correspondingly larger expansion joints will be necessary (Fig. 5.8a and 5.8b).

The real bending angles must be converted into nominal angles in order to select the best expansion joints, whereby the potential effects of the operating temperature, the pressure utilisation and the number of load cycles are taken into account.

Since this applies generally to all types of movement, the section below refers to all types of expansion joint.

### Definitions for Figs. 5.8a, 5.8b and 5.9

"Calculation of the bending angles of hinge systems"

#### Distances

- A Main distance
  - U and Z-systems: Distance between the hinges in or at the pipe offset
  - L-system: Distance between the hinges in the same pipe run
- B Secondary distance (three-hinge systems only)
  - all systems: Distance to the balancing joint
  - U-system: Distance basic hinge / crown hinge
- C Corner distance (three-hinge systems only)
  - all systems: Distance between hinges across the corner
  - U-system: Distance designated "B"

#### Hinges

- $K_1$  Outer hinge at section A
- $K_2$  Second hinge at section A
  - (U-system: second basic hinge)
- $K_3$  Second outer hinge/balancing joint (U-system: crown hinge)
  - Only exists in three-hinge systems!

#### Movements of the pipe strands

- $\Delta_1$  First main movement
  - Movement in first main section; assigned to  $K_1$
- $\Delta_2$  Second main movement
  - Movement in second main section
- $\Delta_3$  Secondary movement
  - Movement in pipe offset (Z-systems only)

## Calculation of the bending angles in hinge systems

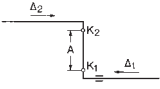
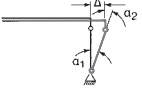
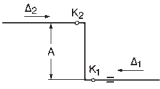
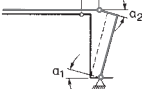

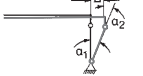
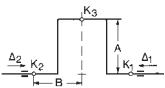
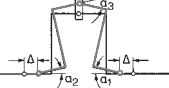
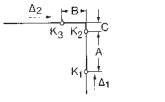
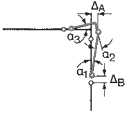
No.	Hinge system	Substitute system	Bending angle in degrees with 50% pretension
1	Double hinge 		$\Delta = \frac{1}{2} (\Delta_1 + \Delta_2)$ $\alpha_1 = (\Delta, A) \text{ cf. Fig. 5.9}$ $\alpha_2 = \alpha_1$
2	Double hinge in Z-arrangement 		$\Delta = \frac{1}{2} (\Delta_1 + \Delta_2)$ $\alpha_1 = (\Delta, A) \text{ cf. Fig. 5.9}$ $\alpha_2 = \alpha_1$
3	Double hinge 3-dimensional 		$\Delta = \frac{1}{2} \sqrt{\Delta_1^2 + \Delta_2^2}$ $\alpha_1 = (\Delta, A) \text{ cf. Fig. 5.9}$ $\alpha_2 = \alpha_1$
4	Three-hinge in U-arrangement 		$\Delta = \frac{1}{4} (\Delta_1 + \Delta_2)$ $\alpha_1 = (\Delta, A) \text{ cf. Fig. 5.9}$ $\alpha_2 = \alpha_1$ $\alpha_3 = 2 \cdot \alpha_1$
5	Three-hinge in L-arrangement 		$\Delta_A = \frac{1}{2} (\Delta_2 + \Delta_1 \frac{C}{OM})$ $\Delta_B = \frac{1}{2} \Delta_1$ $\alpha_1 = (\Delta_A, A) \text{ cf. Fig. 5.9}$ $\alpha_3 = (\Delta_B, B) \text{ cf. Fig. 5.9}$ $\alpha_2 = \alpha_1 + \alpha_3$

Fig. 5.8a

No.	Hinge system	Substitute system	Bending angle in degrees with 50% pretension
6	Three-hinge in Z1-arrangement 		$\Delta_A = \frac{1}{2} (\Delta_1 + \Delta_2 + \Delta_3 \frac{C}{OM})$ $\Delta_B = \frac{1}{2} \Delta_3$ $\alpha_1 = (\Delta_{A'} A) \text{ cf. Fig. 5.9}$ $\alpha_3 = (\Delta_{B'} B) \text{ cf. Fig. 5.9}$ $\alpha_2 = \alpha_1 + \alpha_3$
7	Three-hinge in Z2-arrangement 		$\Delta_A = \frac{1}{2} (\Delta_2 + \Delta_1)$ $\Delta_B = \Delta_3 \frac{C}{A}$ $\alpha_1 = (\Delta_{A'} A) \text{ cf. Fig. 5.9}$ $\alpha_3 = (\Delta_{B'} B) \text{ cf. Fig. 5.9}$ $\alpha_2 = \alpha_1 + \alpha_3$
8	Three-hinge 3-dimensional 		$\Delta_A = \frac{1}{2} (\sqrt{\Delta_1^2 + \Delta_2^2} + \Delta_3 \frac{C}{OM})$ $\Delta_B = \frac{1}{2} \Delta_3$ $\alpha_1 = (\Delta_{A'} A) \text{ cf. Fig. 5.9}$ $\alpha_3 = (\Delta_{B'} B) \text{ cf. Fig. 5.9}$ $\alpha_2 = \alpha_1 + \alpha_3$

Fig. 5.8b

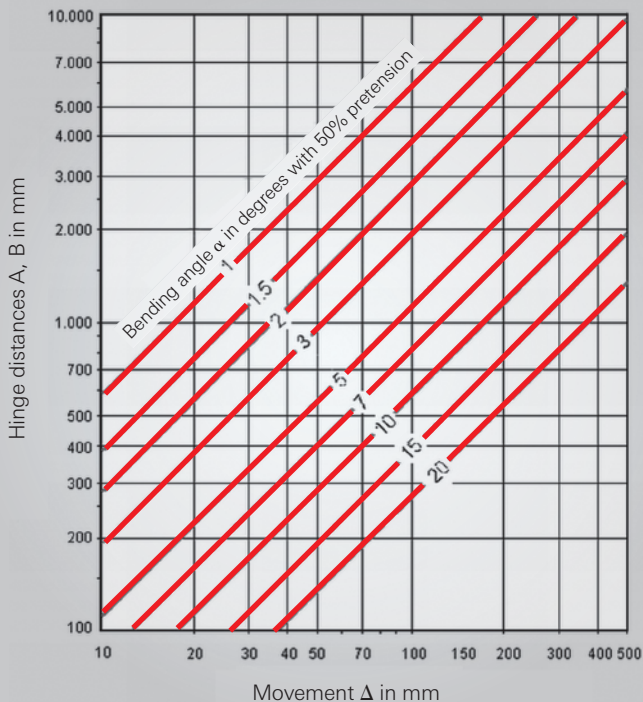


Fig. 5.9 Bending angles in hinge systems

## Universal movement absorption

Single axial expansion joints and universal expansion joints comprising two bellows connected via an intermediate pipe can cope with all types of movement - axial, angular and lateral. The movement absorptions (axial, angular, lateral) stated in our standard range described subsequently are to be regarded as alternatives, i.e. the sum of their proportions in percentages shall not exceed 100 %.

If any additional requirements must be met, combinations of multiple axial and universal expansion joints can be designed.

The calculation formulae for permissible angular or lateral movements, equivalent to the nominal axial movement  $2\delta_N$ , are specified together with equations for determining the spring rates for these types of movement (extremely good approximated).

***It is important to remember that the pressures valid for axial expansion joints are hardly ever permitted for universal expansion joints.***

The necessary pressure reductions are shown in the graphs below (Fig. 5.11 and 5.14).

### Bending angle (cf. Fig. 5.10)

Single bellows

$$(5.3) \quad 2\alpha_o = 2\delta_N \frac{115}{D_a}$$

Bending angle, pressureless  $2\alpha_o$  in degrees

Overall, nominal axial movement  $2\delta_N$  in mm

Bellows outside diameter  $D_a$  in mm

The permissible cold pressure for an angular movement is dependent on the maximum, effective bending angle  $\alpha$ , and can be read from the graph in Fig. 5.11 in relation to the nominal pressure.



05

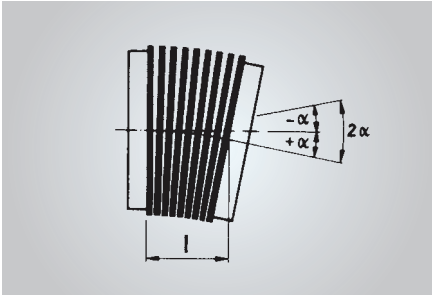


Fig. 5.10 Single bellows, angular

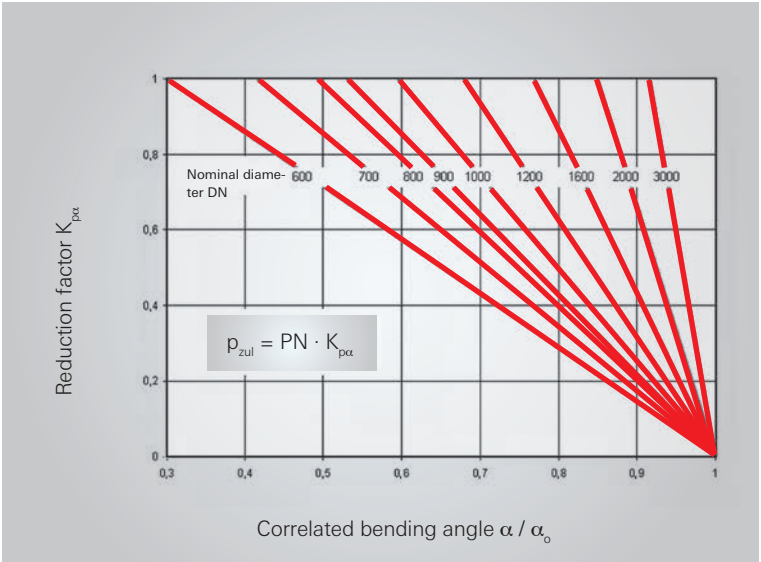


Fig. 5.11 Pressure reduction for single bellows during angular movement

**Spring rate**  $c_{\alpha}$  in Nm/degree

Single bellows

$$(5.4.) \quad c_{\alpha} = c_{\delta} \cdot 2.2 \cdot 10^{-6} \cdot D_a^2$$

Axial spring rate  $c_{\delta}$  in N/mm, bellows outside diameter  $D_a$  in mm

**Lateral movement** (cp. Fig. 5.12, 5.13)

05

Single bellows (no pressure reduction)

$$(5.5) \quad 2\lambda_N = 2\delta_N \cdot \frac{l}{3D_a}$$

Double bellows (consider pressure reduction according to Fig. 5.14!)

$$(5.6) \quad 2\lambda_o = 2\delta_N \cdot \frac{2}{3D_a} \cdot \frac{l^2 + 3l^2}{l + l^*}$$

Total lateral movement  $2\lambda_N$  or  $2\lambda_o$  in mm

Axial movement of the single bellows  $2\delta_N$  in mm

Corrugated length of single bellows  $l$  in mm

"Hinge" Distance  $l^*$  in mm ( $l^* = l + l_z$ , with intermediate pipe length  $l_z$ )

**Spring rate**  $c_{\lambda}$  in N/mm

Single bellows

$$(5.7) \quad c_{\lambda} = c_{\delta} \cdot \frac{3}{2} \left( \frac{D_a}{l} \right)^2$$

Double bellows

$$(5.8) \quad c_{\lambda} = c_{\delta} \cdot \frac{3}{4} \cdot \frac{D_a^2}{l^2 + 3l^2}$$

Spring rate of the single bellows  $c_{\delta}$  in N/mm (other values as defined above)

The permissible cold pressure for a lateral movement is dependent on the maximum effective lateral movement  $\lambda$  and can be read from the graph below (Fig. 5.14).

05

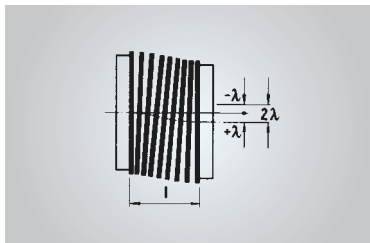


Fig. 5.12 Single bellows, lateral

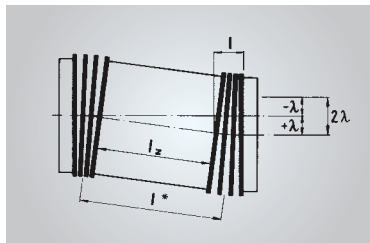


Fig. 5.13 Double bellows, lateral

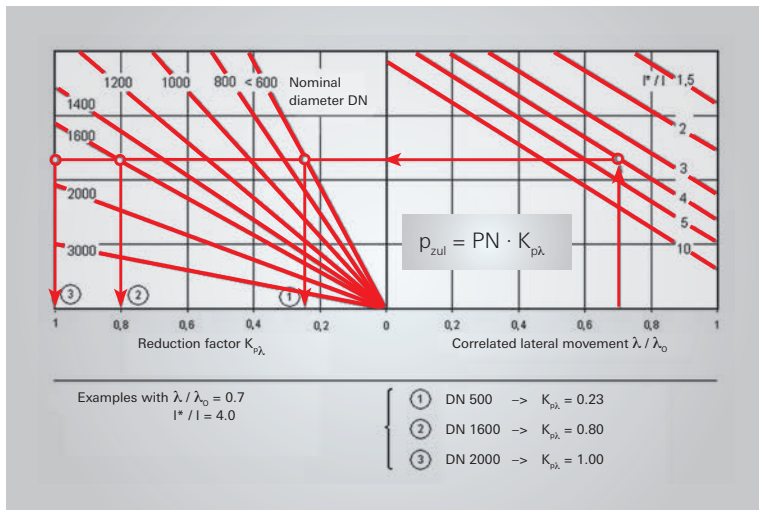


Fig. 5.14 Pressure reduction for universal expansion joint with two bellows during lateral movement

## NOMINAL DIAMETER DN

The nominal diameter of an expansion joint depends on the dimensions of the pipe or the flange connections. Select an expansion joint to suit these criteria.

The standard wall thicknesses of weld ends are given in the tables. These thicknesses meet the requirements of the nominal pressure rating. If possible, standard wall thicknesses of welded pipes according to DIN EN 10220 have been chosen.

Flanges with dimensions acc. to DIN EN 1092-1 are initially used. The flange thicknesses of loose flanges have been adapted in each case to suit the stresses prevailing in the expansion joint and in some cases are different to those of standard flanges.

Flanges with other dimensions are possible, e.g. to the US standard (ASME) or non-standard flanges for special machine connections. Flanges with pitch circle diameters smaller than those given in DIN EN 1092-1 must be checked to ensure that the bolting is compatible with the bellows side.

## NOMINAL PRESSURE PN

Our standard expansion joints are designed for a nominal pressure (PN) and arranged in PN ratings in the tables. (The nominal pressure parameter corresponds to the permissible operating pressure at ambient temperature, rounded to a PN nominal pressure rating according to DIN EN 1333. There are additional low pressure expansion joint types for PN1 available.) It is known that at higher temperatures the permissible pressure is lower than the nominal pressure because the characteristic strengths of the materials used are correspondingly lower at higher temperatures. The permissible pressure must be reduced accordingly.

The **reduction factor** is defined as:

$$(5.9) \quad K_{p\theta} = \frac{R_{p,\theta}}{R_{p,RT}}$$

$R_{p,\theta}$  yield strength in N/mm<sup>2</sup> at design temperature

$R_{p,RT}$  yield strength in N/mm<sup>2</sup> at ambient temperature

05

The yield strength  $R_p$  is valid for the strength parameter over a wide temperature range. At higher temperatures the creep rupture strength plays a role. Our expansion joints are designed in such a way that the reduction can be based on the material of the bellows.

The choice of a suitable nominal pressure is based on the **cold pressure**  $P_{RT}$ . This must not be greater than the nominal pressure:

$$(5.10) \quad PN \geq P_{RT} = PS/K_{p\theta}$$

PS maximum permissible operating pressure in bar

$K_{p\theta}$  pressure reduction factor based on operating temperature

The **test pressure**  $P_T$  must be at least equal to the larger of the two values given by the equations below:

for a water pressure test

$$(5.11) \quad P_T = \max \begin{cases} 1.25 \cdot PS \cdot \frac{f_0}{f} \\ 1.43 \cdot PS \end{cases}$$

for a gas pressure test

$$(5.12) \quad P_T = PS \cdot \frac{f_0}{f}$$

$f_0$  allowable stress in N/mm<sup>2</sup> for design conditions at test temperature

$f$  allowable stress in N/mm<sup>2</sup> for design conditions at design temperature

The expansion joints are designed to withstand a test pressure of 1.43 times their nominal pressure. If a higher test pressure is required, this must be taken into account when determining the PN rating.

Temperature in °C	Reduction factor $K_{p0}$	Standard material combinations				
		Bellows	Weld end	Flange	Restraint hardware	
20	1.00	1.4541	1.0345 (P235GH) seamless	1.0038 (S235JRG2)	1.0425 (P265GH)	
100	0.83			1.0460 (P250GH)		
150	0.78					
200	0.74					
250	0.71					
300	0.67					
350	0.64		1.5415 (16Mo3)		1.5415 (16Mo3)	
400	0.62					
450	0.61					
500	0.60		1.4541	1.4541	1.4541	
550	0.59		1.4876	1.4876	1.4876	1.4876
600	0.46					
650	0.32					
700	0.19					
750	0.14					
800	0.08					
850	0.06					
900	0.03					

Fig. 5.15 Pressure reduction factor for the pressure (temperature-related)

Basis:  $R_{p1.0}$  – values for 1.4541 (cold-rolled strip) according to DIN EN 10028-7

$R_{m100.000}$  – values for 1.4876 according to DIN EN 10095

## NOMINAL DEFLECTION AND NOMINAL ANGLE

Nominal values are to be calculated from the determined real movement values so that it is possible to choose a suitable expansion joint from the tables. The nominal values are based on a service life of at least 1000 full load cycles at ambient temperature and maximum pressure utilization, and are valid for the standard bellows material 1.4541.

A load cycle here means the total movement of the expansion joint from a starting position to an extreme position on one side, then returning via the starting point to an extreme position on the other side and then back to the starting position.

The service life is influenced by

- Pressure utilization
- Movement size
- Pressure pulsation

plus other factors whose effects cannot be calculated or are unacceptable, such as

- Thermal shock
- Corrosion
- Pre-existing damage (improper installation, damaged corrugations, etc.)
- Resonance (e.g. flow-induced)

A temperature up to 500 °C has no influence on the amount of movement. Please consult us for higher temperatures.

The correction factors given below are valid for the standard materials 1.4541 ( $\leq 550$  °C) and 1.4876 ( $> 550$  °C). Other materials with comparable strength values behave very similarly and can be handled in a similar way. Materials whose characteristic values deviate considerably from the values mentioned here cannot be dealt with in this way accurately enough. This frequently needs a different approach. Please consult us if you wish to use special materials.

Pressure ratio $P_{RT} / PN$	1	0.8	0.6	0.4	0.2	0
Correction factor $K_{sp}$	1.00	1.03	1.07	1.10	1.13	1.15

Fig. 5.17 Pressure influence on the amount of movement

Load cycles	Influencing factor $K_{\Delta L}$	Load cycles	Influencing factor $K_{\Delta L}$	Load cycles	Influencing factor $K_{\Delta L}$
500	1.15	10000	0.53	$5 \cdot 10^5$	0.20
1000	1.00	20000	0.44	$1 \cdot 10^6$	0.17
2000	0.82	$5 \cdot 10^4$	0.34	$2 \cdot 10^6$	0.14
4000	0.68	$1 \cdot 10^5$	0.29	$5 \cdot 10^6$	0.12
7000	0.58	$2 \cdot 10^5$	0.24	$1 \cdot 10^7$	0.11

Fig. 5.18 Influence of the load cycles on the amount of movement

## General correction factor

$$(5.13) \quad K_{\Delta} = K_{\Delta p} \cdot K_{\Delta L}$$

The entire correction factor  $K_{\Delta}$  must not be greater than 1.15.

## Required movement absorption cold

$$(5.14) \quad \text{axial: } 2\delta_{RT} = 2\delta / K_{\Delta} \leq 2\delta_N$$

$$(5.15) \quad \text{lateral: } 2\lambda_{RT} = 2\lambda / K_{\Delta} \leq 2\lambda_N$$

$$(5.16) \quad \text{angular: } 2\alpha_{RT} = 2\alpha / K_{\Delta} \leq 2\alpha_N$$

## Cummulated movement

If an expansion joint is to accommodate movements with different numbers of load cycles, the respective cold values (related to 1000 load cycles) are determined first. Afterwards, the theoretical total deflection of the cumulated movement can be calculated reasonably accurately using the following equation:

$$(5.17) \quad 2\delta_{RTges.} = [ \sum (2\delta_{RT,i})^4 ]^{1/4}$$

The cold movement and nominal pressure calculated as described above can now be used to select the necessary expansion joints from the standard range.



### Pressure pulsations

Pressure pulsations or dynamic operating pressure superimposed on the static pressure have an influence on the service life. Their effect, which can be calculated, depends on the magnitude of the pressure fluctuations in relation to the nominal pressure and their frequency. Generally, pressure fluctuations are negligible. However, if the magnitude and frequency of pressure surges are expected to have a detrimental effect on the service life, please consult us.

05

When designing expansion joints it is usual to check the utilisation condition (related to load cycles):

$$D = \sum (N_{i, reqd} / N_{i, calc}) \leq 1.$$

## MATERIAL

We have selected material combinations for standard expansion joints that are adequate for the majority of applications. The most important considerations for the choice of the bellows material are generally

- formability
- weldability
- temperature resistance
- strength
- corrosion resistance

Our standard material, 1.4541, an austenitic stainless steel, satisfies these requirements admirably for a wide range of requirements. For higher temperatures ( $\vartheta > 550 \text{ }^\circ\text{C}$ ), high temperature or heat-resistant steels can be used if they have sufficient ductility (e.g. 1.4876, 1.4828).

Under extremely aggressive conditions, special materials with a corrosion resistance at least equivalent to that of the adjoining pipe must be used. This is because the relatively thin plies of the bellows and their function as highly flexible compensation element does not permit any corrosion allowance. In case of doubt it is best to choose a higher-quality material for the bellows, at least for the inner ply. In many cases nickel-based alloys, with which we have had good experience, are suitable.

The choice of a suitable corrosion-resistant material should be based on the experience of the user, who is familiar with the particular characteristics of his system and his operating medium. The resistance tables in Chapter 18 can help with the selection. Please note that special materials with – in comparison to 1.4541 – completely different physical parameters (e.g. aluminium) will inevitably lead to different dimensions and performance data for the bellows.

### Low temperatures

The standard can be used in temperatures down to  $\vartheta = -10\text{ °C}$  without having to apply a reduction factor.

At lower temperatures low-temperature steels should be chosen for the ferritic parts. Fig. 5.16 specifies suitable materials approved to the EN 13445 or EN 917 standard that enable the expansion joint to be fully utilized. At very low temperatures down to  $\vartheta = -273\text{ °C}$  it is possible to use a design made completely from the austenitic material 1.4541.

Temperature in °C	bellows	Pipe	restraint hardware
-20	1.4541	P235GH	P265GH
-40		P355NL1	P355NL1
-273		1.4541	1.4541

Fig. 5.16 Materials for low-temperature applications EN 13445-2

## INNER SLEEVE

An inner sleeve is used to protect the bellows when deposits or abrasion are anticipated as well as if high flow velocities could excite the corrugations of the bellows and cause them to vibrate.

The diagram in Fig. 5.19 shows maximum values for flow velocities permissible without an inner sleeve. These figures are based on an unfavourable flow towards the corrugations.

05

The inner sleeve can also act as an internal guidance (in special versions) and is indispensable in such cases. In addition, it can also act as a support for an internal refractory lining, but in this case calls for a special design. If an inner sleeve is necessary but must not hinder lateral or angular movement, tapering or stepped sleeves can be incorporated (Fig. 5.20).

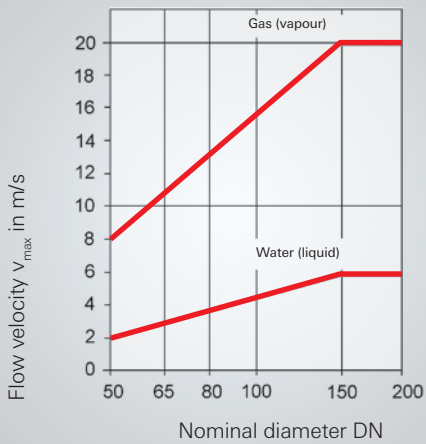


Fig. 5.19 Limiting values for usage of inner sleeves

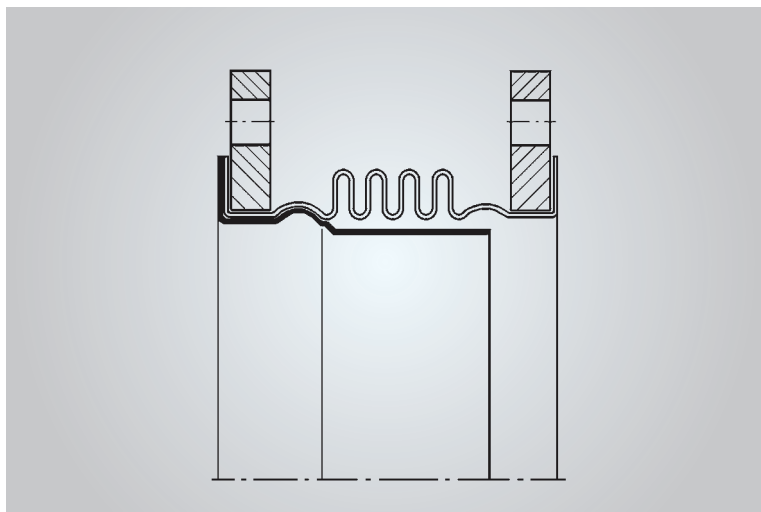


Fig. 5.20 Axial expansion joint with separate inner sleeve for lateral movement

# STANDARD RANGES



06

## General information

This manual deals with the expansion joints used for pipeline and for plant and apparatus construction. The expansion joints are designed for 1000 load cycles in line with the standard operation mode of thermal plants, which corresponds to 20 years operation if the plant is started up and shut down once a week. Other designs are also possible.

The HYDRA expansion joints described here cover the essential needs of industrial applications as part of our wide range of flexible metallic elements:

### Nominal diameters DN 15 – 3000

### Nominal pressures PN 1 – 63

Larger expansion joints up to 12 m in diameter as well as for higher pressures can be supplied on request.

The standard expansion joints are of different construction types, such as axial, angular and lateral expansion joints, and are listed separately according to type series; in addition to the construction type, the type series also specifies such features as the connection type and any particularities of the design. The individual type series are classified according to the nominal pressure rating, the nominal diameter and the movement value.

The design of the standard expansion joints, of which variants can be supplied on request is defined initially in relation to the connections and materials:

### Connections

Weld ends according to ISO

Flanges according to EN 1092-1

Connectors according to other standards (e.g. ASME) are possible with minor changes of the expansion joint characteristics.

### Materials

According to description of the individual types

### Axial/universal expansion joints for low pressure (exhaust)

- with flanges
- with weld ends

#### Series

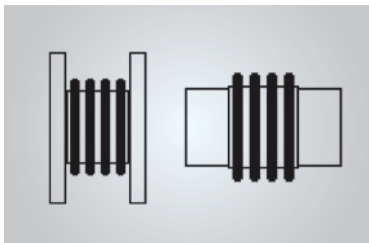
ABN/AFN (formerly ABG/AFG)

UBN/UFN (formerly ABG/AFG)

ARN/URN (formerly ABG/AFG)

#### Nominal diameters

DN50 – DN3000



#### Pressure ratings

PN1

#### Special features/main applications

Unrestrained expansion joints as inexpensive solutions for exhaust gas lines, with small spring rates and large movement absorption.

---

### Axial/universal expansion joints

- with flanges
- with weld ends

#### Series

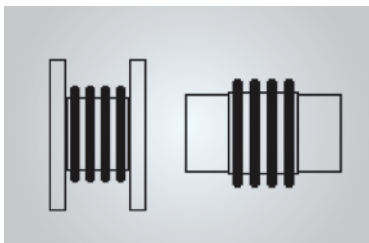
ABN/AFN

UBN/UFN

ARN/URN

#### Nominal diameters

DN50 – DN2000



#### Pressure ratings

PN2.5 – PN40

#### Special features/main applications

Unrestrained expansion joints for pipeline and plant construction, with small spring rates and large movement absorption.

## Angular expansion joints as single/gimbal hinge versions

- with loose flanges
- with plain fixed flanges

### Series

WBN/WBK

WFN/WFK

### Nominal diameters

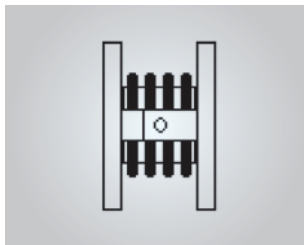
DN50 – DN800

### Pressure ratings

PN6 – PN25

### Special features/main applications

Large bending angle, short overall lengths for use in chemical plants.



06

---

## Angular expansion joints as single/gimbal hinge versions

- with weld ends

### Series

WRN/WRK

### Nominal diameters

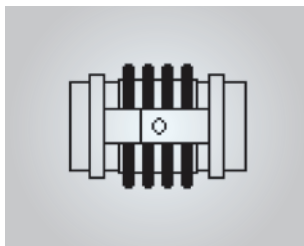
DN50 – DN800

### Pressure ratings

PN2.5 – PN63

### Special features/main applications

Large bending angle, short overall lengths, for use in pipeline and plant construction.





### Lateral expansion joints for movement in all planes (circular plane)

- with loose flanges
- with plain fixed flanges

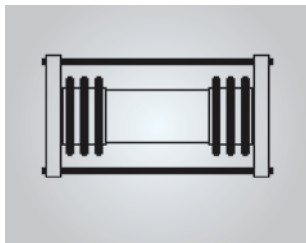
#### Series

LBR

LFR

#### Nominal diameters

DN50 – DN500



06

#### Pressure ratings

PN6 – PN25

#### Special features/main applications

Can move in all directions in a circular plane, for use in pipeline and plant construction, as connection to machinery.

---

### Lateral expansion joints for movement in one/all planes

- with weld ends

#### Series

LRR

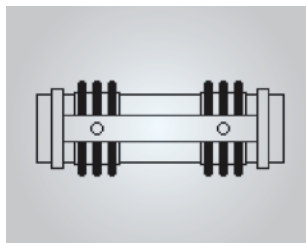
LRN/LRK

#### Nominal diameters

DN50 – DN2000

#### Pressure ratings

PN6 – PN63



#### Special features/main applications

Compact design, small spring rates for use in pipeline and plant construction.

## Sound insulating expansion joints

- with tie rods and loose flanges

### Series

LBS

### Nominal diameters

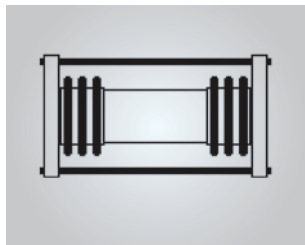
DN50 – DN400

### Pressure ratings

PN6 – PN25

### Special features/main applications

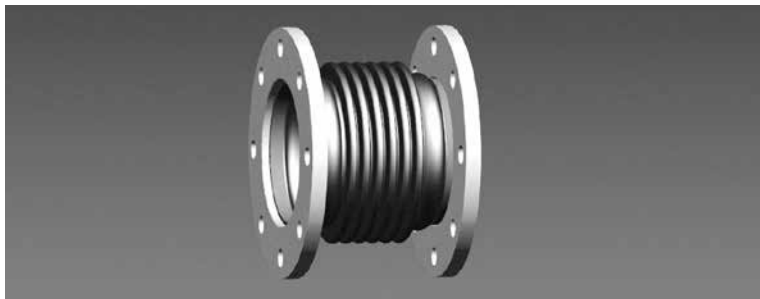
Sound insulating design for use with vibrating elements, pumps.



06

# AXIAL EXPANSION JOINTS FOR LOW PRESSURE (EXHAUST) WITH FLANGES TYPE ABN, AFN

06



## Type designation

The type designation consists of 2 parts

1. Type series, defined by 3 letters
2. Nominal size, defined by 10 digits

## Example

Type ABN: HYDRA low pressure expansion joint with loose flanges

Type AFN: HYDRA low pressure expansion joint with plain fixed flanges

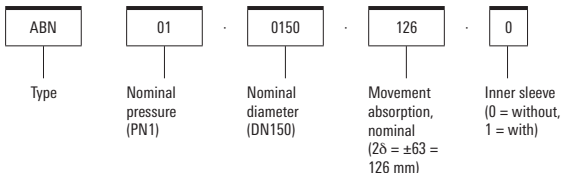
## Standard design/Materials

Multi-ply bellows made of 1.4541

Flange made of S235JRG2 (1.0038) or P250GH (1.0460)

Operating temperature: up to 550 °C

## Type designation (example)



## Order text

Please state the following with your order:

For standard versions

- Type designation or order number

With material variation

- Type designation
- Details of materials

The expansion joints for low pressure (exhaust-gas) are designed for unpressurized applications (PS < 0.5 bar gauge pressure).

The Pressure Equipment Directive (PED) does not apply to this operating condition.

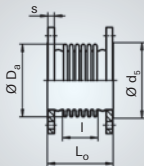
## Information

Tell us the dimensions that deviate from the standard and we customize the expansion joint to your specification.

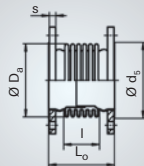
On request, flanges can also be supplied with other hole patterns / flange sheet thicknesses. In this case, the specified overall length L0 may change.

# AXIAL EXPANSION JOINTS FOR LOW PRESSURE WITH LOOSE FLANGES

Type ABN  
without inner  
sleeve



Type ABN  
with inner  
sleeve



06

Nominal diameter	Nominal axial movement absorption <sup>1)</sup>	Type ABN 01...	Order No. standard version		Overall length	Weight approx.		Flange <sup>2)</sup>		
			without inner sleeve	with inner sleeve		without inner sleeve	with inner sleeve	drilling template as per EN 1092	rim diameter	thickness
DN	2δN	-	-	-	L <sub>o</sub>	G	G	PN	d5	s
-	mm	-	-	-	mm	kg	kg	-	mm	mm
50	20	.0050.020.0	419285	419411	117	3.3	3.4	6	90	16
50	56	.0050.056.0	419286	419412	198	3.6	3.8	6	90	16
50	80	.0050.080.0	419287	419413	252	3.8	4.2	6	90	16
65	23	.0065.023.0	419289	419414	117	4.3	4.4	6	107	16
65	64	.0065.064.0	419290	419415	198	4.6	5	6	107	16
65	92	.0065.092.0	419291	419416	252	4.8	5	6	107	16
80	37	.0080.037.0	419292	419417	146	7	7	6	122	18
80	69	.0080.069.0	419293	419418	206	7	7	6	122	18
80	101	.0080.101.0	419294	419419	266	7	8	6	122	18
100	40	.0100.040.0	419295	419420	142	7	8	6	147	18
100	79	.0100.079.0	419296	419421	208	8	8	6	147	18
100	112	.0100.112.0	419297	419422	263	8	9	6	147	18
125	63	.0125.063.0	419298	419423	181	10	10	6	178	20
125	117	.0125.117.0	419299	419424	259	10	11	6	178	20
125	180	.0125.180.0	419300	419425	350	11	12	6	178	20
150	54	.0150.054.0	419301	419426	168	11	11	6	202	20
150	126	.0150.126.0	419302	419427	272	12	13	6	202	20
150	180	.0150.180.0	419303	419428	350	12	14	6	202	20
200	70	.0200.070.0	419304	419429	199	15	17	6	258	22
200	120	.0200.120.0	419305	419430	274	16	18	6	258	22
200	200	.0200.200.0	419306	419431	394	17	20	6	258	22

# TYPE ABN 01... PN 1

06

Bellows			Nominal movement absorption <sup>1)</sup>		Vibrations in all planes	Spring rate			Natural frequency of bellows	
outside diameter	corrugated length	effective cross-section	angular	lateral		axial	angular	lateral	axial	radial
Da	l	A	2α.N	2λ.N	â	cδ	cα	cλ	ωa	ωr
mm	mm	cm <sup>2</sup>	degree	mm	mm	N/mm	Nm/deg	N/mm	Hz	Hz
89	45	46	30	3.9	0.3	104	1.3	451	420	1800
89	126	46	50	31	1	37	0.5	20	150	230
89	180	46	50	63	1	26	0.3	7	105	110
107	45	68.7	28	3.7	0.3	101	1.9	654	350	1840
107	126	68.7	50	29	1	36	0.7	30	125	235
107	180	68.7	50	59	1	25	0.5	10	90	115
121	70	89.1	39	8.1	0.5	67	1.7	233	220	840
121	130	89.1	50	28	1	36	0.9	36	165	340
121	190	89.1	50	60	1	25	0.6	12	80	115
148	66	137	34	6.6	0.5	72	2.8	432	210	1050
148	132	137	50	26	1	36	1.4	54	90	220
148	187	137	50	53	1	26	1	19	60	110
174	91	187	45	12	0.5	41	2.1	177	120	520
174	169	187	50	43	1	22	1.1	28	70	150
174	260	187	50	101	1	14	0.7	7.4	40	65
203	78	264	33	7.7	0.7	56	4.1	465	140	830
203	182	264	50	42	1	24	1.8	37	60	150
203	260	264	50	85	1	17	1.2	13	40	75
255	105	432	33	10	1	53	6.4	397	110	600
255	180	432	50	31	1	31	3.7	79	60	210
255	300	432	50	85	1	19	2.3	17	40	75

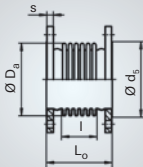
1) Inner sleeve, movement absorption: The inner sleeve is designed for axial movement only.

The movements (axial, angular, lateral) apply to 1000 load changes and are to be regarded as alternativ, i.e. the sum of their proportions in percentages should not exceed 100 %.

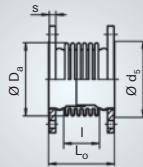
2) Available with other hole patterns / thicknesses on request. The overall length L0 may change then.

# AXIAL EXPANSION JOINTS FOR LOW PRESSURE WITH LOOSE FLANGES

Type ABN  
without inner  
sleeve



Type ABN  
with inner  
sleeve



06

Nominal diameter	Nominal axial movement absorption <sup>1)</sup>	Type ABN 01...	Order No. standard version		Overall length	Weight approx.		Flange <sup>2</sup>		
			without inner sleeve	with inner sleeve		without inner sleeve	with inner sleeve	drilling template as per EN 1092	rim diameter	thickness
DN	2δN	-	-	-	L <sub>o</sub>	G	G	PN	d5	s
-	mm	-	-	-	mm	kg	kg	-	mm	mm
250	72	.0250.072.0	419307	419432	210	20	21	6	312	24
250	132	.0250.132.0	419308	419433	295	21	23	6	312	24
250	204	.0250.204.0	419310	419434	397	22	25	6	312	24
300	56	.0300.056.0	419309	419435	184	26	27	6	365	24
300	140	.0300.140.0	419311	419436	298	27	30	6	365	24
300	210	.0300.210.0	419312	419437	393	29	32	6	365	24
350	60	.0350.060.0	419313	419449	192	36	37	6	410	26
350	120	.0350.120.0	419314	419450	272	37	40	6	410	26
350	210	.0350.210.0	419315	419451	392	39	43	6	410	26
400	65	.0400.065.0	419316	419452	232	45	47	6	465	28
400	104	.0400.104.0	419318	419453	295	47	50	6	465	28
400	195	.0400.195.0	419319	419463	442	52	57	6	465	28
450	56	.0450.056.0	419320	419464	219	55	57	6	520	30
450	112	.0450.112.0	419321	419465	307	58	62	6	520	30
450	196	.0450.196.0	419322	419466	439	63	69	6	520	30
500	68	.0500.068.0	419323	419467	223	59	62	6	570	30
500	119	.0500.119.0	419324	419468	292	62	66	6	570	30
500	221	.0500.221.0	419325	419469	430	68	74	6	570	30
600	76	.0600.076.0	419326	419470	239	78	81	6	670	32
600	133	.0600.133.0	419327	419471	317	82	87	6	670	32
600	228	.0600.228.0	419328	419472	447	88	96	6	670	32

# TYPE ABN 01... PN 1

06

Nominal movement absorption <sup>1)</sup>			Nominal movement absorption <sup>1)</sup>		Vibrations in all planes	Spring rate			Natural frequency of bellows	
outside diameter	corrugated length	effective cross-section	angular	lateral		axial	angular	lateral	axial	radial
Da	l	A	2cαN	2λ.N	â	cδ	cα	cλ	ωa	ωr
mm	mm	cm <sup>2</sup>	degree	mm	mm	N/mm	Nm/deg	N/mm	Hz	Hz
312	102	661	28	8.4	0.7	62	11	752	110	780
312	187	661	47	28	1	34	6.2	123	60	230
312	289	661	50	68	1	22	4	33	40	100
365	76	916	18	4.2	0.4	91	23	2756	140	1610
365	190	916	43	26	1	36	9.2	174	60	260
365	285	916	50	58	1	24	6.1	52	40	115
400	80	1104	18	4.3	0.4	82	25	2703	120	1490
400	160	1104	34	17	1	41	13	338	65	375
400	280	1104	50	52	1	23	7.4	62	35	120
458	105	1445	17	5.3	0.5	211	85	5283	120	1260
458	168	1445	27	14	1	132	53	1291	80	500
458	315	1445	45	48	1	70	29	195	40	140
513	88	1825	13	3.4	0.3	243	123	10935	130	1850
513	176	1825	32	17	1	121	62	1361	70	460
513	308	1825	41	42	1	69	35	253	40	150
569	92	2252	14	3.9	0.3	214	135	10875	115	1690
569	161	2252	24	12	1	122	77	2025	70	550
569	299	2252	42	41	1	66	41	318	35	160
674	104	3202	14	4.1	0.3	214	191	12099	100	1570
674	182	3202	23	13	1	122	109	2252	60	510
674	312	3202	36	37	1	71	64	446	35	175

1) Inner sleeve, movement absorption: The inner sleeve is designed for axial movement only.

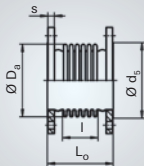
The movements (axial, angular, lateral) apply to 1000 load changes and are to be regarded as alternativ, i.e. the sum of their proportions in percentages should not exceed 100 %.

2) Available with other hole patterns / thicknesses on request. The overall length L0 may change then.

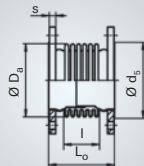


# AXIAL EXPANSION JOINTS FOR LOW PRESSURE WITH LOOSE FLANGES

Type ABN  
without inner  
sleeve



Type ABN  
with inner  
sleeve



Nominal diameter	Nominal axial movement absorption <sup>1)</sup>	Type ABN 01...	Order No. standard version		Overall length	Weight approx.		Flange <sup>2)</sup>		
			without inner sleeve	with inner sleeve		without inner sleeve	with inner sleeve	drilling template as per EN 1092	rim diameter	thickness
DN	2Δ <sub>N</sub>	-	-	-	L <sub>o</sub>	G	G	PN	d <sub>s</sub>	s
-	mm	-	-	-	mm	kg	kg	-	mm	mm
700	80	.0700.080.0	419329	419473	218	63	68	6	775	20
700	120	.0700.120.0	419330	419474	274	66	72	6	775	20
700	220	.0700.220.0	419331	419475	414	74	83	6	775	20
800	84	.0800.084.0	419332	419476	230	78	83	6	880	20
800	126	.0800.126.0	419333	419477	288	81	88	6	880	20
800	231	.0800.231.0	419334	419478	433	90	101	6	880	20
900	84	.0900.084.0	419335	419479	234	82	88	6	980	20
900	126	.0900.126.0	419336	419481	294	87	95	6	980	20
900	210	.0900.210.0	419337	419482	414	95	107	6	980	20
1000	72	.1000.072.0	419338	419483	220	87	93	6	1080	20
1000	144	.1000.144.0	419339	419484	316	94	104	6	1080	20
1000	240	.1000.240.0	419340	419485	444	104	118	6	1080	20
1200	72	.1200.072.0	419341	419486	225	108	123	2	1280	20
1200	120	.1200.120.0	419342	419487	287	114	134	2	1280	20
1200	216	.1200.216.0	419343	419488	411	126	156	2	1280	20
1400	48	.1400.048.0	419344	419490	136	125	138	2	1466	20
1400	108	.1400.108.0	419345	419491	266	137	162	2	1466	20
1400	180	.1400.180.0	419346	419492	422	151	191	2	1466	20
1600	48	.1600.048.0	419347	419493	136	155	170	2	1666	20
1600	108	.1600.108.0	419385	419494	266	169	198	2	1666	20
1600	180	.1600.180.0	419386	419495	422	185	231	2	1666	20

# TYPE ABN 01... PN 1

06

Bellows			Nominal movement absorption <sup>1)</sup>		Vibrations in all planes	Spring rate			Natural frequency of bellows	
outside diameter	corrugated length	effective cross-section	angular	lateral		axial	angular	lateral	axial	radial
$D_o$	$l$	$A$	$2\alpha_N$	$2\lambda_N$	$\hat{a}$	$c_o$	$c_a$	$c_r$	$\omega_a$	$\omega_r$
mm	mm	cm <sup>2</sup>	degree	mm	mm	N/mm	Nm/deg	N/mm	Hz	Hz
780	112	4324	12	4	0.3	203	244	13365	90	1480
780	168	4324	18	9.1	0.8	135	162	3950	60	660
780	308	4324	30	30	1	74	89	644	30	195
882	116	5588	11	3.9	0.3	220	341	17449	85	1570
882	174	5588	16	8.7	0.8	147	228	5182	60	700
882	319	5588	28	29	1	80	124	839	30	210
992	120	7133	9.9	3.5	0.2	237	472	22421	80	1650
992	180	7133	15	7.9	0.7	158	313	6643	60	730
992	300	7133	23	22	1	95	188	1438	30	260
1095	96	8750	7.7	2.2	0.2	335	814	60745	105	2940
1095	192	8750	15	8.7	0.7	167	408	7570	50	740
1095	320	8750	23	24	1	100	245	1632	30	265
1295	93	12331	6.5	1.8	0.1	330	1134	89855	95	3210
1295	155	12331	11	4.9	0.4	198	678	19409	60	1160
1295	279	12331	18	16	1	110	377	3328	30	360
1456	104	16016	3.8	1.2	0.1	911	4053	257632	150	5320
1456	234	16016	8.4	5.9	0.5	405	1802	22624	70	1050
1456	390	16016	13	16	1	243	1081	4887	40	380
1656	104	20816	3.4	1	0.1	1035	5990	380429	150	6040
1656	234	20816	7.4	5.2	0.5	460	2660	33398	70	1200
1656	390	20816	12	14	1	276	1596	7214	40	430

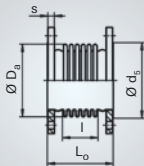
1) Inner sleeve, movement absorption: The inner sleeve is designed for axial movement only.

The movements (axial, angular, lateral) apply to 1000 load changes and are to be regarded as alternativ, i.e. the sum of their proportions in percentages should not exceed 100 %.

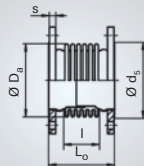
2) Available with other hole patterns / thicknesses on request. The overall length L0 may change then.

# AXIAL EXPANSION JOINTS FOR LOW PRESSURE WITH LOOSE FLANGES

Type ABN  
without inner  
sleeve



Type ABN  
with inner  
sleeve



Nominal diameter	Nominal axial movement absorption <sup>1)</sup>	Type ABN 01...	Order No. standard version		Overall length	Weight approx.		Flange <sup>2</sup>		
			without inner sleeve	with inner sleeve		without inner sleeve	with inner sleeve	drilling template as per EN 1092	rim diameter	thickness
DN	2δ <sub>N</sub>	-	-	-	L <sub>o</sub>	G	G	PN	d <sub>s</sub>	s
-	mm	-	-	-	mm	kg	kg	-	mm	mm
1800	48	.1800.048.0	419387	419496	136	174	190	2	1866	20
1800	108	.1800.108.0	419388	419498	266	189	222	2	1866	20
1800	180	.1800.180.0	419389	419499	422	208	259	2	1866	20
2000	48	.2000.048.0	419390	419500	136	192	210	2	2066	20
2000	108	.2000.108.0	419391	419501	266	209	245	2	2066	20
2000	180	.2000.180.0	419392	419502	422	230	286	2	2066	20
2200	48	.2200.048.0	419393	419503	136	226	246	2	2266	20
2200	108	.2200.108.0	419394	419505	266	245	285	2	2266	20
2200	180	.2200.180.0	419396	419506	422	267	332	2	2266	20
2400	48	.2400.048.0	419397	419507	136	246	268	2	2466	20
2400	108	.2400.108.0	419398	419508	266	266	310	2	2466	20
2400	180	.2400.180.0	419399	419509	422	291	361	2	2466	20
2600	48	.2600.048.0	419400	419510	136	265	290	2	2666	20
2600	108	.2600.108.0	419401	419511	266	288	335	2	2666	20
2600	180	.2600.180.0	419402	419513	422	315	391	2	2666	20
2800	48	.2800.048.0	419403	419514	136	319	345	2	2866	20
2800	108	.2800.108.0	419404	419516	266	343	395	2	2866	20
2800	180	.2800.180.0	419405	419518	422	372	454	2	2866	20
3000	48	.3000.048.0	419406	419519	136	341	369	2	3066	20
3000	108	.3000.108.0	419407	419520	266	367	422	2	3066	20
3000	180	.3000.180.0	419408	419521	422	398	486	2	3066	20

# TYPE ABN 01... PN 1

06

Bellows			Nominal movement absorption <sup>1)</sup>		Vibrations in all planes	Spring rate			Natural frequency of bellows	
outside diameter	corrugated length	effective cross-section	angular	lateral		axial	angular	lateral	axial	radial
D <sub>e</sub>	l	A	2α <sub>N</sub>	2λ <sub>N</sub>	â	c <sub>0</sub>	c <sub>α</sub>	c <sub>λ</sub>	ω <sub>a</sub>	ω <sub>r</sub>
mm	mm	cm <sup>2</sup>	degree	mm	mm	N/mm	Nm/deg	N/mm	Hz	Hz
1856	104	26245	3	0.9		1158	8449	536643	150	6760
1856	234	26245	6.6	4.6	0.4	515	3754	47143	70	1340
1856	390	26245	11	13	1	309	2253	10183	40	480
2056	104	32302	2.7	0.8		1281	11503	730650	150	7480
2056	234	32302	6	4.2	0.4	569	5114	64107	70	1480
2056	390	32302	9.6	12	1	342	3069	13872	40	530
2256	104	38987	2.5	0.7		1403	15205	965857	150	8200
2256	234	38987	5.4	3.8	0.3	623	6758	84718	70	1620
2256	390	38987	8.8	11	1	374	4050	18309	40	580
2456	104	46301	2.3	0.7		1524	19613	1245968	150	8900
2456	234	46301	5	3.5	0.3	677	8720	109332	70	1760
2456	390	46301	8.1	9.6	1	406	5235	23604	40	630
2656	104	54243	2.1	0.6		1646	24816	1576541	150	9620
2656	234	54243	4.6	3.2	0.3	731	11029	138302	70	1900
2656	390	54243	7.5	8.9	0.8	439	6615	29900	40	680
2856	104	62813	1.9	0.6		1767	30848	1959837	150	10330
2856	234	62813	4.3	3	0.2	785	13714	171984	65	2040
2856	390	62813	7	8.3	0.8	471	8218	37149	40	740
3056	104	72011	1.8	0.5		1888	37786	2400702	150	11050
3056	234	72011	4	2.8	0.2	839	16803	210733	65	2180
3056	390	72011	6.5	7.7	0.7	504	10082	45573	40	790

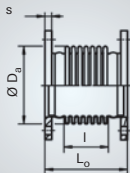
1) Inner sleeve, movement absorption: The inner sleeve is designed for axial movement only.

The movements (axial, angular, lateral) apply to 1000 load changes and are to be regarded as alternativ, i.e. the sum of their proportions in percentages should not exceed 100 %.

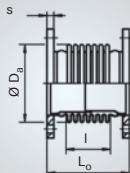
2) Available with other hole patterns / thicknesses on request. The overall length L0 may change then.

# AXIAL EXPANSION JOINTS FOR LOW PRESSURE WITH PLAIN FIXED FLANGES

Type AFN  
without inner  
sleeve



Type AFN  
with inner  
sleeve



Nominal diameter	Nominal axial movement absorption <sup>1)</sup>	Type AFN 01...	Order No. standard version		Overall length	Weight approx.		Flange <sup>2)</sup>	
			without inner sleeve	with inner sleeve		without inner sleeve	with inner sleeve	drilling template as per EN 1092	thickness
DN	$2\delta_N$	-	-	-	$L_o$	G	G	PN	s
-	mm	-	-	-	mm	kg	kg	-	mm
50	20	.0050.020.0	420180	420272	129	3.2	3.4	6	16
50	56	.0050.056.0	420181	420273	210	3.5	3.9	6	16
50	80	.0050.080.0	420182	421598	264	3.6	4	6	16
65	23	.0065.023.0	420183	421599	129	4.1	4.3	6	16
65	64	.0065.064.0	420184	421600	210	4.4	4.8	6	16
65	92	.0065.092.0	420185	421601	264	4.7	5	6	16
80	37	.0080.037.0	420186	421602	156	6	7	6	18
80	69	.0080.069.0	420187	421603	216	7	7	6	18
80	101	.0080.101.0	420188	421604	276	7	8	6	18
100	40	.0100.040.0	420189	421605	152	7	8	6	18
100	79	.0100.079.0	420190	421606	218	8	8	6	18
100	112	.0100.112.0	420191	421607	273	8	9	6	18
125	63	.0125.063.0	420192	421608	189	9	10	6	20
125	117	.0125.117.0	420193	421609	267	10	11	6	20
125	180	.0125.180.0	420194	421610	358	11	12	6	20
150	54	.0150.054.0	420195	421611	176	11	11	6	20
150	126	.0150.126.0	420196	421612	280	11	13	6	20
150	180	.0150.180.0	420197	421613	358	12	14	6	20
200	70	.0200.070.0	420198	421614	205	15	16	6	22
200	120	.0200.120.0	420199	421615	280	16	18	6	22
200	200	.0200.200.0	420200	421617	400	17	20	6	22

# TYPE AFN 01... PN 1

06

Bellows			Nominal movement absorption <sup>1)</sup>		Vibrations in all planes	Spring rate			Natural frequency of bellows	
outside diameter	corrugated length	effective cross-section	angular	lateral		axial	angular	lateral	axial	radial
D <sub>s</sub>	l	A	2α <sub>N</sub>	2λ <sub>N</sub>	â	c <sub>s</sub>	c <sub>α</sub>	c <sub>λ</sub>	ω <sub>a</sub>	ω <sub>r</sub>
mm	mm	cm <sup>2</sup>	degree	mm	mm	N/mm	Nm/deg	N/mm	Hz	Hz
89	45	46	30	3.9	0.3	104	1.3	451	420	1800
89	126	46	50	31	1	37	0.5	20	150	230
89	180	46	50	63	1	26	0.3	7	105	110
107	45	68.7	28	3.7	0.3	101	1.9	654	350	1840
107	126	68.7	50	29	1	36	0.7	30	125	235
107	180	68.7	50	59	1	25	0.5	10	90	115
121	70	89.1	39	8.1	0.5	67	1.7	233	220	840
121	130	89.1	50	28	1	36	0.9	36	165	340
121	190	89.1	50	60	1	25	0.6	12	80	115
148	66	137	34	6.6	0.5	72	2.8	432	210	1050
148	132	137	50	26	1	36	1.4	54	90	220
148	187	137	50	53	1	26	1	19	60	110
174	91	187	44	12	0.5	41	2.1	177	120	520
174	169	187	50	43	1	22	1.1	28	70	150
174	260	187	50	101	1	14	0.7	7.4	40	65
203	78	264	32	7.7	0.7	56	4.1	465	140	830
203	182	264	50	42	1	24	1.8	37	60	150
203	260	264	50	85	1	17	1.2	13	40	75
255	105	432	33	10	1	53	6.4	397	110	600
255	180	432	50	31	1	31	3.7	79	60	210
255	300	432	50	85	1	19	2.3	17	40	75

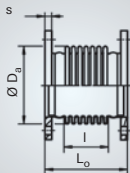
1) Inner sleeve, movement absorption: The inner sleeve is designed for axial movement only.

The movements (axial, angular, lateral) apply to 1000 load changes and are to be regarded as alternativ, i.e. the sum of their proportions in percentages should not exceed 100 %.

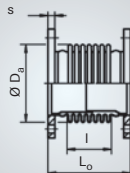
2) Available with other hole patterns / thicknesses on request. The overall length L0 may change then.

# AXIAL EXPANSION JOINTS FOR LOW PRESSURE WITH PLAIN FIXED FLANGES

Type AFN  
without inner  
sleeve



Type AFN  
with inner  
sleeve



Nominal diameter	Nominal axial movement absorption <sup>1)</sup>	Type AFN 01...	Order No. standard version		Overall length	Weight approx.		Flange <sup>2)</sup>	
			without inner sleeve	with inner sleeve		without inner sleeve	with inner sleeve	drilling template as per EN 1092	thickness
DN	2δ <sub>N</sub>	-	-	-	L <sub>o</sub>	G	G	PN	s
-	mm	-	-	-	mm	kg	kg	-	mm
250	72	.0250.072.0	420201	421618	214	20	21	6	24
250	132	.0250.132.0	420202	421619	299	21	23	6	24
250	204	.0250.204.0	420203	421620	401	22	25	6	24
300	56	.0300.056.0	420204	421621	188	25	28	6	24
300	140	.0300.140.0	420205	421622	302	27	31	6	24
300	210	.0300.210.0	420206	421623	397	28	34	6	24
350	60	.0350.060.0	420207	421624	194	35	38	6	26
350	120	.0350.120.0	420208	421625	274	37	41	6	26
350	210	.0350.210.0	420209	421626	394	39	45	6	26
400	65	.0400.065.0	420210	421627	230	44	48	6	28
400	104	.0400.104.0	420211	421628	293	46	51	6	28
400	195	.0400.195.0	420212	421629	440	51	59	6	28
450	56	.0450.056.0	420213	421630	217	54	58	6	30
450	112	.0450.112.0	420214	421631	305	57	63	6	30
450	196	.0450.196.0	420215	421632	437	62	71	6	30
500	68	.0500.068.0	420216	421633	221	58	63	6	30
500	119	.0500.119.0	420217	421634	290	61	67	6	30
500	221	.0500.221.0	420218	421635	428	67	77	6	30
600	76	.0600.076.0	420219	421636	237	76	82	6	32
600	133	.0600.133.0	420220	421637	315	80	88	6	32
600	228	.0600.228.0	420223	421638	445	87	98	6	32

# TYPE AFN 01... PN 1

06

Bellows			Nominal movement absorption <sup>1)</sup>		Vibrations in all planes	Spring rate			Natural frequency of bellows	
outside diameter	corrugated length	effective cross-section	angular	lateral		axial	angular	lateral	axial	radial
D <sub>s</sub>	l	A	2α <sub>N</sub>	2λ <sub>N</sub>	â	c <sub>s</sub>	c <sub>α</sub>	c <sub>λ</sub>	ω <sub>a</sub>	ω <sub>r</sub>
mm	mm	cm <sup>2</sup>	degree	mm	mm	N/mm	Nm/deg	N/mm	Hz	Hz
312	102	661	27	8.4	0.7	62	11	752	110	780
312	187	661	45	28	1	34	6.2	123	60	230
312	289	661	50	68	1	22	4	33	40	100
365	76	916	18	4.2	0.4	91	23	2756	140	1610
365	190	916	41	26	1	36	9.2	174	60	260
365	285	916	50	58	1	24	6.1	52	40	115
400	80	1104	18	4.3	0.4	82	25	2703	120	1490
400	160	1104	33	17	1	41	13	338	65	375
400	280	1104	46	52	1	23	7.4	62	35	120
458	105	1445	17	5.3	0.5	211	85	5283	120	1260
458	168	1445	27	14	1	132	53	1291	80	500
458	315	1445	46	48	1	70	29	195	40	140
513	88	1825	13	3.4	0.3	243	123	10935	130	1850
513	176	1825	26	14	1	121	62	1361	70	460
513	308	1825	41	42	1	69	35	253	40	150
569	92	2252	14	3.9	0.3	214	135	10875	115	1690
569	161	2252	24	12	1	122	77	2025	70	550
569	299	2252	42	41	1	66	41	318	35	160
674	104	3202	14	4.1	0.3	214	191	12099	100	1570
674	182	3202	23	13	1	122	109	2252	60	510
674	312	3202	36	37	1	71	64	446	35	175

1) Inner sleeve, movement absorption: The inner sleeve is designed for axial movement only.

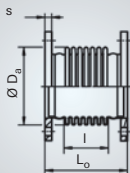
The movements (axial, angular, lateral) apply to 1000 load changes and are to be regarded as alternativ, i.e. the sum of their proportions in percentages should not exceed 100 %.

2) Available with other hole patterns / thicknesses on request. The overall length L0 may change then.

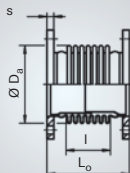


# AXIAL EXPANSION JOINTS FOR LOW PRESSURE WITH PLAIN FIXED FLANGES

Type AFN  
without inner  
sleeve



Type AFN  
with inner  
sleeve



Nominal diameter	Nominal axial movement absorption <sup>1)</sup>	Type AFN 01...	Order No. standard version		Overall length	Weight approx.		Flange <sup>2</sup>	
			without inner sleeve	with inner sleeve		without inner sleeve	with inner sleeve	drilling template as per EN 1092	thickness
DN	$2\delta_N$	-	-	-	$L_o$	G	G	PN	s
-	mm	-	-	-	mm	kg	kg	-	mm
700	80	.0700.080.0	420225	421639	230	62	69	6	20
700	120	.0700.120.0	420227	421640	286	65	74	6	20
700	220	.0700.220.0	420228	421641	426	73	87	6	20
800	84	.0800.084.0	420229	421642	244	76	85	6	20
800	126	.0800.126.0	420230	421643	302	79	90	6	20
800	231	.0800.231.0	420231	421644	447	89	105	6	20
900	84	.0900.084.0	420232	421645	248	80	91	6	20
900	126	.0900.126.0	420233	421646	308	85	98	6	20
900	210	.0900.210.0	420234	421647	428	93	112	6	20
1000	72	.1000.072.0	420235	421648	234	85	96	6	20
1000	144	.1000.144.0	420236	421649	330	92	108	6	20
1000	240	.1000.240.0	420237	421650	458	102	124	6	20
1200	72	.1200.072.0	420238	421651	241	105	123	2	20
1200	120	.1200.120.0	420239	421652	303	111	134	2	20
1200	216	.1200.216.0	420240	421653	427	123	156	2	20
1400	48	.1400.048.0	420241	421654	152	122	134	2	20
1400	108	.1400.108.0	420243	421655	282	134	158	2	20
1400	180	.1400.180.0	420244	421656	438	149	186	2	20
1600	48	.1600.048.0	420246	421657	152	152	166	2	20
1600	108	.1600.108.0	420247	421658	282	166	193	2	20
1600	180	.1600.180.0	420248	421659	438	182	225	2	20

# TYPE AFN 01... PN 1

06

Bellows			Nominal movement absorption <sup>1)</sup>		Vibrations in all planes	Spring rate			Natural frequency of bellows	
outside diameter	corrugated length	effective cross-section	angular	lateral		axial	angular	lateral	axial	radial
$D_e$	$l$	$A$	$2\alpha_N$	$2\lambda_N$	$\hat{a}$	$c_a$	$c_a$	$c_r$	$\omega_a$	$\omega_r$
mm	mm	cm <sup>2</sup>	degree	mm	mm	N/mm	Nm/deg	N/mm	Hz	Hz
780	112	4324	12	4	0.3	203	244	13365	90	1480
780	168	4324	18	9.1	0.8	135	162	3950	60	660
780	308	4324	30	30	1	74	89	644	30	195
882	116	5588	11	3.9	0.3	220	341	17449	85	1570
882	174	5588	17	8.7	0.8	147	228	5182	60	700
882	319	5588	28	29	1	80	124	839	30	210
992	120	7133	10	3.5	0.2	237	472	22421	80	1650
992	180	7133	15	7.9	0.7	158	313	6643	60	730
992	300	7133	23	22	1	95	188	1438	30	260
1095	96	8750	7.7	2.2	0.2	335	814	60745	105	2940
1095	192	8750	15	8.7	0.7	167	408	7570	50	740
1095	320	8750	24	24	1	100	245	1632	30	265
1295	93	12331	6.5	1.8	0.1	330	1134	89855	95	3210
1295	155	12331	11	4.9	0.4	198	678	19409	60	1160
1295	279	12331	18	16	1	110	377	3328	30	360
1456	104	16016	3.9	1.2	0.1	911	4053	257632	150	5320
1456	234	16016	8.5	5.9	0.5	405	1802	22624	70	1050
1456	390	16016	14	16	1	243	1081	4887	40	380
1656	104	20816	3.4	1	0.1	1035	5990	380429	150	6040
1656	234	20816	7.5	5.2	0.5	460	2660	33398	70	1200
1656	390	20816	12	14	1	276	1596	7214	40	430

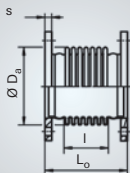
1) Inner sleeve, movement absorption: The inner sleeve is designed for axial movement only.

The movements (axial, angular, lateral) apply to 1000 load changes and are to be regarded as alternativ, i.e. the sum of their proportions in percentages should not exceed 100 %.

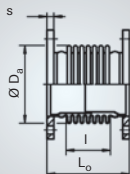
2) Available with other hole patterns / thicknesses on request. The overall length L0 may change then.

# AXIAL EXPANSION JOINTS FOR LOW PRESSURE WITH PLAIN FIXED FLANGES

Type AFN  
without inner  
sleeve



Type AFN  
with inner  
sleeve



Nominal diameter	Nominal axial movement absorption <sup>1)</sup>	Type AFN 01...	Order No. standard version		Overall length	Weight approx.		Flange <sup>2</sup>	
			without inner sleeve	with inner sleeve		without inner sleeve	with inner sleeve	drilling template as per EN 1092	thickness
DN	2δ <sub>N</sub>	-	-	-	L <sub>o</sub>	G	G	PN	s
-	mm	-	-	-	mm	kg	kg	-	mm
1800	48	.1800.048.0	420250	421660	152	170	186	2	20
1800	108	.1800.108.0	420251	421661	282	185	216	2	20
1800	180	.1800.180.0	420252	421662	438	204	252	2	20
2000	48	.2000.048.0	420253	421663	152	188	206	2	20
2000	108	.2000.108.0	420255	421664	282	205	239	2	20
2000	180	.2000.180.0	420256	421665	438	226	279	2	20
2200	48	.2200.048.0	420257	421666	152	221	241	2	20
2200	108	.2200.108.0	420258	421667	282	240	279	2	20
2200	180	.2200.180.0	420259	421668	438	263	323	2	20
2400	48	.2400.048.0	420260	421669	152	241	262	2	20
2400	108	.2400.108.0	420261	421670	282	262	304	2	20
2400	180	.2400.180.0	420262	421671	438	286	351	2	20
2600	48	.2600.048.0	420263	421672	152	260	283	2	20
2600	108	.2600.108.0	420264	421673	282	283	328	2	20
2600	180	.2600.180.0	420265	421674	438	309	380	2	20
2800	48	.2800.048.0	420266	421675	152	313	338	2	20
2800	108	.2800.108.0	420267	421676	282	338	387	2	20
2800	180	.2800.180.0	420268	421677	438	367	443	2	20
3000	48	.3000.048.0	420269	421678	152	335	362	2	20
3000	108	.3000.108.0	420270	421679	282	361	414	2	20
3000	180	.3000.180.0	420271	421680	438	392	474	2	20

# TYPE AFN 01... PN 1

06

Bellows			Nominal movement absorption <sup>1)</sup>		Vibrations in all planes	Spring rate			Natural frequency of bellows	
outside diameter	corrugated length	effective cross-section	angular	lateral		axial	angular	lateral	axial	radial
$D_e$	$l$	$A$	$2\alpha_N$	$2\lambda_N$	$\hat{a}$	$c_o$	$c_u$	$c_r$	$\omega_a$	$\omega_r$
mm	mm	cm <sup>2</sup>	degree	mm	mm	N/mm	Nm/deg	N/mm	Hz	Hz
1856	104	26245	3	0.9	0	1158	8449	536643	150	6760
1856	234	26245	6.7	4.6	0.4	515	3754	47143	70	1340
1856	390	26245	11	13	1	309	2253	10183	40	480
2056	104	32302	2.7	0.8	0	1281	11503	730650	150	7480
2056	234	32302	6	4.2	0.4	569	5114	64107	70	1480
2056	390	32302	9.9	12	1	342	3069	13872	40	530
2256	104	38987	2.5	0.7	0	1403	15205	965857	150	8200
2256	234	38987	5.5	3.8	0.3	623	6758	84718	70	1620
2256	390	38987	9	11	1	374	4050	18309	40	580
2456	104	46301	2.3	0.7	0	1524	19613	1245968	150	8900
2456	234	46301	5	3.5	0.3	677	8720	109332	70	1760
2456	390	46301	8.2	9.6	1	406	5235	23604	40	630
2656	104	54243	2.1	0.6	0	1646	24816	1576541	150	9620
2656	234	54243	4.7	3.2	0.3	731	11029	138302	70	1900
2656	390	54243	7.7	8.9	0.8	439	6615	29900	40	680
2856	104	62813	1.9	0.6	0	1767	30848	1959837	150	10330
2856	234	62813	4.3	3	0.2	785	13714	171984	65	2040
2856	390	62813	7.2	8.3	0.8	471	8218	37149	40	740
3056	104	72011	1.8	0.5	0	1888	37786	2400702	150	11050
3056	234	72011	4	2.8	0.2	839	16803	210733	65	2180
3056	390	72011	6.7	7.7	0.7	504	10082	45573	40	790

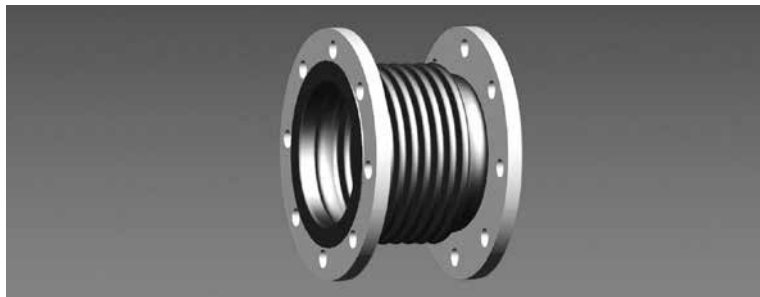
1) Inner sleeve, movement absorption: The inner sleeve is designed for axial movement only.

The movements (axial, angular, lateral) apply to 1000 load changes and are to be regarded as alternativ, i.e. the sum of their proportions in percentages should not exceed 100 %.

2) Available with other hole patterns / thicknesses on request. The overall length L0 may change then.

# AXIAL EXPANSION JOINTS WITH FLANGES TYPE ABN, AFN

06



## Type designation

The type designation consists of 2 parts

1. Type series, defined by 3 letters
2. Nominal size, defined by 10 digits

## Example

Type ABN: HYDRA Axial expansion joint with loose flanges

Type AFN: HYDRA Axial expansion joint with plain fixed flanges

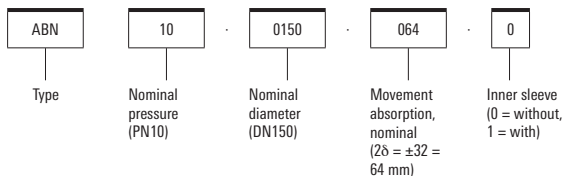
## Standard version/materials

Multi-ply bellows made of 1.4541

Flange made of S235JRG2 (1.0038) or P250GH (1.0460)

Operating temperature: up to 300 °C / 450 °C

## Type designation (example)



## Order text according to guideline 2014/68/EU "Pressure Equipment Directive"

Please state the following with your order:

For standard versions

- Type designation or order number

With material variation

- Type designation
- Details of the materials

According to the Pressure Equipment Directive, the following information is required for testing and documentation:

06

Type of pressure equipment according to Art. 1 & 2:

- Vessel - volume V [l] \_\_\_\_\_
- Piping - nominal diameter DN \_\_\_\_\_

Medium property according to Art. 13:

- Group 1 – dangerous
- Group 2 – all other fluids

State of medium

- Gaseous or liquid if PD > 0.5 bar
- Liquid if PD ≤ 0.5 bar

Design data:

- Max. allowable pressure [bar] \_\_\_\_\_
- Max./min. allowable temperature [°C] \_\_\_\_\_
- Test pressure PT [bar] \_\_\_\_\_

Optional:

- Category \_\_\_\_\_

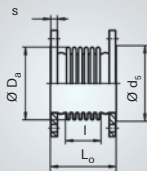
### Note

Tell us the dimensions that deviate from the standard and we customize the expansion joint to your specification.

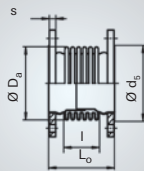
On request, flanges can also be supplied with other hole patterns / flange sheet thicknesses. In this case, the specified overall length L0 may change.

# AXIAL EXPANSION JOINTS WITH LOOSE FLANGES

Type ABN  
without inner  
sleeve



Type ABN  
with inner  
sleeve



Nominal diameter	Nominal axial movement absorption <sup>1)</sup>	Type ABN 02...	Order No. standard version		Overall length	Weight approx.		Flange <sup>2)</sup>		
			without inner sleeve	with inner sleeve		without inner sleeve	with inner sleeve	drilling as per EN 1092	rim diameter	thickness
DN	2 $\delta_N$	–	–	–	L <sub>o</sub>	G	G	PN	d <sub>s</sub>	s
–	mm	–	–	–	mm	kg	kg	–	mm	mm
50	20	.0050.020.0	419538	419635	117	3.3	3.4	6	90	16
50	40	.0050.040.0	419539	419636	162	3.5	3.7	6	90	16
50	70	.0050.070.0	419540	419637	244	4.1	4.5	6	90	16
65	23	.0065.023.0	419541	419638	117	4.3	4.5	6	107	16
65	60	.0065.060.0	419542	419639	189	4.6	5	6	107	16
65	87	.0065.087.0	419543	419640	263	5	6	6	107	16
80	27	.0080.027.0	419545	419641	126	7	7	6	122	18
80	64	.0080.064.0	419546	419642	196	7	7	6	122	18
80	92	.0080.092.0	419547	419643	275	8	8	6	122	18
100	46	.0100.046.0	419548	419644	153	7	8	6	147	18
100	73	.0100.073.0	419549	419645	197	8	8	6	147	18
100	98	.0100.098.0	419550	419646	286	10	11	6	147	18
125	45	.0125.045.0	419551	419647	155	9	10	6	178	20
125	81	.0125.081.0	419552	419648	207	10	10	6	178	20
125	140	.0125.140.0	419553	419649	372	14	15	6	178	20
150	45	.0150.045.0	419554	419650	155	11	11	6	202	20
150	81	.0150.081.0	419555	419651	207	11	12	6	202	20
150	160	.0150.160.0	419556	419652	392	16	18	6	202	20
200	60	.0200.060.0	419557	419653	184	15	16	6	258	22
200	110	.0200.110.0	419558	419654	271	17	19	6	258	22
200	190	.0200.190.0	419559	419655	419	23	25	6	258	22

# TYPE ABN 02...

## PN 2.5

06

Bellows			Nominal movement absorption <sup>1)</sup>		Spring rate		
outside diameter	corrugated length	effective cross-section	angular	lateral	axial	angular	lateral
D <sub>s</sub>	l	A	2c <sub>αN</sub>	2λ <sub>N</sub>	c <sub>0</sub>	c <sub>α</sub>	c <sub>λ</sub>
mm	mm	cm <sup>2</sup>	degree	mm	N/mm	Nm/deg	N/mm
89	45	46	29	3.9	104	1.3	451
89	90	46	50	16	52	0.7	56
89	171	46	50	52	45	0.6	14
107	45	68.7	28	3.7	101	1.9	654
107	117	68.7	50	25	39	0.7	37
108	190	69.4	50	59	39	0.8	14
121	50	89.1	28	4.1	94	2.3	640
121	120	89.1	50	24	39	1	46
121	198	89.1	50	57	42	1	18
148	77	137	38	9	62	2.4	273
148	121	137	50	22	40	1.5	71
150	208	139	50	51	70	2.7	43
174	65	187	32	6.3	58	3	492
174	117	187	50	20	32	1.7	84
172	280	185	50	85	52	2.7	23
203	65	264	27	5.3	67	4.9	801
203	117	264	46	17	37	2.7	137
203	300	264	50	87	51	3.7	29
255	90	432	28	7.7	62	7.4	631
256	176	434	47	27	50	6	134
257	323	436	50	87	51	6.2	41

1) Inner sleeve, movement absorption: The inner sleeve is designed for axial movement only.

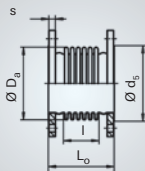
The movements (axial, angular, lateral) apply to 1000 load changes and are to be regarded as alternativ, i.e. the sum of their proportions in percentages should not exceed 100 %.

2) Available with other hole patterns / thicknesses on request. The overall length L0 may change then.

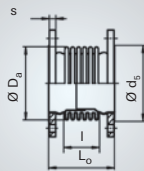


# AXIAL EXPANSION JOINTS WITH LOOSE FLANGES

Type ABN  
without inner  
sleeve



Type ABN  
with inner  
sleeve



Nominal diameter	Nominal axial movement absorption <sup>1)</sup>	Type ABN 02...	Order No. standard version		Overall length	Weight approx.		Flange <sup>2)</sup>		
			without inner sleeve	with inner sleeve		without inner sleeve	with inner sleeve	drilling as per EN 1092	rim diameter	thickness
DN	2 $\delta_N$	-	-	-	L <sub>0</sub>	G	G	PN	d <sub>s</sub>	s
-	mm	-	-	-	mm	kg	kg	-	mm	mm
250	72	.0250.072.0	419560	419656	210	20	21	6	312	24
250	120	.0250.120.0	419561	419659	279	22	24	6	312	24
250	204	.0250.204.0	419562	419660	416	29	32	6	312	24
300	56	.0300.056.0	419563	419661	184	26	27	6	365	24
300	126	.0300.126.0	419564	419662	279	27	29	6	365	24
300	210	.0300.210.0	419565	419663	390	36	40	6	365	24
350	60	.0350.060.0	419566	419665	192	36	38	6	410	26
350	120	.0350.120.0	419567	419666	273	39	41	6	410	26
350	210	.0350.210.0	419568	419667	408	47	51	6	410	26
400	65	.0400.065.0	419569	419668	232	45	48	6	465	28
400	104	.0400.104.0	419570	419669	295	47	50	6	465	28
400	182	.0400.182.0	419571	419670	421	51	56	6	465	28
450	56	.0450.056.0	419572	419672	219	55	57	6	520	30
450	112	.0450.112.0	419573	419673	307	58	61	6	520	30
450	182	.0450.182.0	419574	419674	417	62	68	6	520	30
500	68	.0500.068.0	419575	419675	223	59	62	6	570	30
500	119	.0500.119.0	419576	419677	292	62	66	6	570	30
500	204	.0500.204.0	419577	419678	407	67	73	6	570	30
600	76	.0600.076.0	419578	419680	239	78	82	6	670	32
600	114	.0600.114.0	419579	419682	291	80	84	6	670	32
600	209	.0600.209.0	419580	419683	421	87	94	6	670	32

# TYPE ABN 02...

## PN 2.5

06

Bellows			Nominal movement absorption <sup>1)</sup>		Spring rate		
outside diameter	corrugated length	effective cross-section	angular	lateral	axial	angular	lateral
D <sub>s</sub>	l	A	2α <sub>N</sub>	2λ <sub>N</sub>	c <sub>0</sub>	c <sub>α</sub>	c <sub>λ</sub>
mm	mm	cm <sup>2</sup>	degree	mm	N/mm	Nm/deg	N/mm
312	102	661	27	8.4	62	11	752
315	170	667	42	23	48	8.9	212
316	306	670	50	71	49	9.1	67
365	76	916	18	4.2	91	23	2756
365	171	916	36	21	40	10	239
371	280	932	50	57	52	13	118
400	80	1104	18	4.3	82	25	2703
402	160	1110	33	17	58	18	480
402	294	1110	50	55	60	19	147
458	105	1445	17	5.3	211	85	5283
458	168	1445	26	14	132	53	1291
458	294	1445	38	42	75	30	240
513	88	1825	13	3.4	243	123	10935
513	176	1825	31	17	121	61	1361
513	286	1825	37	39	75	38	320
569	92	2252	14	3.9	214	134	10875
569	161	2252	24	12	122	76	2025
569	276	2252	35	35	71	44	401
674	104	3202	13	4.1	214	190	12099
674	156	3202	19	9.3	143	127	3593
674	286	3202	30	31	78	69	583

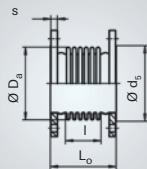
1) Inner sleeve, movement absorption: The inner sleeve is designed for axial movement only.

The movements (axial, angular, lateral) apply to 1000 load changes and are to be regarded as alternativ, i.e. the sum of their proportions in percentages should not exceed 100 %.

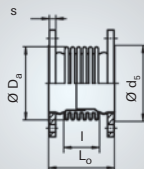
2) Available with other hole patterns / thicknesses on request. The overall length L0 may change then.

# AXIAL EXPANSION JOINTS WITH LOOSE FLANGES

Type ABN  
without inner  
sleeve



Type ABN  
with inner  
sleeve



06

Nominal diameter	Nominal axial movement absorption <sup>1)</sup>	Type ABN 02...	Order No. standard version		Overall length	Weight approx.		Flange <sup>2)</sup>		
			without inner sleeve	with inner sleeve		without inner sleeve	with inner sleeve	drilling as per EN 1092	rim diameter	thickness
DN	2 $\delta_N$	-	-	-	L <sub>o</sub>	G	G	PN	d <sub>s</sub>	s
-	mm	-	-	-	mm	kg	kg	-	mm	mm
700	80	.0700.080.0	419581	419684	242	94	100	6	775	32
700	120	.0700.120.0	419582	419685	298	97	104	6	775	32
700	220	.0700.220.0	419583	419686	438	105	116	6	775	32
800	63	.0800.063.0	419584	419688	229	121	126	6	880	34
800	126	.0800.126.0	419585	419689	316	126	134	6	880	34
800	210	.0800.210.0	419586	419690	432	134	146	6	880	34
900	63	.0900.063.0	419587	419692	234	130	137	6	980	35
900	126	.0900.126.0	419588	419693	324	137	146	6	980	35
900	210	.0900.210.0	419589	419695	444	146	160	6	980	35
1000	72	.1000.072.0	419590	419697	254	149	156	6	1080	37
1000	120	.1000.120.0	419591	419698	318	154	164	6	1080	37
1000	240	.1000.240.0	419592	419699	478	166	183	6	1080	37
1200	72	.1200.072.0	419593	419700	269	204	223	2	1280	40
1200	120	.1200.120.0	419594	419701	333	213	237	2	1280	40
1200	216	.1200.216.0	419595	419703	461	231	270	2	1280	40

# TYPE ABN 02...

## PN 2.5

06

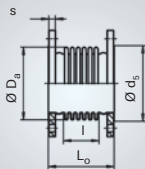
Bellows			Nominal movement absorption <sup>1)</sup>		Spring rate		
outside diameter	corrugated length	effective cross-section	angular	lateral	axial	angular	lateral
D <sub>s</sub>	l	A	2c <sub>αN</sub>	2λ <sub>Nl</sub>	c <sub>0</sub>	c <sub>α</sub>	c <sub>λ</sub>
mm	mm	cm <sup>2</sup>	degree	mm	N/mm	Nm/deg	N/mm
780	112	4324	12	4	203	244	13365
780	168	4324	17	9.1	135	162	3950
780	308	4324	27	30	74	89	644
882	87	5588	8.4	2.2	293	455	41313
882	174	5588	16	8.7	147	228	5182
882	290	5588	23	24	88	137	1117
992	90	7133	7.4	2	316	626	53147
992	180	7133	14	7.9	158	313	6643
992	300	7133	21	22	95	188	1438
1095	96	8750	7.7	2.2	335	814	60745
1095	160	8750	12	6.1	201	489	13121
1095	320	8750	21	24	100	243	1632
1295	96	12331	6.5	1.8	511	1750	130579
1295	160	12331	11	5.1	306	1048	28150
1295	288	12331	18	17	170	582	4827

1) Inner sleeve, movement absorption: The inner sleeve is designed for axial movement only. The movements (axial, angular, lateral) apply to 1000 load changes and are to be regarded as alternativ, i.e. the sum of their proportions in percentages should not exceed 100 %.

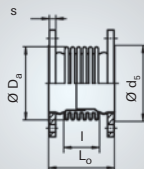
2) Available with other hole patterns / thicknesses on request. The overall length L0 may change then.

# AXIAL EXPANSION JOINTS WITH LOOSE FLANGES

Type ABN  
without inner  
sleeve



Type ABN  
with inner  
sleeve



06

Nominal diameter	Nominal axial movement absorption <sup>1)</sup>	Type ABN 06...	Order No. standard version		Overall length	Weight approx.		Flange <sup>2)</sup>		
			without inner sleeve	with inner sleeve		without inner sleeve	with inner sleeve	drilling as per EN 1092	rim diameter	thickness
DN	2 <sup>Δ</sup> <sub>N</sub>	–	–	–	L <sub>o</sub>	G	G	PN	d <sub>s</sub>	s
–	mm	–	–	–	mm	kg	kg	–	mm	mm
50	20	.0050.020.0	419706	419767	117	3.3	3.4	6	90	16
50	52	.0050.052.0	419707	419769	199	3.9	4.2	6	90	16
65	23	.0065.023.0	419708	419770	117	4.3	4.5	6	107	16
65	41	.0065.041.0	419710	419771	153	4.4	4.6	6	107	16
65	72	.0065.072.0	419711	419772	273	7	7	6	107	16
80	27	.0080.027.0	419712	419773	126	7	7	6	122	18
80	42	.0080.042.0	419713	419774	156	7	7	6	122	18
80	77	.0080.077.0	419714	419775	283	9	10	6	122	18
100	33	.0100.033.0	419715	419776	131	7	8	6	147	18
100	59	.0100.059.0	419716	419777	185	8	9	6	147	18
100	87	.0100.087.0	419717	419778	274	11	12	6	147	18
125	36	.0125.036.0	419718	419779	142	9	10	6	178	20
125	63	.0125.063.0	419719	419780	181	10	10	6	178	20
125	98	.0125.098.0	419720	419781	303	13	14	6	178	20
150	40	.0150.040.0	419721	419782	161	11	11	6	202	20
150	72	.0150.072.0	419722	419783	227	13	14	6	202	20
150	124	.0150.124.0	419723	419784	366	19	21	6	202	20
200	40	.0200.040.0	419724	419785	159	15	16	6	258	22
200	80	.0200.080.0	419725	419786	232	18	20	6	258	22
200	140	.0200.140.0	419726	419787	350	25	27	6	258	22

# TYPE ABN 06... PN 6

06

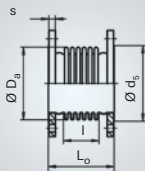
Bellows			Nominal movement absorption <sup>1)</sup>		Spring rate		
outside diameter	corrugated length	effective cross-section	angular	lateral	axial	angular	lateral
D <sub>s</sub>	l	A	2c <sub>αN</sub>	2λ <sub>N</sub>	c <sub>0</sub>	c <sub>α</sub>	c <sub>λ</sub>
mm	mm	cm <sup>2</sup>	degree	mm	N/mm	Nm/deg	N/mm
89	45	46	28	3.9	104	1.3	451
89	126	46	50	28	61	0.8	34
107	45	68.7	27	3.7	101	1.9	654
107	81	68.7	42	12	56	1.1	112
110	198	70.9	50	50	88	1.7	30
121	50	89.1	27	4.1	94	2.3	640
121	80	89.1	38	11	58	1.4	154
123	204	90.8	50	48	95	2.4	40
148	55	137	27	4.6	87	3.3	752
149	108	138	43	16	71	2.7	160
151	195	140	50	42	89	3.5	63
174	52	187	25	4	72	3.7	953
174	91	187	39	12	41	2.1	177
173	210	186	50	45	88	4.6	71
202	70	263	23	5.1	116	8.5	1189
203	135	264	39	18	113	8.3	313
205	272	267	50	61	102	7.6	70
256	64	434	19	3.6	138	17	2791
257	136	436	34	15	120	15	540
260	252	441	50	50	109	13	145

1) Inner sleeve, movement absorption: The inner sleeve is designed for axial movement only. The movements (axial, angular, lateral) apply to 1000 load changes and are to be regarded as alternativ, i.e. the sum of their proportions in percentages should not exceed 100 %.

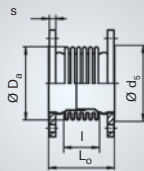
2) Available with other hole patterns / thicknesses on request. The overall length L0 may change then.

# AXIAL EXPANSION JOINTS WITH LOOSE FLANGES

Type ABN  
without inner  
sleeve



Type ABN  
with inner  
sleeve



Nominal diameter	Nominal axial movement absorption <sup>1)</sup>	Type ABN 06...	Order No. standard version		Overall length	Weight approx.		Flange <sup>2)</sup>		
			without inner sleeve	with inner sleeve		without inner sleeve	with inner sleeve	drilling as per EN 1092	rim diameter	thickness
DN	2 <sup>Δ</sup> N	–	–	–	L <sub>o</sub>	G	G	PN	d <sub>s</sub>	s
–	mm	–	–	–	mm	kg	kg	–	mm	mm
250	48	.0250.048.0	419727	419788	182	22	23	6	312	24
250	84	.0250.084.0	419728	419789	236	23	25	6	312	24
250	144	.0250.144.0	419729	419790	352	32	34	6	312	24
300	60	.0300.060.0	419730	419791	190	29	30	6	365	24
300	90	.0300.090.0	419731	419792	230	30	32	6	365	24
300	135	.0300.135.0	419732	419793	310	38	41	6	365	24
350	45	.0350.045.0	419733	419794	177	38	40	6	410	26
350	105	.0350.105.0	419734	419795	261	42	44	6	410	26
350	165	.0350.165.0	419735	419796	369	52	56	6	410	26
400	52	.0400.052.0	419736	419797	216	47	49	6	465	28
400	104	.0400.104.0	419737	419798	304	51	55	6	465	28
400	169	.0400.169.0	419738	419799	428	62	67	6	465	28
450	56	.0450.056.0	419739	419800	224	58	60	6	520	30
450	98	.0450.098.0	419740	419801	293	61	65	6	520	30
450	182	.0450.182.0	419741	419802	445	76	82	6	520	30
500	66	.0500.066.0	419742	419803	233	66	69	6	570	30
500	116	.0500.116.0	419743	419804	308	72	77	6	570	30
500	198	.0500.198.0	419744	419805	459	97	104	6	570	30
600	76	.0600.076.0	419746	419806	249	86	90	6	670	32
600	114	.0600.114.0	419747	419807	305	91	97	6	670	32
600	198	.0600.198.0	419748	419808	458	122	130	6	670	32

# TYPE ABN 06... PN 6

06

Bellows			Nominal movement absorption <sup>1)</sup>		Spring rate		
outside diameter	corrugated length	effective cross-section	angular	lateral	axial	angular	lateral
D <sub>s</sub>	l	A	2α <sub>N</sub>	2γ <sub>N</sub>	c <sub>0</sub>	c <sub>α</sub>	c <sub>γ</sub>
mm	mm	cm <sup>2</sup>	degree	mm	N/mm	Nm/deg	N/mm
316	72	670	18	3.9	209	39	5156
316	126	670	29	12	120	22	967
319	240	677	45	39	109	20	245
371	80	932	19	4.6	182	47	5062
371	120	932	27	10	121	31	1496
374	198	940	39	26	127	33	582
402	63	1110	13	2.5	281	87	15014
402	147	1110	28	14	120	37	1178
405	253	1119	40	37	119	37	397
461	88	1456	13	3.5	359	145	12887
461	176	1456	23	14	179	72	1606
462	299	1459	32	39	148	60	461
514	92	1828	13	3.6	364	185	15018
514	161	1828	23	12	208	106	2802
515	312	1832	30	39	150	76	539
572	100	2265	14	4.1	411	259	17778
572	175	2265	22	13	235	148	3319
574	324	2273	33	40	207	131	856
677	112	3217	13	4.4	412	368	20180
677	168	3217	19	10	275	246	5986
678	319	3222	29	33	235	210	1421

1) Inner sleeve, movement absorption: The inner sleeve is designed for axial movement only.

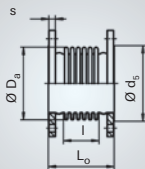
The movements (axial, angular, lateral) apply to 1000 load changes and are to be regarded as alternativ, i.e. the sum of their proportions in percentages should not exceed 100 %.

2) Available with other hole patterns / thicknesses on request. The overall length L0 may change then.

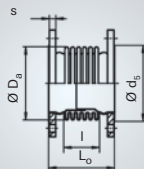


# AXIAL EXPANSION JOINTS WITH LOOSE FLANGES

Type ABN  
without inner  
sleeve



Type ABN  
with inner  
sleeve



06

Nominal diameter	Nominal axial movement absorption <sup>1)</sup>	Type ABN 06...	Order No. standard version		Overall length	Weight approx.		Flange <sup>2)</sup>		
			without inner sleeve	with inner sleeve		without inner sleeve	with inner sleeve	drilling as per EN 1092	rim diameter	thickness
DN	2 $\delta_N$	–	–	–	L <sub>o</sub>	G	G	PN	d <sub>s</sub>	s
–	mm	–	–	–	mm	kg	kg	–	mm	mm
700	60	.0700.060.0	419749	419809	224	111	114	6	775	36
700	120	.0700.120.0	419750	419810	308	120	127	6	775	36
700	200	.0700.200.0	419751	419811	442	151	160	6	775	36
800	63	.0800.063.0	419753	419812	251	148	152	6	880	37
800	105	.0800.105.0	419755	419813	317	160	167	6	880	37
800	210	.0800.210.0	419757	419814	482	189	201	6	880	37
900	63	.0900.063.0	419758	419815	253	162	167	6	980	38
900	105	.0900.105.0	419759	419816	319	175	184	6	980	38
900	210	.0900.210.0	419760	419817	484	209	222	6	980	38
1000	66	.1000.066.0	419761	419818	277	192	198	6	1080	42
1000	110	.1000.110.0	419762	419819	347	207	217	6	1080	42
1000	198	.1000.198.0	419763	419820	487	237	252	6	1080	42
1200	69	.1200.069.0	419764	419821	295	306	321	6	1290	47
1200	115	.1200.115.0	419765	419822	365	324	350	6	1290	47
1200	207	.1200.207.0	419766	419823	505	361	398	6	1290	47

# TYPE ABN 06...

## PN 6

06

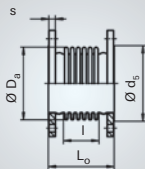
Bellows			Nominal movement absorption <sup>1)</sup>		Spring rate		
outside diameter	corrugated length	effective cross-section	angular	lateral	axial	angular	lateral
D <sub>s</sub>	l	A	2α <sub>N</sub>	2γ <sub>N</sub>	c <sub>0</sub>	c <sub>α</sub>	c <sub>γ</sub>
mm	mm	cm <sup>2</sup>	degree	mm	N/mm	Nm/deg	N/mm
780	84	4324	9.1	2.3	583	700	68235
780	168	4324	17	9.1	292	351	8544
783	300	4342	25	27	253	305	2331
887	99	5621	8.4	2.5	852	1330	93326
887	165	5621	14	6.8	511	798	20150
887	330	5621	23	27	256	400	2524
996	99	7163	7.4	2.2	949	1888	132463
996	165	7163	12	6	569	1132	28592
996	330	7163	20	24	285	567	3580
1100	105	8791	7	2.2	970	2369	147726
1100	175	8791	11	6.1	582	1421	31909
1100	315	8791	18	20	323	789	5466
1296	105	12341	6.2	1.9	1088	3730	232590
1296	175	12341	10	5.4	653	2238	50255
1296	315	12341	16	17	363	1244	8622

1) Inner sleeve, movement absorption: The inner sleeve is designed for axial movement only. The movements (axial, angular, lateral) apply to 1000 load changes and are to be regarded as alternativ, i.e. the sum of their proportions in percentages should not exceed 100 %.

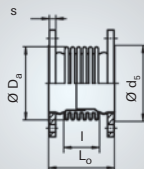
2) Available with other hole patterns / thicknesses on request. The overall length L0 may change then.

# AXIAL EXPANSION JOINTS WITH LOOSE FLANGES

Type ABN  
without inner  
sleeve



Type ABN  
with inner  
sleeve



Nominal diameter	Nominal axial movement absorption <sup>1)</sup>	Type ABN 10...	Order No. standard version		Overall length	Weight approx.		Flange <sup>2)</sup>		
			without inner sleeve	with inner sleeve		without inner sleeve	with inner sleeve	drilling as per EN 1092	rim diameter	thickness
DN	2 <sup>Δ</sup> N	–	–	–	L <sub>o</sub>	G	G	PN	d <sub>s</sub>	s
–	mm	–	–	–	mm	kg	kg	–	mm	mm
50	24	.0050.024.0	419824	419901	134	6	6	16	90	20
50	46	.0050.046.0	419825	419902	222	7	7	16	90	20
65	18	.0065.018.0	419826	419903	116	7	7	16	107	20
65	48	.0065.048.0	419827	419904	215	9	9	16	107	20
80	20	.0080.020.0	419828	419905	125	8	8	16	122	20
80	41	.0080.041.0	419829	419906	169	8	9	16	122	20
80	54	.0080.054.0	419830	419907	227	10	11	16	122	20
100	26	.0100.026.0	419831	419908	133	10	10	16	147	22
100	46	.0100.046.0	419832	419909	169	10	11	16	147	22
100	80	.0100.080.0	419833	419910	298	15	16	16	147	22
125	30	.0125.030.0	419834	419911	151	12	12	16	178	22
125	45	.0125.045.0	419835	419912	179	12	13	16	178	22
125	85	.0125.085.0	419836	419913	306	17	18	16	178	22
150	32	.0150.032.0	419837	419914	160	16	17	16	202	24
150	64	.0150.064.0	419838	419915	220	17	18	16	202	24
150	95	.0150.095.0	419839	419916	310	22	23	16	202	24
200	40	.0200.040.0	419840	419917	168	21	22	10	258	24
200	80	.0200.080.0	419841	434624	236	23	25	10	258	24
200	110	.0200.110.0	419842	419919	300	28	30	10	258	24
250	48	.0250.048.0	419843	419920	186	28	29	10	312	26
250	84	.0250.084.0	419855	419921	240	29	31	10	312	26
250	130	.0250.130.0	419856	419922	420	42	45	10	312	26

# TYPE ABN 10...

## PN 10

06

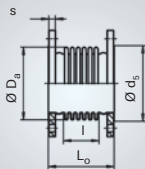
Bellows			Nominal movement absorption <sup>1)</sup>		Spring rate		
outside diameter	corrugated length	effective cross-section	angular	lateral	axial	angular	lateral
D <sub>s</sub>	l	A	2α <sub>N</sub>	2γ <sub>N</sub>	c <sub>0</sub>	c <sub>α</sub>	c <sub>γ</sub>
mm	mm	cm <sup>2</sup>	degree	mm	N/mm	Nm/deg	N/mm
89	54	46	30	5.6	86	1.1	259
90	140	46.6	48	28	112	1.4	51
107	36	68.7	21	2.4	126	2.4	1275
110	132	70.9	44	22	133	2.6	103
121	44	89.1	21	2.8	190	4.7	1670
121	88	89.1	34	11	95	2.4	209
123	144	90.8	43	24	135	3.4	113
149	48	138	21	3.2	159	6.1	1817
149	84	138	31	9.8	91	3.5	340
152	210	141	42	42	128	5	78
171	56	184	20	3.7	147	7.5	1646
171	84	184	27	8.2	98	5	488
174	208	187	40	38	136	7.1	113
203	60	264	19	3.5	254	19	3564
203	120	264	31	14	127	9.3	445
205	208	267	38	36	133	9.9	157
257	68	436	18	3.8	240	29	4318
257	136	436	28	15	120	15	540
260	198	441	35	31	138	17	297
316	72	670	17	3.9	209	39	5156
316	126	670	25	12	120	22	967
319	304	677	33	45	199	37	278

1) Inner sleeve, movement absorption: The inner sleeve is designed for axial movement only. The movements (axial, angular, lateral) apply to 1000 load changes and are to be regarded as alternativ, i.e. the sum of their proportions in percentages should not exceed 100 %.

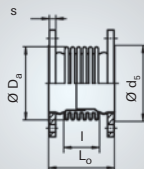
2) Available with other hole patterns / thicknesses on request. The overall length L0 may change then.

# AXIAL EXPANSION JOINTS WITH LOOSE FLANGES

Type ABN  
without inner  
sleeve



Type ABN  
with inner  
sleeve



Nominal diameter	Nominal axial movement absorption <sup>1)</sup>	Type ABN 10...	Order No. standard version		Overall length	Weight approx.		Flange <sup>2)</sup>		
			without inner sleeve	with inner sleeve		without inner sleeve	with inner sleeve	drilling as per EN 1092	rim diameter	thickness
DN	2 <sup>Δ</sup> N	–	–	–	L <sub>o</sub>	G	G	PN	d <sub>s</sub>	s
–	mm	–	–	–	mm	kg	kg	–	mm	mm
300	45	.0300.045.0	419857	419923	178	32	33	10	5.1	26
300	90	.0300.090.0	419858	419924	241	35	37	10	7.8	26
300	137	.0300.137.0	419859	419925	447	54	58	10	26.8	26
350	60	.0350.060.0	419882	419926	211	50	52	10	6.8	30
350	105	.0350.105.0	419883	419927	277	53	56	10	9.8	30
350	150	.0350.150.0	419884	419928	487	86	91	10	42.5	30
400	48	.0400.048.0	419885	419929	235	70	72	10	14.8	32
400	96	.0400.096.0	419886	419930	331	79	82	10	23.5	32
400	156	.0400.156.0	419887	419931	479	102	108	10	46.9	32
450	70	.0450.070.0	419888	419932	272	87	90	10	20.1	36
450	98	.0450.098.0	419889	419933	322	93	97	10	25.3	36
450	182	.0450.182.0	419890	419934	472	108	114	10	40.8	36
500	66	.0500.066.0	419891	419935	259	101	104	10	20.4	38
500	116	.0500.116.0	419892	419936	340	110	115	10	29.7	38
500	192	.0500.192.0	419893	419937	489	141	149	10	60.9	38
600	72	.0600.072.0	419894	419938	275	135	139	10	25.7	42
600	108	.0600.108.0	419895	419939	333	143	148	10	33.6	42
600	198	.0600.198.0	419896	419940	491	181	190	10	71.8	42
700	57	.0700.057.0	419897	419941	248	163	167	10	35.3	40
700	114	.0700.114.0	419898	419942	344	183	190	10	55	40
700	190	.0700.190.0	419899	419943	472	209	220	10	81.3	40

# TYPE ABN 10...

## PN 10

06

Bellows			Nominal movement absorption <sup>1)</sup>		Spring rate		
outside diameter	corrugated length	effective cross-section	angular	lateral	axial	angular	lateral
D <sub>s</sub>	l	A	2α <sub>N</sub>	2γ <sub>N</sub>	c <sub>0</sub>	c <sub>α</sub>	c <sub>γ</sub>
mm	mm	cm <sup>2</sup>	degree	mm	N/mm	Nm/deg	N/mm
372	63	935	14	2.7	290	75	13045
372	126	935	24	11	145	38	1631
374	330	940	31	44	237	62	391
403	88	1113	17	4.7	250	77	6864
403	154	1113	24	14	143	44	1282
412	360	1140	32	47	285	90	479
464	96	1466	12	3.6	723	294	21961
464	192	1466	22	14	362	147	2749
467	338	1476	30	41	287	118	708
518	125	1844	12	4.8	560	287	12620
518	175	1844	24	13	400	205	4599
518	325	1844	26	38	215	110	717
574	108	2273	13	4.4	620	392	23078
574	189	2273	21	14	354	224	4303
576	336	2282	29	40	279	177	1077
678	116	3222	12	4.3	645	577	29497
678	174	3222	17	9.8	430	385	8740
680	330	3232	26	34	316	284	1791
785	96	4353	8.6	2.4	1134	1371	102304
785	192	4353	16	9.8	567	686	12788
785	320	4353	22	27	340	411	2761

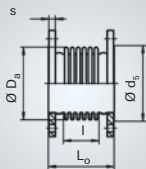
1) Inner sleeve, movement absorption: The inner sleeve is designed for axial movement only.

The movements (axial, angular, lateral) apply to 1000 load changes and are to be regarded as alternativ, i.e. the sum of their proportions in percentages should not exceed 100 %.

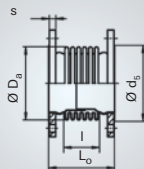
2) Available with other hole patterns / thicknesses on request. The overall length L0 may change then.

# AXIAL EXPANSION JOINTS WITH LOOSE FLANGES

Type ABN  
without inner  
sleeve



Type ABN  
with inner  
sleeve



Nominal diameter	Nominal axial movement absorption <sup>1)</sup>	Type ABN 16...	Order No. standard version		Overall length	Weight approx.		Flange <sup>2)</sup>		
			without inner sleeve	with inner sleeve		without inner sleeve	with inner sleeve	drilling as per EN 1092	rim diameter	thickness
DN	2 <sup>Δ</sup> <sub>N</sub>	–	–	–	L <sub>0</sub>	G	G	PN	d <sub>s</sub>	s
–	mm	–	–	–	mm	kg	kg	–	mm	mm
50	22	.0050.022.0	419944	419984	135	6	6	16	92	20
50	42	.0050.042.0	419945	419985	226	7	8	16	92	20
65	28	.0065.028.0	419946	419986	141	7	7	16	107	20
65	48	.0065.048.0	419947	419987	215	9	9	16	107	20
80	23	.0080.023.0	419948	419988	142	9	9	16	122	20
80	50	.0080.050.0	419949	419989	215	10	10	16	122	20
100	31	.0100.031.0	419950	419990	151	11	11	16	147	22
100	53	.0100.053.0	419951	419991	228	13	14	16	147	22
125	21	.0125.021.0	419952	419992	138	12	13	16	178	22
125	42	.0125.042.0	419953	419993	180	13	13	16	178	22
125	59	.0125.059.0	419954	419994	242	15	16	16	178	22
150	24	.0150.024.0	419955	419995	145	16	16	16	208	24
150	48	.0150.048.0	419956	419996	190	17	18	16	208	24
150	66	.0150.066.0	419957	419997	246	20	21	16	208	24
200	30	.0200.030.0	419958	419998	160	23	24	16	258	26
200	60	.0200.060.0	419959	419999	214	25	27	16	258	26
200	97	.0200.097.0	419960	420000	377	35	37	16	258	26
250	32	.0250.032.0	419961	420001	197	34	35	16	320	29
250	56	.0250.056.0	419962	420002	254	36	38	16	320	29
250	103	.0250.103.0	419963	420003	383	47	50	16	320	29

# TYPE ABN 16...

## PN 16

06

Bellows			Nominal movement absorption <sup>1)</sup>		Spring rate		
outside diameter	corrugated length	effective cross-section	angular	lateral	axial	angular	lateral
D <sub>s</sub>	l	A	2α <sub>N</sub>	2γ <sub>N</sub>	c <sub>0</sub>	c <sub>α</sub>	c <sub>γ</sub>
mm	mm	cm <sup>2</sup>	degree	mm	N/mm	Nm/deg	N/mm
89	54	46	28	5.2	143	1.8	430
91	143	47.2	40	26	149	2	66
108	60	69.4	27	5.9	124	2.4	457
110	132	70.9	37	22	133	2.6	103
122	60	89.9	22	4.3	273	6.8	1302
123	132	90.8	35	20	147	3.7	146
150	65	139	23	5	223	8.6	1400
152	140	141	33	18	192	7.5	264
172	42	185	15	1.9	346	18	6932
172	84	185	25	7.7	173	8.9	867
174	144	187	31	18	196	10	338
203	45	264	14	2	339	25	8455
203	90	264	24	7.8	169	12	1054
205	144	267	29	17	193	14	475
260	54	441	14	2.3	508	62	14678
260	108	441	24	9.1	254	31	1835
262	270	445	29	37	271	33	316
318	76	674	12	2.8	634	119	14135
318	133	674	19	8.5	362	68	2635
320	260	679	27	30	296	56	568

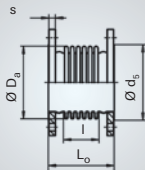
1) Inner sleeve, movement absorption: The inner sleeve is designed for axial movement only. The movements (axial, angular, lateral) apply to 1000 load changes and are to be regarded as alternativ, i.e. the sum of their proportions in percentages should not exceed 100 %.

2) Available with other hole patterns / thicknesses on request. The overall length L0 may change then.

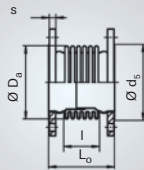


# AXIAL EXPANSION JOINTS WITH LOOSE FLANGES

Type ABN  
without inner  
sleeve



Type ABN  
with inner  
sleeve



06

Nominal diameter	Nominal axial movement absorption <sup>1)</sup>	Type ABN 16...	Order No. standard version		Overall length	Weight approx.		Flange <sup>2)</sup>		
			without inner sleeve	with inner sleeve		without inner sleeve	with inner sleeve	drilling as per EN 1092	rim diameter	thickness
DN	2 $\delta_N$	–	–	–	L <sub>o</sub>	G	G	PN	d <sub>s</sub>	s
–	mm	–	–	–	mm	kg	kg	–	mm	mm
300	30	.0300.030.0	419964	420004	191	46	47	16	375	32
300	80	.0300.080.0	419965	420005	296	52	55	16	375	32
300	120	.0300.120.0	419966	420006	476	75	79	16	375	32
350	30	.0350.030.0	419967	420007	197	65	66	16	410	35
350	80	.0350.080.0	419968	420008	302	72	75	16	410	35
350	130	.0350.130.0	419969	420009	449	94	99	16	410	35
400	48	.0400.048.0	419970	420010	257	92	94	16	465	38
400	84	.0400.084.0	419971	420011	335	101	105	16	465	38
400	132	.0400.132.0	419972	420012	439	113	118	16	465	38
450	52	.0450.052.0	419974	420014	265	116	119	16	520	42
450	91	.0450.091.0	419975	420015	343	127	131	16	520	42
450	143	.0450.143.0	419976	420016	447	141	146	16	520	42
500	48	.0500.048.0	419977	420017	253	152	155	16	570	46
500	96	.0500.096.0	419978	420018	337	165	169	16	570	46
500	144	.0500.144.0	419979	420019	421	177	183	16	570	46

# TYPE ABN 16...

## PN 16

06

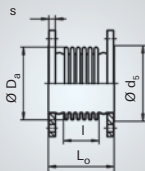
Bellows			Nominal movement absorption <sup>1)</sup>		Spring rate		
outside diameter	corrugated length	effective cross-section	angular	lateral	axial	angular	lateral
D <sub>s</sub>	l	A	2α <sub>N</sub>	2γ <sub>N</sub>	c <sub>0</sub>	c <sub>α</sub>	c <sub>γ</sub>
mm	mm	cm <sup>2</sup>	degree	mm	N/mm	Nm/deg	N/mm
374	63	940	9.6	1.8	930	243	42077
374	168	940	22	13	349	91	2220
376	345	946	24	40	322	85	489
408	63	1128	8.8	1.7	911	285	49455
408	168	1128	20	12	342	107	2611
412	312	1140	25	35	329	104	736
467	104	1476	12	3.8	934	383	24342
467	182	1476	19	12	534	219	4544
467	286	1476	24	29	340	139	1172
520	104	1851	12	3.7	943	485	30826
520	182	1851	21	13	539	277	5753
520	286	1851	23	28	343	176	1483
576	84	2282	9.9	2.5	1117	708	68986
576	168	2282	18	10	558	354	8616
576	252	2282	23	22	372	236	2553

1) Inner sleeve, movement absorption: The inner sleeve is designed for axial movement only. The movements (axial, angular, lateral) apply to 1000 load changes and are to be regarded as alternativ, i.e. the sum of their proportions in percentages should not exceed 100 %.

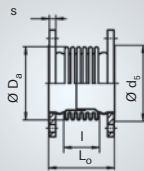
2) Available with other hole patterns / thicknesses on request. The overall length L0 may change then.

# AXIAL EXPANSION JOINTS WITH LOOSE FLANGES

Type ABN  
without inner  
sleeve



Type ABN  
with inner  
sleeve



Nominal diameter	Nominal axial movement absorption <sup>1)</sup>	Type ABN 25...	Order No. standard version		Overall length	Weight approx.		Flange <sup>2)</sup>		
			without inner sleeve	with inner sleeve		without inner sleeve	with inner sleeve	drilling as per EN 1092	rim diameter	thickness
DN	2 $\delta_N$	–	–	–	L <sub>0</sub>	G	G	PN	d <sub>5</sub>	s
–	mm	–	–	–	mm	kg	kg	–	mm	mm
50	13	.0050.013.0	420020	420071	122	6	6	40	92	20
50	29	.0050.029.0	420021	420072	182	7	7	40	92	20
65	17	.0065.017.0	420022	420073	130	8	8	40	107	22
65	40	.0065.040.0	420023	420074	220	10	10	40	107	22
80	23	.0080.023.0	420024	420075	151	10	11	40	122	24
80	42	.0080.042.0	420025	420076	222	12	12	40	122	24
100	23	.0100.023.0	420044	420077	147	14	15	40	147	26
100	48	.0100.048.0	420045	420078	222	16	17	40	147	26
125	26	.0125.026.0	420046	420079	174	19	20	40	178	28
125	52	.0125.052.0	420049	420080	238	21	21	40	178	28
150	29	.0150.029.0	420052	420081	178	24	25	40	208	30
150	58	.0150.058.0	420053	420082	242	26	27	40	208	30
200	26	.0200.026.0	420054	420083	190	34	35	25	258	32
200	46	.0200.046.0	420056	420098	244	36	37	25	258	32
200	71	.0200.071.0	420057	420099	317	41	43	25	258	32
250	24	.0250.024.0	420058	420100	195	47	49	25	320	35
250	48	.0250.048.0	420059	420101	255	51	53	25	320	35
250	79	.0250.079.0	420061	420102	335	56	58	25	320	35
300	27	.0300.027.0	420062	420103	207	62	64	25	375	38
300	55	.0300.055.0	420063	420104	273	67	69	25	375	38
300	82	.0300.082.0	420064	420107	339	72	75	25	375	38

# TYPE ABN 25...

## PN 25

06

Bellows			Nominal movement absorption <sup>1)</sup>		Spring rate		
outside diameter	corrugated length	effective cross-section	angular	lateral	axial	angular	lateral
D <sub>s</sub>	l	A	2α <sub>N</sub>	2λ <sub>N</sub>	c <sub>0</sub>	c <sub>α</sub>	c <sub>λ</sub>
mm	mm	cm <sup>2</sup>	degree	mm	N/mm	Nm/deg	N/mm
90	40	46.6	19	2.3	391	5.1	2173
91	99	47.2	32	12	215	2.8	198
109	44	70.1	19	2.6	334	6.5	2311
111	132	71.6	33	18	212	4.2	166
123	60	90.8	22	4.2	323	8.1	1555
125	130	92.5	32	17	217	5.6	227
151	52	140	18	3	334	13	3302
152	126	141	30	15	213	8.3	361
174	64	187	18	3.6	442	23	3864
174	128	187	29	14	221	12	483
205	64	267	17	3.4	434	32	5410
205	128	267	27	14	217	16	676
261	72	443	12	2.6	843	104	13759
261	126	443	18	8	482	59	2569
262	198	445	23	20	370	46	802
320	60	679	9	1.6	1281	242	46135
320	120	679	16	6.5	640	121	5762
320	200	679	21	18	384	72	1245
374	66	940	8.7	1.7	1186	310	48892
374	132	940	16	7	593	155	6112
374	198	940	19	16	395	103	1809

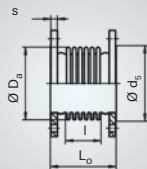
1) Inner sleeve, movement absorption: The inner sleeve is designed for axial movement only.

The movements (axial, angular, lateral) apply to 1000 load changes and are to be regarded as alternativ, i.e. the sum of their proportions in percentages should not exceed 100 %.

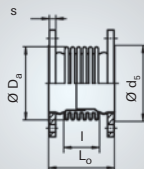
2) Available with other hole patterns / thicknesses on request. The overall length L0 may change then.

# AXIAL EXPANSION JOINTS WITH LOOSE FLANGES

Type ABN  
without inner  
sleeve



Type ABN  
with inner  
sleeve



06

Nom- inal dia- meter	Nominal axial movement absorption <sup>1)</sup>	Type  ABN 25...	Order No. standard version		Overall length	Weight approx.		Flange <sup>2)</sup>		
			without inner sleeve	with inner sleeve		without inner sleeve	with inner sleeve	drilling as per EN 1092	rim diameter	thick- ness
DN	2 $\delta_N$	–	–	–	L <sub>o</sub>	G	G	PN	d <sub>s</sub>	s
–	mm	–	–	–	mm	kg	kg	–	mm	mm
350	30	.0350.030.0	420065	420108	223	98	100	25	410	42
350	50	.0350.050.0	420066	420109	271	103	105	25	410	42
350	80	.0350.080.0	420067	420110	343	110	113	25	410	42
400	32	.0400.032.0	420068	420111	273	137	140	25	465	48
400	56	.0400.056.0	420069	420112	348	147	150	25	465	48
400	96	.0400.096.0	420070	420113	499	171	177	25	465	48

# TYPE ABN 25...

## PN 25

06

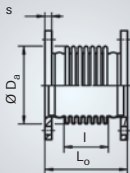
Bellows			Nominal movement absorption <sup>1)</sup>		Spring rate		
outside diameter	corrugated length	effective cross-section	angular	lateral	axial	angular	lateral
$D_s$	$l$	$A$	$2c_{\alpha N}$	$2c_{\lambda N}$	$c_0$	$c_{\alpha}$	$c_{\lambda}$
mm	mm	cm <sup>2</sup>	degree	mm	N/mm	Nm/deg	N/mm
412	72	1140	8.8	1.9	1425	451	59854
412	120	1140	14	5.2	855	271	12928
412	192	1140	19	13	534	169	3154
466	100	1473	8.1	2.5	1908	780	53659
466	175	1473	13	7.5	1090	446	10010
469	324	1483	18	24	689	284	1859

1) Inner sleeve, movement absorption: The inner sleeve is designed for axial movement only. The movements (axial, angular, lateral) apply to 1000 load changes and are to be regarded as alternativ, i.e. the sum of their proportions in percentages should not exceed 100 %.

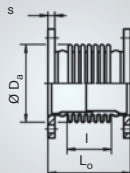
2) Available with other hole patterns / thicknesses on request. The overall length L0 may change then.

# AXIAL EXPANSION JOINTS WITH PLAIN FIXED FLANGES

Type AFN  
without inner  
sleeve



Type AFN  
with inner  
sleeve



Nominal diameter	Nominal axial movement absorption <sup>1)</sup>	Type AFN 02...	Order No. standard version		Overall length	Weight approx.		Flange <sup>2)</sup>	
			without inner sleeve	with inner sleeve		without inner sleeve	with inner sleeve	drilling as per EN 1092	thickness
DN	2 <sub>N</sub>	–	–	–	L <sub>o</sub>	G	G	PN	s
–	mm	–	–	–	mm	kg	kg	–	mm
50	20	.0050.020.0	421681	421833	129	3.2	3.4	6	16
50	40	.0050.040.0	421682	421834	174	3.4	3.6	6	16
50	70	.0050.070.0	421683	421835	255	3.9	4.3	6	16
65	23	.0065.023.0	421684	421836	129	4.1	4.3	6	16
65	60	.0065.060.0	421685	421837	201	4.4	4.8	6	16
65	87	.0065.087.0	421686	421838	274	5	6	6	16
80	27	.0080.027.0	421687	421839	136	6	7	6	18
80	64	.0080.064.0	421688	421840	206	7	7	6	18
80	92	.0080.092.0	421689	421841	284	7	8	6	18
100	46	.0100.046.0	421690	421842	163	7	8	6	18
100	73	.0100.073.0	421691	421843	207	8	8	6	18
100	98	.0100.098.0	421692	421844	294	10	11	6	18
125	45	.0125.045.0	421693	421845	163	9	10	6	20
125	81	.0125.081.0	421694	421846	215	10	10	6	20
125	140	.0125.140.0	421695	421847	378	14	15	6	20
150	45	.0150.045.0	421696	421848	163	10	11	6	20
150	81	.0150.081.0	421697	421849	215	11	12	6	20
150	160	.0150.160.0	421698	421850	398	16	18	6	20
200	60	.0200.060.0	421699	421851	190	15	16	6	22
200	110	.0200.110.0	421700	421852	276	17	19	6	22
200	190	.0200.190.0	421701	421853	423	22	25	6	22

# TYPE AFN 02... PN 2.5

06

Bellows			Nominal movement absorption <sup>1)</sup>		Spring rate		
outside diameter	corrugated length	effective cross-section	angular	lateral	axial	angular	lateral
D <sub>s</sub>	l	A	2α <sub>N</sub>	2λ <sub>N</sub>	c <sub>0</sub>	c <sub>α</sub>	c <sub>λ</sub>
mm	mm	cm <sup>2</sup>	degree	mm	N/mm	Nm/deg	N/mm
89	45	46	29	3.9	104	1.3	451
89	90	46	50	16	52	0.7	56
89	171	46	50	52	45	0.6	14
107	45	68.7	28	3.7	101	1.9	654
107	117	68.7	50	25	39	0.7	37
108	190	69.4	50	59	39	0.8	14
121	50	89.1	28	4.1	94	2.3	640
121	120	89.1	50	24	39	1	46
121	198	89.1	50	57	42	1.1	18
148	77	137	37	9	62	2.4	273
148	121	137	50	22	40	1.5	71
150	208	139	50	51	70	2.7	43
174	65	187	31	6.3	58	3	492
174	117	187	49	20	32	1.7	84
172	280	185	50	85	52	2.7	23
203	65	264	27	5.3	67	5	801
203	117	264	43	17	37	2.8	137
203	300	264	50	87	51	3.7	29
255	90	432	27	7.7	62	7.4	631
256	176	434	44	27	50	6	134
257	323	436	50	87	51	6.2	41

1) Inner sleeve, movement absorption: The inner sleeve is designed for axial movement only.

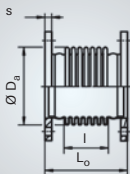
The movements (axial, angular, lateral) apply to 1000 load changes and are to be regarded as alternativ, i.e. the sum of their proportions in percentages should not exceed 100 %.

2) Available with other hole patterns / thicknesses on request. The overall length L0 may change then.

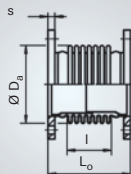


# AXIAL EXPANSION JOINTS WITH PLAIN FIXED FLANGES

Type AFN  
without inner  
sleeve



Type AFN  
with inner  
sleeve



Nominal diameter	Nominal axial movement absorption <sup>1)</sup>	Type AFN 02...	Order No. standard version		Overall length	Weight approx.		Flange <sup>2)</sup>	
			without inner sleeve	with inner sleeve		without inner sleeve	with inner sleeve	drilling as per EN 1092	thickness
DN	2 <sub>N</sub>	–	–	–	L <sub>o</sub>	G	G	PN	s
–	mm	–	–	–	mm	kg	kg	–	mm
250	72	.0250.072.0	421702	421854	214	20	21	6	24
250	120	.0250.120.0	421703	421855	282	22	24	6	24
250	204	.0250.204.0	421704	421856	418	29	32	6	24
300	56	.0300.056.0	421705	421857	188	25	28	6	24
300	126	.0300.126.0	421706	421858	283	27	31	6	24
300	210	.0300.210.0	421707	421859	392	35	41	6	24
350	60	.0350.060.0	421708	421860	194	35	38	6	26
350	120	.0350.120.0	421709	421861	274	38	42	6	26
350	210	.0350.210.0	421710	421863	408	46	53	6	26
400	65	.0400.065.0	421711	421864	230	44	48	6	28
400	104	.0400.104.0	421712	421865	293	46	51	6	28
400	182	.0400.182.0	421713	421866	419	50	58	6	28
450	56	.0450.056.0	421714	421867	217	54	57	6	30
450	112	.0450.112.0	421715	421868	305	57	63	6	30
450	182	.0450.182.0	421716	421869	415	61	69	6	30
500	68	.0500.068.0	421717	421870	221	58	63	6	30
500	119	.0500.119.0	421718	421871	290	61	67	6	30
500	204	.0500.204.0	421719	421872	405	66	75	6	30
600	76	.0600.076.0	421720	421873	237	76	82	6	32
600	114	.0600.114.0	421721	421874	289	79	86	6	32
600	209	.0600.209.0	421722	421875	419	85	96	6	32

# TYPE AFN 02... PN 2.5

06

Bellows			Nominal movement absorption <sup>1)</sup>		Spring rate		
outside diameter	corrugated length	effective cross-section	angular	lateral	axial	angular	lateral
D <sub>s</sub>	l	A	2α <sub>N</sub>	2λ <sub>N</sub>	c <sub>0</sub>	c <sub>α</sub>	c <sub>λ</sub>
mm	mm	cm <sup>2</sup>	degree	mm	N/mm	Nm/deg	N/mm
312	102	661	26	8.4	62	11	752
315	170	667	39	23	48	8.9	212
316	306	670	50	71	49	9.3	67
365	76	916	18	4.2	91	23	2756
365	171	916	34	21	40	10	239
371	280	932	50	57	52	13	118
400	80	1104	17	4.3	82	25	2703
402	160	1110	32	17	58	18	480
402	294	1110	49	55	60	19	147
458	105	1445	17	5.3	211	85	5283
458	168	1445	26	14	132	53	1291
458	294	1445	39	42	75	31	240
513	88	1825	13	3.4	243	123	10935
513	176	1825	25	14	121	62	1361
513	286	1825	35	36	75	38	320
569	92	2252	14	3.9	214	135	10875
569	161	2252	24	12	122	77	2025
569	276	2252	35	35	71	45	401
674	104	3202	13	4.1	214	191	12099
674	156	3202	19	9.3	143	127	3593
674	286	3202	31	31	78	69	583

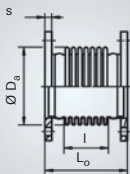
1) Inner sleeve, movement absorption: The inner sleeve is designed for axial movement only.

The movements (axial, angular, lateral) apply to 1000 load changes and are to be regarded as alternativ, i.e. the sum of their proportions in percentages should not exceed 100 %.

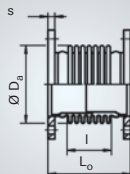
2) Available with other hole patterns / thicknesses on request. The overall length L0 may change then.

# AXIAL EXPANSION JOINTS WITH PLAIN FIXED FLANGES

Type AFN  
without inner  
sleeve



Type AFN  
with inner  
sleeve



Nominal diameter	Nominal axial movement absorption <sup>1)</sup>	Type AFN 02...	Order No. standard version		Overall length	Weight approx.		Flange <sup>2)</sup>	
			without inner sleeve	with inner sleeve		without inner sleeve	with inner sleeve	drilling as per EN 1092	thickness
DN	2 <sub>N</sub>	–	–	–	L <sub>0</sub>	G	G	PN	s
–	mm	–	–	–	mm	kg	kg	–	mm
700	80	.0700.080.0	421723	421876	240	94	101	6	32
700	120	.0700.120.0	421724	421877	296	97	106	6	32
700	220	.0700.220.0	421725	421878	436	105	119	6	32
800	63	.0800.063.0	421727	421879	227	120	126	6	34
800	126	.0800.126.0	421728	421880	314	126	137	6	34
800	210	.0800.210.0	421729	421881	430	133	149	6	34
900	63	.0900.063.0	421730	421882	232	130	136	6	35
900	126	.0900.126.0	421731	421883	322	137	150	6	35
900	210	.0900.210.0	421732	421884	442	145	164	6	35
1000	72	.1000.072.0	421733	421885	252	148	156	6	37
1000	120	.1000.120.0	421734	421886	316	153	167	6	37
1000	240	.1000.240.0	421735	421887	476	165	187	6	37
1200	72	.1200.072.0	421736	421888	266	19	216	2	40
1200	120	.1200.120.0	421737	421889	330	28	237	2	40
1200	216	.1200.216.0	421738	421890	458	47	264	2	40
1400	48	.1400.048.0	421739	421891	178	245	257	2	42
1400	108	.1400.108.0	421740	421892	308	257	280	2	42
1400	180	.1400.180.0	421741	421893	464	271	310	2	42
1600	48	.1600.048.0	421742	421894	186	333	347	2	46
1600	108	.1600.108.0	421743	421895	316	347	374	2	46
1600	180	.1600.180.0	421744	421896	472	364	408	2	46

# TYPE AFN 02... PN 2.5

06

Bellows			Nominal movement absorption <sup>1)</sup>		Spring rate		
outside diameter	corrugated length	effective cross-section	angular	lateral	axial	angular	lateral
D <sub>s</sub>	l	A	2c <sub>αN</sub>	2λ <sub>Nl</sub>	c <sub>0</sub>	c <sub>α</sub>	c <sub>λ</sub>
mm	mm	cm <sup>2</sup>	degree	mm	N/mm	Nm/deg	N/mm
780	112	4324	12	4	203	244	13365
780	168	4324	17	9.1	135	162	3950
780	308	4324	27	30	74	89	644
882	87	5588	8.4	2.2	293	456	41313
882	174	5588	16	8.7	147	228	5182
882	290	5588	24	24	88	137	1117
992	90	7133	7.4	2	316	628	53147
992	180	7133	14	7.9	158	313	6643
992	300	7133	21	22	95	188	1438
1095	96	8750	7.7	2.2	335	814	60745
1095	160	8750	13	6.1	201	489	13121
1095	320	8750	22	24	100	245	1632
1295	96	12331	6.5	1.8	511	1750	130579
1295	160	12331	11	5.1	306	1052	28150
1295	288	12331	18	17	170	582	4827
1456	104	16016	3.8	1.2	911	4053	257632
1456	234	16016	8.4	5.9	405	1802	22624
1456	390	16016	13	16	243	1081	4887
1656	104	20816	3.3	1	1035	5990	380429
1656	234	20816	7.4	5.2	460	2660	33398
1656	390	20816	12	14	276	1596	7214

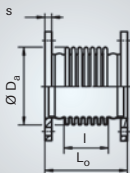
1) Inner sleeve, movement absorption: The inner sleeve is designed for axial movement only.

The movements (axial, angular, lateral) apply to 1000 load changes and are to be regarded as alternativ, i.e. the sum of their proportions in percentages should not exceed 100 %.

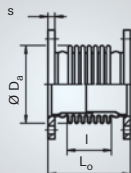
2) Available with other hole patterns / thicknesses on request. The overall length L0 may change then.

# AXIAL EXPANSION JOINTS WITH PLAIN FIXED FLANGES

Type AFN  
without inner  
sleeve



Type AFN  
with inner  
sleeve



06

Nom- inal dia- meter	Nominal axial movement absorption <sup>1)</sup>	Type  AFN 02...	Order No. standard version		Overall length	Weight approx.		Flange <sup>2)</sup>	
			without inner sleeve	with inner sleeve		without inner sleeve	with inner sleeve	drilling as per EN 1092	thickness
DN	2 $\delta_N$	–	–	–	L <sub>o</sub>	G	G	PN	s
–	mm	–	–	–	mm	kg	kg	–	mm
1800	48	.1800.048.0	421752	421897	194	404	420	2	50
1800	108	.1800.108.0	421753	421898	324	420	450	2	50
1800	180	.1800.180.0	421754	421899	480	438	488	2	50
2000	48	.2000.048.0	421755	421900	198	465	482	2	52
2000	108	.2000.108.0	421757	421901	328	482	516	2	52
2000	180	.2000.180.0	421759	421902	484	502	558	2	52

# TYPE AFN 02...

## PN 2.5

06

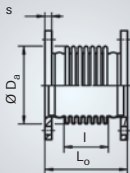
Bellows			Nominal movement absorption <sup>1)</sup>		Spring rate		
outside diameter	corrugated length	effective cross-section	angular	lateral	axial	angular	lateral
$D_s$	$l$	$A$	$2\alpha_N$	$2\lambda_N$	$c_0$	$c_{\alpha}$	$c_{\lambda}$
mm	mm	cm <sup>2</sup>	degree	mm	N/mm	Nm/deg	N/mm
1856	104	26245	3	0.9	1158	8449	536643
1856	234	26245	6.6	4.6	515	3754	47143
1856	390	26245	11	13	309	2253	10183
2056	104	32302	2.7	0.8	1281	11503	730650
2056	234	32302	6	4.2	569	5114	64107
2056	390	32302	9.6	12	342	3069	13872

1) Inner sleeve, movement absorption: The inner sleeve is designed for axial movement only. The movements (axial, angular, lateral) apply to 1000 load changes and are to be regarded as alternativ, i.e. the sum of their proportions in percentages should not exceed 100 %.

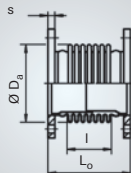
2) Available with other hole patterns / thicknesses on request. The overall length L0 may change then.

# AXIAL EXPANSION JOINTS WITH PLAIN FIXED FLANGES

Type AFN  
without inner  
sleeve



Type AFN  
with inner  
sleeve



Nominal diameter	Nominal axial movement absorption <sup>1)</sup>	Type AFN 06...	Order No. standard version		Overall length	Weight approx.		Flange <sup>2)</sup>	
			without inner sleeve	with inner sleeve		without inner sleeve	with inner sleeve	drilling as per EN 1092	thickness
DN	2 <sub>N</sub>	–	–	–	L <sub>o</sub>	G	G	PN	s
–	mm	–	–	–	mm	kg	kg	–	mm
50	20	.0050.020.0	421903	421960	129	3.2	3.4	6	16
50	52	.0050.052.0	421904	421961	210	3.7	4.1	6	16
65	23	.0065.023.0	421905	421962	129	4.1	4.3	6	16
65	41	.0065.041.0	421906	421963	165	4.2	4.6	6	16
65	72	.0065.072.0	421907	421964	282	6	7	6	16
80	27	.0080.027.0	421908	421965	136	6	7	6	18
80	42	.0080.042.0	421909	421966	166	7	7	6	18
80	77	.0080.077.0	421910	421967	290	9	10	6	18
100	33	.0100.033.0	421911	421968	141	7	7	6	18
100	59	.0100.059.0	421912	421969	194	8	8	6	18
100	87	.0100.087.0	421913	421970	281	10	11	6	18
125	36	.0125.036.0	421914	421971	150	9	10	6	20
125	63	.0125.063.0	421915	421972	189	9	10	6	20
125	98	.0125.098.0	421916	421973	308	13	14	6	20
150	40	.0150.040.0	421917	422009	168	11	11	6	20
150	72	.0150.072.0	421918	422010	233	13	14	6	20
150	124	.0150.124.0	421919	422011	370	18	20	6	20
200	40	.0200.040.0	421920	422012	164	15	16	6	22
200	80	.0200.080.0	421921	422013	236	18	19	6	22
200	140	.0200.140.0	421922	422014	352	25	27	6	22

# TYPE AFN 06...

## PN 6

06

Bellows			Nominal movement absorption <sup>1)</sup>		Spring rate		
outside diameter	corrugated length	effective cross-section	angular	lateral	axial	angular	lateral
D <sub>s</sub>	l	A	2α <sub>N</sub>	2λ <sub>N</sub>	c <sub>0</sub>	c <sub>α</sub>	c <sub>λ</sub>
mm	mm	cm <sup>2</sup>	degree	mm	N/mm	Nm/deg	N/mm
89	45	46	28	3.9	104	1.3	451
89	126	46	50	28	61	0.8	34
107	45	68.7	27	3.7	101	1.9	654
107	81	68.7	42	12	56	1.1	112
110	198	70.9	50	50	88	1.8	30
121	50	89.1	27	4.1	94	2.3	640
121	80	89.1	38	11	58	1.5	154
123	204	90.8	50	48	95	2.4	40
148	55	137	27	4.6	87	3.3	752
149	108	138	43	16	71	2.7	160
151	195	140	50	42	89	3.5	63
174	52	187	25	4	72	3.7	953
174	91	187	39	12	41	2.1	177
173	210	186	50	45	88	4.6	71
202	70	263	23	5.1	116	8.5	1189
203	135	264	39	18	113	8.4	313
205	272	267	50	61	102	7.7	70
256	64	434	19	3.6	138	17	2791
257	136	436	34	15	120	15	540
260	252	441	50	50	109	13	145

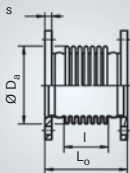
1) Inner sleeve, movement absorption: The inner sleeve is designed for axial movement only. The movements (axial, angular, lateral) apply to 1000 load changes and are to be regarded as alternativ, i.e. the sum of their proportions in percentages should not exceed 100 %.

2) Available with other hole patterns / thicknesses on request. The overall length L0 may change then.

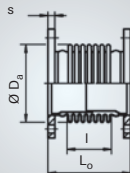


# AXIAL EXPANSION JOINTS WITH PLAIN FIXED FLANGES

Type AFN  
without inner  
sleeve



Type AFN  
with inner  
sleeve



Nominal diameter	Nominal axial movement absorption <sup>1)</sup>	Type AFN 06...	Order No. standard version		Overall length	Weight approx.		Flange <sup>2)</sup>	
			without inner sleeve	with inner sleeve		without inner sleeve	with inner sleeve	drilling as per EN 1092	thickness
DN	2 <sub>N</sub>	–	–	–	L <sub>o</sub>	G	G	PN	s
–	mm	–	–	–	mm	kg	kg	–	mm
250	48	.0250.048.0	421923	422015	184	21	22	6	24
250	84	.0250.084.0	421924	422016	238	23	25	6	24
250	144	.0250.144.0	421925	422017	352	31	34	6	24
300	60	.0300.060.0	421926	422018	192	28	30	6	24
300	90	.0300.090.0	421927	422019	232	29	33	6	24
300	135	.0300.135.0	421928	422020	310	37	41	6	24
350	45	.0350.045.0	421929	422022	177	37	39	6	26
350	105	.0350.105.0	421930	422023	261	41	44	6	26
350	165	.0350.165.0	421931	422024	367	51	56	6	26
400	52	.0400.052.0	421932	422025	213	46	48	6	28
400	104	.0400.104.0	421933	422026	301	50	55	6	28
400	169	.0400.169.0	421934	422027	424	61	68	6	28
450	56	.0450.056.0	421935	422029	221	56	59	6	30
450	98	.0450.098.0	421936	422030	290	60	65	6	30
450	182	.0450.182.0	421937	422031	441	74	82	6	30
500	66	.0500.066.0	421938	422033	229	64	68	6	30
500	116	.0500.116.0	421939	422034	304	70	77	6	30
500	198	.0500.198.0	421941	422036	453	94	104	6	30
600	76	.0600.076.0	421942	422037	245	83	89	6	32
600	114	.0600.114.0	421943	422038	301	89	96	6	32
600	198	.0600.198.0	421944	422039	452	118	130	6	32

# TYPE AFN 06...

## PN 6

06

Bellows			Nominal movement absorption <sup>1)</sup>		Spring rate		
outside diameter	corrugated length	effective cross-section	angular	lateral	axial	angular	lateral
D <sub>s</sub>	l	A	2α <sub>N</sub>	2λ <sub>N</sub>	c <sub>0</sub>	c <sub>α</sub>	c <sub>λ</sub>
mm	mm	cm <sup>2</sup>	degree	mm	N/mm	Nm/deg	N/mm
316	72	670	18	3.9	209	39	5156
316	126	670	29	12	120	22	967
319	240	677	45	39	109	21	245
371	80	932	19	4.6	182	47	5062
371	120	932	27	10	121	32	1496
374	198	940	39	26	127	33	582
402	63	1110	13	2.5	281	87	15014
402	147	1110	28	14	120	37	1178
405	253	1119	40	37	119	37	397
461	88	1456	13	3.5	359	146	12887
461	176	1456	23	14	179	73	1606
462	299	1459	32	39	148	60	461
514	92	1828	13	3.6	364	186	15018
514	161	1828	20	11	208	106	2802
515	312	1832	30	39	150	76	539
572	100	2265	14	4.1	411	260	17778
572	175	2265	22	13	235	148	3319
574	324	2273	33	40	207	131	856
677	112	3217	13	4.4	412	370	20180
677	168	3217	19	10	275	247	5986
678	319	3222	29	33	235	211	1421

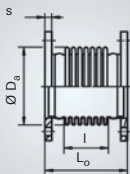
1) Inner sleeve, movement absorption: The inner sleeve is designed for axial movement only.

The movements (axial, angular, lateral) apply to 1000 load changes and are to be regarded as alternativ, i.e. the sum of their proportions in percentages should not exceed 100 %.

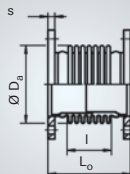
2) Available with other hole patterns / thicknesses on request. The overall length L0 may change then.

# AXIAL EXPANSION JOINTS WITH PLAIN FIXED FLANGES

Type AFN  
without inner  
sleeve



Type AFN  
with inner  
sleeve



Nominal diameter	Nominal axial movement absorption <sup>1)</sup>	Type AFN 06...	Order No. standard version		Overall length	Weight approx.		Flange <sup>2)</sup>	
			without inner sleeve	with inner sleeve		without inner sleeve	with inner sleeve	drilling as per EN 1092	thickness
DN	2 $\delta_N$	–	–	–	L <sub>o</sub>	G	G	PN	s
–	mm	–	–	–	mm	kg	kg	–	mm
700	60	.0700.060.0	421945	422040	220	107	111	6	36
700	120	.0700.120.0	421946	422041	304	117	126	6	36
700	200	.0700.200.0	421947	422042	436	146	159	6	36
800	63	.0800.063.0	421948	422044	245	142	147	6	37
800	105	.0800.105.0	421949	422046	311	153	164	6	37
800	210	.0800.210.0	421950	422047	476	183	199	6	37
900	63	.0900.063.0	421951	422048	247	155	162	6	38
900	105	.0900.105.0	421952	422049	313	169	180	6	38
900	210	.0900.210.0	421953	422050	478	202	221	6	38
1000	66	.1000.066.0	421954	422051	271	184	192	6	42
1000	110	.1000.110.0	421955	422053	341	199	213	6	42
1000	198	.1000.198.0	421956	422054	481	229	250	6	42
1200	69	.1200.069.0	421957	422055	289	295	308	6	47
1200	115	.1200.115.0	421958	422056	359	313	337	6	47
1200	207	.1200.207.0	421959	422057	499	349	384	6	47

# TYPE AFN 06...

## PN 6

06

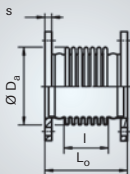
Bellows			Nominal movement absorption <sup>1)</sup>		Spring rate		
outside diameter	corrugated length	effective cross-section	angular	lateral	axial	angular	lateral
D <sub>s</sub>	l	A	2α <sub>N</sub>	2λ <sub>N</sub>	c <sub>0</sub>	c <sub>α</sub>	c <sub>λ</sub>
mm	mm	cm <sup>2</sup>	degree	mm	N/mm	Nm/deg	N/mm
780	84	4324	9.1	2.3	583	703	68235
780	168	4324	17	9.1	292	352	8544
783	300	4342	25	27	253	308	2331
887	99	5621	8.4	2.5	852	1337	93326
887	165	5621	14	6.8	511	803	20150
887	330	5621	23	27	256	401	2524
996	99	7163	7.4	2.2	949	1896	132463
996	165	7163	12	6	569	1138	28592
996	330	7163	20	24	285	569	3580
1100	105	8791	7	2.2	970	2379	147726
1100	175	8791	11	6.1	582	1426	31909
1100	315	8791	18	20	323	794	5466
1296	105	12341	6.2	1.9	1088	3743	232590
1296	175	12341	10	5.4	653	2245	50255
1296	315	12341	16	17	363	1248	8622

1) Inner sleeve, movement absorption: The inner sleeve is designed for axial movement only. The movements (axial, angular, lateral) apply to 1000 load changes and are to be regarded as alternativ, i.e. the sum of their proportions in percentages should not exceed 100 %.

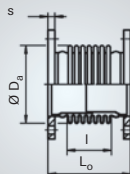
2) Available with other hole patterns / thicknesses on request. The overall length L0 may change then.

# AXIAL EXPANSION JOINTS WITH PLAIN FIXED FLANGES

Type AFN  
without inner  
sleeve



Type AFN  
with inner  
sleeve



Nominal diameter	Nominal axial movement absorption <sup>1)</sup>	Type AFN 10...	Order No. standard version		Overall length	Weight approx.		Flange <sup>2)</sup>	
			without inner sleeve	with inner sleeve		without inner sleeve	with inner sleeve	drilling as per EN 1092	thickness
DN	2 <sub>N</sub>	–	–	–	L <sub>o</sub>	G	G	PN	s
–	mm	–	–	–	mm	kg	kg	–	mm
50	24	.0050.024.0	422058	422104	142	6	6	16	20
50	46	.0050.046.0	422059	422105	228	7	7	16	20
65	18	.0065.018.0	422060	422106	124	7	7	16	20
65	48	.0065.048.0	422061	422107	220	8	9	16	20
80	20	.0080.020.0	422062	422108	132	8	8	16	20
80	41	.0080.041.0	422063	422109	176	8	8	16	20
80	54	.0080.054.0	422064	422110	232	9	10	16	20
100	26	.0100.026.0	422065	422111	138	9	10	16	22
100	46	.0100.046.0	422066	422112	174	10	10	16	22
100	80	.0100.080.0	422067	422113	300	14	15	16	22
125	30	.0125.030.0	422068	422115	156	12	12	16	22
125	45	.0125.045.0	422069	422116	184	12	12	16	22
125	85	.0125.085.0	422070	422117	308	16	17	16	22
150	32	.0150.032.0	422071	422118	162	16	16	16	24
150	64	.0150.064.0	422072	422119	222	17	18	16	24
150	95	.0150.095.0	422073	422120	310	21	23	16	24
200	40	.0200.040.0	422074	422121	170	21	22	10	24
200	80	.0200.080.0	422075	422122	238	23	24	10	24
200	110	.0200.110.0	422076	422123	300	27	29	10	24
250	48	.0250.048.0	422077	422124	186	27	28	10	26
250	84	.0250.084.0	422078	422125	240	29	30	10	26
250	130	.0250.130.0	422079	422126	418	41	44	10	26

# TYPE AFN 10... PN 10

06

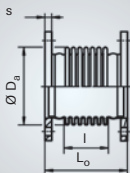
Bellows			Nominal movement absorption <sup>1)</sup>		Spring rate		
outside diameter	corrugated length	effective cross-section	angular	lateral	axial	angular	lateral
D <sub>s</sub>	l	A	2c <sub>αN</sub>	2λ <sub>N</sub>	c <sub>0</sub>	c <sub>α</sub>	c <sub>λ</sub>
mm	mm	cm <sup>2</sup>	degree	mm	N/mm	Nm/deg	N/mm
89	54	46	30	5.6	86	1.1	259
90	140	46.6	48	28	112	1.5	51
107	36	68.7	21	2.4	126	2.4	1275
110	132	70.9	44	22	133	2.7	103
121	44	89.1	21	2.8	190	4.8	1670
121	88	89.1	34	11	95	2.4	209
123	144	90.8	43	24	135	3.5	113
149	48	138	21	3.2	159	6.2	1817
149	84	138	31	9.8	91	3.5	340
152	210	141	42	42	128	5.1	78
171	56	184	20	3.7	147	7.6	1646
171	84	184	27	8.2	98	5.1	488
174	208	187	40	38	136	7.2	113
203	60	264	19	3.5	254	19	3564
203	120	264	31	14	127	9.4	445
205	208	267	38	36	133	10	157
257	68	436	18	3.8	240	29	4318
257	136	436	28	15	120	15	540
260	198	441	35	31	138	17	297
316	72	670	17	3.9	209	39	5156
316	126	670	25	12	120	22	967
319	304	677	33	45	199	38	278

1) Inner sleeve, movement absorption: The inner sleeve is designed for axial movement only. The movements (axial, angular, lateral) apply to 1000 load changes and are to be regarded as alternativ, i.e. the sum of their proportions in percentages should not exceed 100 %.

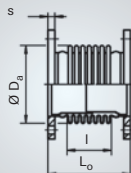
2) Available with other hole patterns / thicknesses on request. The overall length L0 may change then.

# AXIAL EXPANSION JOINTS WITH PLAIN FIXED FLANGES

Type AFN  
without inner  
sleeve



Type AFN  
with inner  
sleeve



Nominal diameter	Nominal axial movement absorption <sup>1)</sup>	Type AFN 10...	Order No. standard version		Overall length	Weight approx.		Flange <sup>2)</sup>	
			without inner sleeve	with inner sleeve		without inner sleeve	with inner sleeve	drilling as per EN 1092	thickness
DN	2 <sub>N</sub>	–	–	–	L <sub>o</sub>	G	G	PN	s
–	mm	–	–	–	mm	kg	kg	–	mm
300	45	.0300.045.0	422080	422127	177	31	33	10	26
300	90	.0300.090.0	422081	422128	240	34	37	10	26
300	137	.0300.137.0	422082	424785	444	52	58	10	26
350	60	.0350.060.0	422083	422130	207	49	52	10	30
350	105	.0350.105.0	422084	422131	273	52	56	10	30
350	150	.0350.150.0	422085	422132	479	83	90	10	30
400	48	.0400.048.0	422086	422133	229	67	70	10	32
400	96	.0400.096.0	422087	422134	325	76	81	10	32
400	156	.0400.156.0	422088	422135	471	98	106	10	32
450	70	.0450.070.0	422090	422136	266	84	89	10	36
450	98	.0450.098.0	422091	422137	316	89	95	10	36
450	182	.0450.182.0	422092	422138	466	105	113	10	36
500	66	.0500.066.0	422093	422139	253	97	102	10	38
500	116	.0500.116.0	422094	422140	334	106	113	10	38
500	192	.0500.192.0	422095	422141	481	136	146	10	38
600	72	.0600.072.0	422096	422142	269	130	136	10	42
600	108	.0600.108.0	422098	422143	327	138	145	10	42
600	198	.0600.198.0	422099	422144	483	174	186	10	42
700	57	.0700.057.0	422100	422145	240	156	160	10	40
700	114	.0700.114.0	422101	422146	336	175	185	10	40
700	190	.0700.190.0	422103	422147	464	202	215	10	40

# TYPE AFN 10... PN 10

06

Bellows			Nominal movement absorption <sup>1)</sup>		Spring rate		
outside diameter	corrugated length	effective cross-section	angular	lateral	axial	angular	lateral
D <sub>s</sub>	l	A	2α <sub>N</sub>	2λ <sub>N</sub>	c <sub>0</sub>	c <sub>α</sub>	c <sub>λ</sub>
mm	mm	cm <sup>2</sup>	degree	mm	N/mm	Nm/deg	N/mm
372	63	935	14	2.7	290	76	13045
372	126	935	24	11	145	38	1631
374	330	940	31	44	237	63	391
403	88	1113	17	4.7	250	78	6864
403	154	1113	24	14	143	45	1282
412	360	1140	32	47	285	92	479
464	96	1466	12	3.6	723	297	21961
464	192	1466	22	14	362	149	2749
467	338	1476	30	41	287	119	708
518	125	1844	16	6	560	289	12620
518	175	1844	21	12	400	206	4599
518	325	1844	28	41	215	111	717
574	108	2273	13	4.4	620	395	23078
574	189	2273	21	14	354	225	4303
576	336	2282	29	40	279	179	1077
678	116	3222	12	4.3	645	581	29497
678	174	3222	17	9.8	430	388	8740
680	330	3232	26	34	316	286	1791
785	96	4353	8.6	2.4	1134	1381	102304
785	192	4353	16	9.8	567	690	12788
785	320	4353	22	27	340	415	2761

1) Inner sleeve, movement absorption: The inner sleeve is designed for axial movement only.

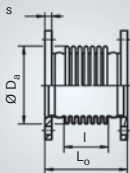
The movements (axial, angular, lateral) apply to 1000 load changes and are to be regarded as alternativ, i.e. the sum of their proportions in percentages should not exceed 100 %.

2) Available with other hole patterns / thicknesses on request. The overall length L0 may change then.

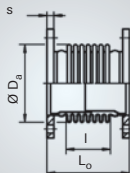


# AXIAL EXPANSION JOINTS WITH PLAIN FIXED FLANGES

Type AFN  
without inner  
sleeve



Type AFN  
with inner  
sleeve



Nominal diameter	Nominal axial movement absorption <sup>1)</sup>	Type AFN 16...	Order No. standard version		Overall length	Weight approx.		Flange <sup>2)</sup>	
			without inner sleeve	with inner sleeve		without inner sleeve	with inner sleeve	drilling as per EN 1092	thickness
DN	2 <sub>N</sub>	–	–	–	L <sub>o</sub>	G	G	PN	s
–	mm	–	–	–	mm	kg	kg	–	mm
50	22	.0050.022.0	422148	422183	142	6	6	16	20
50	42	.0050.042.0	422149	422184	231	7	7	16	20
65	28	.0065.028.0	422150	422185	148	7	7	16	20
65	48	.0065.048.0	422151	422186	220	8	9	16	20
80	23	.0080.023.0	422152	422187	148	8	8	16	20
80	50	.0080.050.0	422153	422188	220	9	10	16	20
100	31	.0100.031.0	422154	422189	155	10	10	16	22
100	53	.0100.053.0	422155	422190	230	12	13	16	22
125	21	.0125.021.0	422156	422191	142	12	12	16	22
125	42	.0125.042.0	422157	422192	184	13	13	16	22
125	59	.0125.059.0	422158	422193	244	15	16	16	22
150	24	.0150.024.0	422159	422194	147	16	16	16	24
150	48	.0150.048.0	422160	422195	192	16	17	16	24
150	66	.0150.066.0	422161	422196	246	19	20	16	24
200	30	.0200.030.0	422162	422197	158	23	23	16	26
200	60	.0200.060.0	422163	422198	212	25	26	16	26
200	97	.0200.097.0	422164	422199	374	34	36	16	26
250	32	.0250.032.0	422165	422200	193	33	34	16	29
250	56	.0250.056.0	422166	422202	250	35	37	16	29
250	103	.0250.103.0	422167	422203	377	46	48	16	29

# TYPE AFN 16...

## PN 16

06

Bellows			Nominal movement absorption <sup>1)</sup>		Spring rate		
outside diameter	corrugated length	effective cross-section	angular	lateral	axial	angular	lateral
D <sub>s</sub>	l	A	2α <sub>N</sub>	2λ <sub>N</sub>	c <sub>0</sub>	c <sub>α</sub>	c <sub>λ</sub>
mm	mm	cm <sup>2</sup>	degree	mm	N/mm	Nm/deg	N/mm
89	54	46	28	5.2	143	1.9	430
91	143	47.2	40	26	149	2	66
108	60	69.4	27	5.9	124	2.4	457
110	132	70.9	37	22	133	2.7	103
122	60	89.9	22	4.3	273	6.9	1302
123	132	90.8	35	20	147	3.8	146
150	65	139	23	5	223	8.8	1400
152	140	141	33	18	192	7.7	264
172	42	185	15	1.9	346	18	6932
172	84	185	25	7.7	173	9	867
174	144	187	31	18	196	10	338
203	45	264	14	2	339	25	8455
203	90	264	24	7.8	169	13	1054
205	144	267	29	17	193	15	475
260	54	441	14	2.3	508	63	14678
260	108	441	24	9.1	254	31	1835
262	270	445	29	37	271	34	316
318	76	674	12	2.8	634	120	14135
318	133	674	19	8.5	362	69	2635
320	260	679	27	30	296	57	568

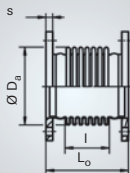
1) Inner sleeve, movement absorption: The inner sleeve is designed for axial movement only.

The movements (axial, angular, lateral) apply to 1000 load changes and are to be regarded as alternativ, i.e. the sum of their proportions in percentages should not exceed 100 %.

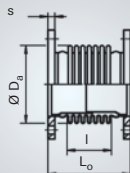
2) Available with other hole patterns / thicknesses on request. The overall length L0 may change then.

# AXIAL EXPANSION JOINTS WITH PLAIN FIXED FLANGES

Type AFN  
without inner  
sleeve



Type AFN  
with inner  
sleeve



Nominal diameter	Nominal axial movement absorption <sup>1)</sup>	Type AFN 16...	Order No. standard version		Overall length	Weight approx.		Flange <sup>2)</sup>	
			without inner sleeve	with inner sleeve		without inner sleeve	with inner sleeve	drilling as per EN 1092	thickness
DN	2 <sup>6)</sup> <sub>N</sub>	–	–	–	L <sub>o</sub>	G	G	PN	s
–	mm	–	–	–	mm	kg	kg	–	mm
300	30	.0300.030.0	422168	422204	186	44	46	16	32
300	80	.0300.080.0	422169	422205	291	50	54	16	32
300	120	.0300.120.0	422170	422206	468	72	78	16	32
350	30	.0350.030.0	422171	422207	192	63	65	16	35
350	80	.0350.080.0	422172	422208	297	70	74	16	35
350	130	.0350.130.0	422173	422209	441	91	97	16	35
400	48	.0400.048.0	422174	422210	249	88	91	16	38
400	84	.0400.084.0	422175	422211	327	97	102	16	38
400	132	.0400.132.0	422176	422212	431	109	116	16	38
450	52	.0450.052.0	422177	422213	257	111	114	16	42
450	91	.0450.091.0	422178	422214	335	122	127	16	42
450	143	.0450.143.0	422179	422215	439	136	144	16	42
500	48	.0500.048.0	422180	422216	245	146	149	16	46
500	96	.0500.096.0	422181	422217	329	159	165	16	46
500	144	.0500.144.0	422182	422218	413	171	179	16	46

# TYPE AFN 16...

## PN 16

06

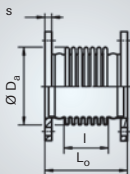
Bellows			Nominal movement absorption <sup>1)</sup>		Spring rate		
outside diameter	corrugated length	effective cross-section	angular	lateral	axial	angular	lateral
D <sub>s</sub>	l	A	2α <sub>N</sub>	2λ <sub>N</sub>	c <sub>0</sub>	c <sub>α</sub>	c <sub>λ</sub>
mm	mm	cm <sup>2</sup>	degree	mm	N/mm	Nm/deg	N/mm
374	63	940	9.6	1.8	930	246	42077
374	168	940	22	13	349	92	2220
376	345	946	24	40	322	86	489
408	63	1128	8.8	1.7	911	288	49455
408	168	1128	20	12	342	108	2611
412	312	1140	25	35	329	106	736
467	104	1476	12	3.8	934	388	24342
467	182	1476	19	12	534	222	4544
467	286	1476	24	29	340	141	1172
520	104	1851	12	3.7	943	491	30826
520	182	1851	19	11	539	280	5753
520	286	1851	23	28	343	178	1483
576	84	2282	9.9	2.5	1117	715	68986
576	168	2282	18	10	558	357	8616
576	252	2282	23	22	372	238	2553

1) Inner sleeve, movement absorption: The inner sleeve is designed for axial movement only. The movements (axial, angular, lateral) apply to 1000 load changes and are to be regarded as alternativ, i.e. the sum of their proportions in percentages should not exceed 100 %.

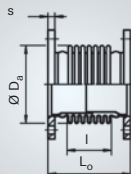
2) Available with other hole patterns / thicknesses on request. The overall length L0 may change then.

# AXIAL EXPANSION JOINTS WITH PLAIN FIXED FLANGES

Type AFN  
without inner  
sleeve



Type AFN  
with inner  
sleeve



Nominal diameter	Nominal axial movement absorption <sup>1)</sup>	Type AFN 25...	Order No. standard version		Overall length	Weight approx.		Flange <sup>2)</sup>	
			without inner sleeve	with inner sleeve		without inner sleeve	with inner sleeve	drilling as per EN 1092	thickness
DN	2 <sub>N</sub>	–	–	–	L <sub>o</sub>	G	G	PN	s
–	mm	–	–	–	mm	kg	kg	–	mm
50	13	.0050.013.0	422219	422248	128	6	6	40	20
50	29	.0050.029.0	422220	422249	187	6	7	40	20
65	17	.0065.017.0	422221	422250	134	8	8	40	22
65	40	.0065.040.0	422222	422251	222	9	10	40	22
80	23	.0080.023.0	422223	422252	152	10	10	40	24
80	42	.0080.042.0	422224	422253	222	11	12	40	24
100	23	.0100.023.0	422225	422254	146	13	14	40	26
100	48	.0100.048.0	422227	422255	220	15	16	40	26
125	26	.0125.026.0	422228	422256	169	19	19	40	28
125	52	.0125.052.0	422230	422257	233	20	21	40	28
150	29	.0150.029.0	422231	422258	173	23	24	40	30
150	58	.0150.058.0	422232	422259	237	25	26	40	30
200	26	.0200.026.0	422233	422260	185	33	34	25	32
200	46	.0200.046.0	422234	422261	239	35	36	25	32
200	71	.0200.071.0	422235	422262	311	40	41	25	32
250	24	.0250.024.0	422236	422263	189	46	47	25	35
250	48	.0250.048.0	422237	422264	249	49	51	25	35
250	79	.0250.079.0	422238	422265	329	54	56	25	35
300	27	.0300.027.0	422239	422266	201	60	62	25	38
300	55	.0300.055.0	422240	422267	267	65	67	25	38
300	82	.0300.082.0	422241	422268	333	69	73	25	38

# TYPE AFN 25... PN 25

06

Bellows			Nominal movement absorption <sup>1)</sup>		Spring rate		
outside diameter	corrugated length	effective cross-section	angular	lateral	axial	angular	lateral
D <sub>s</sub>	l	A	2c <sub>αN</sub>	2λ <sub>N</sub>	c <sub>0</sub>	c <sub>α</sub>	c <sub>λ</sub>
mm	mm	cm <sup>2</sup>	degree	mm	N/mm	Nm/deg	N/mm
90	40	46.6	19	2.3	391	5.1	2173
91	99	47.2	32	12	215	2.8	198
109	44	70.1	19	2.6	334	6.5	2311
111	132	71.6	33	18	212	4.2	166
123	60	90.8	22	4.2	323	8.1	1555
125	130	92.5	32	17	217	5.6	227
151	52	140	18	3	334	13	3302
152	126	141	30	15	213	8.3	361
174	64	187	18	3.6	442	23	3864
174	128	187	29	14	221	12	483
205	64	267	17	3.4	434	32	5410
205	128	267	27	14	217	16	676
261	72	443	12	2.6	843	104	13759
261	126	443	18	8	482	59	2569
262	198	445	23	20	370	46	802
320	60	679	9	1.6	1281	242	46135
320	120	679	16	6.5	640	121	5762
320	200	679	21	18	384	72	1245
374	66	940	8.7	1.7	1186	310	48892
374	132	940	16	7	593	155	6112
374	198	940	19	16	395	103	1809

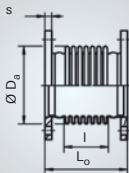
1) Inner sleeve, movement absorption: The inner sleeve is designed for axial movement only.

The movements (axial, angular, lateral) apply to 1000 load changes and are to be regarded as alternativ, i.e. the sum of their proportions in percentages should not exceed 100 %.

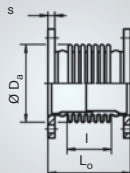
2) Available with other hole patterns / thicknesses on request. The overall length L0 may change then.

# AXIAL EXPANSION JOINTS WITH PLAIN FIXED FLANGES

Type AFN  
without inner  
sleeve



Type AFN  
with inner  
sleeve



Nom- inal dia- meter	Nominal axial movement absorption <sup>1)</sup>	Type AFN 25...	Order No. standard version		Overall length	Weight approx.		Flange <sup>2)</sup>	
			without inner sleeve	with inner sleeve		without inner sleeve	with inner sleeve	drilling as per EN 1092	thickness
DN	2 $\delta_N$	–	–	–	L <sub>0</sub>	G	G	PN	s
–	mm	–	–	–	mm	kg	kg	–	mm
350	30	.0350.030.0	422242	422269	215	94	96	25	42
350	50	.0350.050.0	422243	422270	263	99	102	25	42
350	80	.0350.080.0	422244	422271	335	106	111	25	42
400	32	.0400.032.0	422245	422272	265	132	135	25	48
400	56	.0400.056.0	422246	422273	340	142	146	25	48
400	96	.0400.096.0	422247	422274	489	166	173	25	48

# TYPE AFN 25... PN 25

06

Bellows			Nominal movement absorption <sup>1)</sup>		Spring rate		
outside diameter	corrugated length	effective cross-section	angular	lateral	axial	angular	lateral
$D_s$	$l$	$A$	$2\alpha_N$	$2\lambda_N$	$c_0$	$c_{\alpha}$	$c_{\lambda}$
mm	mm	cm <sup>2</sup>	degree	mm	N/mm	Nm/deg	N/mm
412	72	1140	8.8	1.9	1425	451	59854
412	120	1140	14	5.2	855	271	12928
412	192	1140	19	13	534	169	3154
466	100	1473	8.1	2.5	1908	780	53659
466	175	1473	13	7.5	1090	446	10010
469	324	1483	18	24	689	284	1859

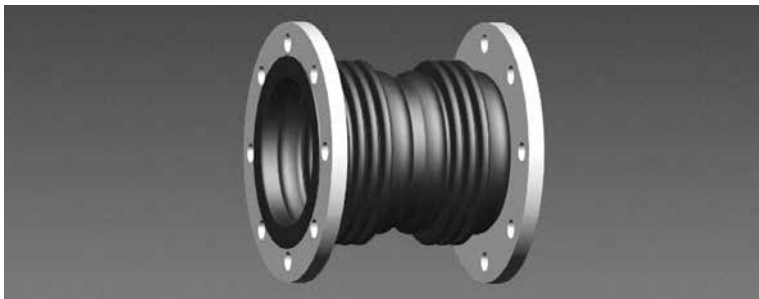
1) Inner sleeve, movement absorption: The inner sleeve is designed for axial movement only. The movements (axial, angular, lateral) apply to 1000 load changes and are to be regarded as alternativ, i.e. the sum of their proportions in percentages should not exceed 100 %.

2) Available with other hole patterns / thicknesses on request. The overall length L0 may change then.



# UNIVERSAL EXPANSION JOINTS FOR LOW PRESSURE (EXHAUST) WITH FLANGES TYPE UBN, UFN

06



## Type designation

The type designation consists of 2 parts

1. Type series, defined by 3 letters
2. Nominal size, defined by 10 digits

## Example

Type UBN: HYDRA low pressure expansion joint with loose flanges

Type UFN: HYDRA low pressure expansion joint with plain fixed flanges

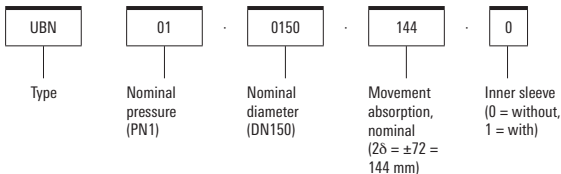
## Standard version/materials:

Multi-ply bellows made of 1.4541

Flange made of S235JRG2 (1.0038) or P250GH (1.0460)

Operating temperature: up to 550 °C

## Type designation (example)



## Order text

Please state the following with your order:

For standard versions

- Type designation or order number

With material variation

- Type designation
- Details of materials

The expansion joints for low pressure (exhaust-gas) are designed for unpressurized applications (PS < 0.5 bar gauge pressure).

The Pressure Equipment Directive (PED) does not apply to this operating condition.

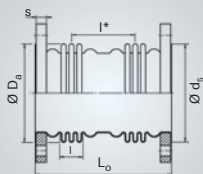
## Information

Tell us the dimensions that deviate from the standard and we customize the expansion joint to your specification.

On request, flanges can also be supplied with other hole patterns / flange sheet thicknesses. In this case, the specified overall length L0 may change.

# UNIVERSAL EXPANSION JOINTS FOR LOW PRESSURE WITH LOOSE FLANGES

Type UBN



06

Nominal diameter	Nominal axial movement absorption <sup>1)</sup>	Type UBN 01...	Order No. standard version	Overall length	Weight approx.	Centre-to-centre distance of bellows	Flange <sup>2)</sup>		
							drilling EN 1092	rim diameter	thickness
DN	2δ <sub>N</sub>	–	–	L <sub>0</sub>	G	I*	PN	d <sub>5</sub>	s
–	mm	–	–	mm	kg	mm	–	mm	mm
50	56	.0050.056.0	425669	392	3.8	257	6	90	16
65	82.8	.0065.083.0	425670	432	5	279	6	107	16
80	95.4	.0080.095.0	425673	446	7	280	6	122	18
100	118.8	.0100.119.0	425674	466	9	291	6	147	18
125	144	.0125.144.0	425675	480	11	286	6	178	20
150	144	.0150.144.0	423511	493	12	299	6	202	20
200	160	.0200.160.0	423512	506	17	292	6	258	22
250	168	.0250.168.0	423513	520	22	293	6	312	24
300	196	.0300.196.0	423514	510	29	269	6	365	24
350	180	.0350.180.0	423515	534	39	302	6	410	26
400	156	.0400.156.0	423516	519	51	266	6	465	28
450	140	.0450.140.0	423517	523	61	282	6	520	30
500	136	.0500.136.0	423518	533	66	310	6	570	30

# TYPE UBN 01... PN 1

06

Bellows			Nominal movement absorption <sup>1)</sup>		Spring rate		
outside diameter	corrugated length	effective cross-section	angular	lateral	axial	angular	lateral
D <sub>s</sub>	l	A	2c <sub>αN</sub>	2λ <sub>N</sub>	c <sub>0</sub>	c <sub>α</sub>	c <sub>λ</sub>
mm	mm	cm <sup>2</sup>	degree	mm	N/mm	Nm/deg	N/mm
89	63	46	41	154	37	0.9	1.6
107	81	68.7	49	197	28	1.1	1.5
121	90	89.1	49	196	26	1.3	1.8
148	99	137	49	203	24	1.8	2.4
174	104	187	49	204	18	1.9	2.5
203	104	264	42	181	21	3.1	3.8
255	120	432	37	149	23	5.5	7
312	119	661	31	127	27	9.9	12
365	133	916	31	112	26	13	19
400	120	1104	26	109	27	17	20
458	126	1445	20	71	88	71	106
513	110	1825	16	62	97	98	135
569	92	2252	14	62	107	134	155

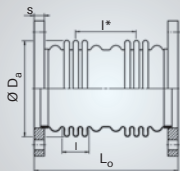
1) Inner sleeve, movement absorption: The inner sleeve is designed for axial movement only.

The movements (axial, angular, lateral) apply to 1000 load changes and are to be regarded as alternativ, i.e. the sum of their proportions in percentages should not exceed 100 %.

2) Available with other hole patterns / thicknesses on request. The overall length L0 may change then.

# UNIVERSAL EXPANSION JOINTS FOR LOW PRESSURE WITH PLAIN FIXED FLANGES

Type UFN



06

Nominal diameter	Nominal axial movement absorption <sup>1)</sup>	Type UFN 01...	Order No. standard version	Overall length	Weight approx.	Centre-to-centre distance of bellows	Flange <sup>2)</sup>	
							drilling EN 1092	thickness
DN	2 $\delta_N$	–	–	L <sub>0</sub>	G	I*	PN	s
–	mm	–	–	mm	kg	mm	-	mm
50	56	.0050.056.0	425685	404	3.7	257	6	16
65	83	.0065.083.0	425686	444	4.9	279	6	16
80	95	.0080.095.0	425687	456	7	280	6	18
100	119	.0100.119.0	425688	476	8	291	6	18
125	144	.0125.144.0	425689	488	11	286	6	20
150	144	.0150.144.0	423527	501	12	299	6	20
200	160	.0200.160.0	423528	512	17	292	6	22
250	168	.0250.168.0	423529	524	22	293	6	24
300	196	.0300.196.0	423530	514	29	269	6	24
350	180	.0350.180.0	423531	536	39	302	6	26
400	156	.0400.156.0	423532	517	51	266	6	28
450	140	.0450.140.0	423533	521	61	282	6	30
500	136	.0500.136.0	423534	531	65	310	6	30

# TYPE UFN 01... PN 1

06

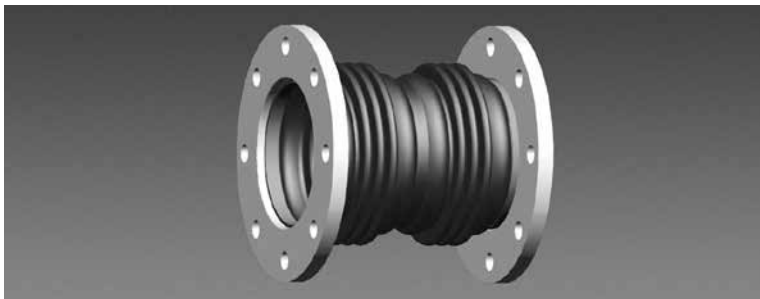
Bellows			Nominal movement absorption <sup>1)</sup>		Spring rate		
outside diameter	corrugated length	effective cross-section	angular	lateral	axial	angular	lateral
$D_s$	$l$	$A$	$2c_{\alpha N}$	$2c_{\lambda N}$	$c_0$	$c_{\alpha}$	$c_{\lambda}$
mm	mm	cm <sup>2</sup>	degree	mm	N/mm	Nm/deg	N/mm
89	63	46	41	154	37	0.9	1.6
107	81	68.7	49	197	28	1.1	1.5
121	90	89.1	49	196	26	1.3	1.8
148	99	137	49	203	24	1.8	2.4
174	104	187	49	204	18	1.9	2.5
203	104	264	42	181	21	3.1	3.8
255	120	432	37	149	23	5.5	7
312	119	661	31	127	27	9.9	12
365	133	916	31	112	26	13	19
400	120	1104	26	109	27	17	20
458	126	1445	20	71	88	71	106
513	110	1825	16	62	97	98	135
569	92	2252	14	62	107	134	155

1) Inner sleeve, movement absorption: The inner sleeve is designed for axial movement only. The movements (axial, angular, lateral) apply to 1000 load changes and are to be regarded as alternativ, i.e. the sum of their proportions in percentages should not exceed 100 %.

2) Available with other hole patterns / thicknesses on request. The overall length L0 may change then.

# UNIVERSAL EXPANSION JOINTS WITH FLANGES TYPE UBN, UFN

06



## Type designation

The type designation consists of 2 parts

1. Type series, defined by 3 letters
2. Nominal size, defined by 10 digits

## Example

Type UBN: HYDRA Universal expansion joint with loose flanges

Type UFN: HYDRA Universal expansion joint with plain fixed flanges

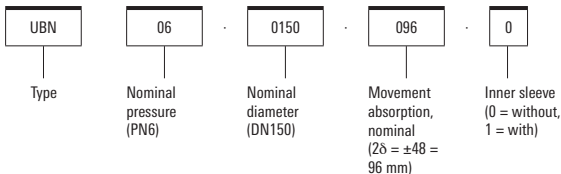
## Standard design/Materials

Multi-ply bellows made of 1.4541

Flange made of S235JRG2 (1.0038) or P250GH (1.0460)

Operating temperature: up to 300 °C / 450 °C

## Type designation (example)



## Order text according to guideline 2014/68/EU "Pressure Equipment Directive"

Please state the following with your order:

For standard versions

- Type designation or order number

With material variation

- Type designation
- Details of the materials

According to the Pressure Equipment Directive, the following information is required for testing and documentation:

06

Type of pressure equipment according to Art. 1 & 2:

- Vessel - volume V [l] \_\_\_\_\_
- Piping - nominal diameter DN \_\_\_\_\_

Medium property according to Art. 13:

- Group 1 – dangerous
- Group 2 – all other fluids

State of medium

- Gaseous or liquid if PD > 0.5 bar
- Liquid if PD ≤ 0.5 bar

Design data:

- Max. allowable pressure [bar] \_\_\_\_\_
- Max./min. allowable temperature [°C] \_\_\_\_\_
- Test pressure PT [bar] \_\_\_\_\_

Optional:

- Category \_\_\_\_\_

### Note

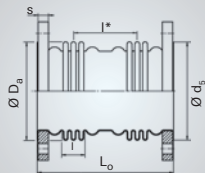
Tell us the dimensions that deviate from the standard and we customize the expansion joint to your specification.

On request, flanges can also be supplied with other hole patterns / flange sheet thicknesses. In this case, the specified overall length L0 may change.



# UNIVERSAL EXPANSION JOINTS WITH LOOSE FLANGES

Type UBN



06

Nominal diameter	Nominal axial movement absorption <sup>1)</sup>	Type UBN 06...	Order No. standard version	Overall length	Weight approx.	Centre-to-centre distance of bellows	Flange <sup>2)</sup>		
							drilling EN 1092	rim diameter	thickness
DN	$2\delta_n$	–	–	$L_o$	G	$I^*$	PN	$d_s$	s
–	mm	–	–	mm	kg	mm	–	mm	mm
50	44	.0050.044.0	425677	343	4.1	216	6	90	16
65	55	.0065.055.0	425678	343	5	210	6	107	16
80	61	.0080.061.0	425680	367	8	224	6	122	18
100	73	.0100.073.0	425681	388	10	232	6	147	18
125	84	.0125.084.0	425683	416	13	240	6	178	20
150	96	.0150.096.0	423519	433	15	251	6	202	20
200	100	.0200.100.0	423520	474	21	293	6	258	22
250	120	.0250.120.0	423521	414	26	214	6	312	24
300	100	.0300.100.0	423522	434	31	230	6	365	24
350	110	.0350.110.0	423523	444	42	231	6	410	26
400	130	.0400.130.0	423524	465	55	227	6	465	28
450	140	.0450.140.0	423525	489	68	242	6	520	30
500	132	.0500.132.0	423526	499	79	266	6	570	30

# TYPE UBN 06...

## PN 6

06

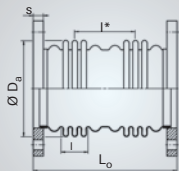
Bellows			Nominal movement absorption <sup>1)</sup>		Spring rate		
outside diameter	corrugated length	effective cross-section	angular	lateral	axial	angular	lateral
$D_s$	$l$	$A$	$2\alpha_N$	$2\lambda_N$	$c_a$	$c_{\alpha}$	$c_{\lambda}$
mm	mm	cm <sup>2</sup>	degree	mm	N/mm	Nm/deg	N/mm
89	54	46	31	102	72	1.8	4.4
108	60	69.4	31	99	62	2.4	6
121	66	89.1	30	102	63	3.1	7
150	78	139	29	99	93	7.2	15
172	84	185	29	101	87	8.9	17
203	90	264	27	101	85	12	22
257	85	436	23	99	96	23	30
316	90	670	22	66	84	31	73
371	95	932	16	50	111	57	118
405	100	1119	15	50	109	68	137
461	110	1456	16	50	144	116	239
514	115	1828	16	51	146	148	269
572	100	2265	14	50	206	259	400

1) Inner sleeve, movement absorption: The inner sleeve is designed for axial movement only. The movements (axial, angular, lateral) apply to 1000 load changes and are to be regarded as alternativ, i.e. the sum of their proportions in percentages should not exceed 100 %.

2) Available with other hole patterns / thicknesses on request. The overall length L0 may change then.

# UNIVERSAL EXPANSION JOINTS WITH PLAIN FIXED FLANGES

Type UFN



06

Nominal diameter	Nominal axial movement absorption <sup>1)</sup>	Type UFN 06...	Order No. standard version	Overall length	Weight approx.	Centre-to-centre bellows distance	Flange <sup>2)</sup>	
							drilling EN 1092	thickness
DN	2 $\delta_n$	–	–	L <sub>o</sub>	G	I*	PN	s
–	mm	–	–	mm	kg	mm	-	mm
50	44	.0050.044.0	425690	354	3.9	216	6	16
65	55	.0065.055.0	425691	354	5	210	6	16
80	61	.0080.061.0	425693	376	7	224	6	18
100	73	.0100.073.0	425694	396	10	232	6	18
125	84	.0125.084.0	425695	422	13	240	6	20
150	96	.0150.096.0	423535	439	15	251	6	20
200	100	.0200.100.0	423536	478	20	293	6	22
250	120	.0250.120.0	423537	416	26	214	6	24
300	100	.0300.100.0	423538	437	31	230	6	24
350	110	.0350.110.0	423539	445	42	231	6	26
400	130	.0400.130.0	423540	462	54	227	6	28
450	140	.0450.140.0	423541	486	66	242	6	30
500	132	.0500.132.0	423542	495	77	266	6	30

# TYPE UFN 06...

## PN 6

06

Bellows			Nominal movement absorption <sup>1)</sup>		Spring rate		
outside diameter	corrugated length	effective cross-section	angular	lateral	axial	angular	lateral
D <sub>s</sub>	l	A	2c <sub>αN</sub>	2λ <sub>N</sub>	c <sub>0</sub>	c <sub>α</sub>	c <sub>λ</sub>
mm	mm	cm <sup>2</sup>	degree	mm	N/mm	Nm/deg	N/mm
89	54	46	31	102	72	1.8	4.4
108	60	69.4	31	99	62	2.4	6
121	66	89.1	30	102	63	3.1	7
150	78	139	29	99	93	7.2	15
172	84	185	29	101	87	8.9	17
203	90	264	27	101	85	12	22
257	85	436	23	99	96	23	30
316	90	670	22	66	84	31	73
371	95	932	16	50	111	57	118
405	100	1119	15	50	109	68	137
461	110	1456	16	50	144	116	239
514	115	1828	16	51	146	148	269
572	100	2265	14	50	206	259	400

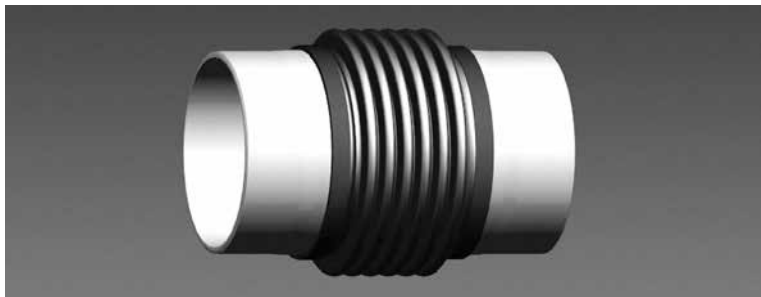
1) Inner sleeve, movement absorption: The inner sleeve is designed for axial movement only.

The movements (axial, angular, lateral) apply to 1000 load changes and are to be regarded as alternativ, i.e. the sum of their proportions in percentages should not exceed 100 %.

2) Available with other hole patterns / thicknesses on request. The overall length L0 may change then.

# AXIAL EXPANSION JOINTS FOR LOW PRESSURE (EXHAUST) WITH WELD ENDS TYPE ARN

06



## Type designation

The type designation consists of 2 parts

1. Type series, defined by 3 letters
2. Nominal size, defined by 10 digits

## Example

Type ARN: HYDRA axial expansion joint with weld ends

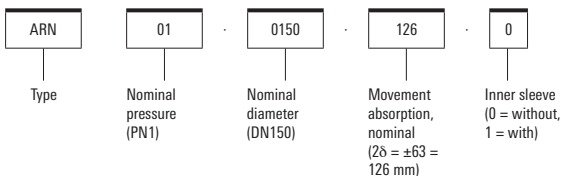
## Standard version/materials:

Multi-ply bellows made of 1.4541

Weld end made of P235TR1 (1.0254) or P265GH (1.0425)

Operating temperature: up to 550 °C

## Type designation (example)



## Order text

Please state the following with your order:

For standard versions

- Type designation or order number

With material variation

- Type designation
- Details of materials

The expansion joints for low pressure (exhaust-gas) are designed for unpressurized applications (PS < 0.5 bar gauge pressure).

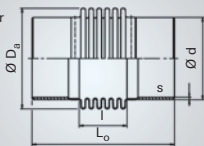
The Pressure Equipment Directive (PED) does not apply to this operating condition.

## Information

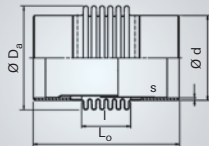
Tell us the dimensions that deviate from the standard and we customize the expansion joint to your specification.

# AXIAL EXPANSION JOINTS FOR LOW PRESSURE WITH WELD ENDS

Type ARN  
without inner  
sleeve



Type ARN  
with inner  
sleeve



06

Nominal diameter	Nominal axial movement absorption <sup>1)</sup>	Type ARN 01...	Order No. standard version		Overall length	Weight approx.		Weld end	
			without inner sleeve	with inner sleeve		without inner sleeve	with inner sleeve	outside diameter	wall thickness
DN	2 $\delta_N$	—	—	—	L <sub>o</sub>	G	G	d	s
—	mm	—	—	—	mm	kg	kg	—	mm
50	24	.0050.024.0	417751	417842	214	1	1.2	60.3	2.9
50	56	.0050.056.0	417753	417843	286	1.2	1.5	60.3	2.9
50	80	.0050.080.0	417754	417844	340	1.4	1.8	60.3	2.9
65	28	.0065.028.0	417755	417845	214	1.5	1.7	76.1	2.9
65	64	.0065.064.0	417756	417846	286	1.8	2.2	76.1	2.9
65	92	.0065.092.0	417757	417847	340	2	2.6	76.1	2.9
80	37	.0080.037.0	417758	417848	230	1.8	2.1	88.9	3.2
80	74	.0080.074.0	417759	417849	300	2.1	2.7	88.9	3.2
80	106	.0080.106.0	417760	417850	360	2.4	3.1	88.9	3.2
100	40	.0100.040.0	417761	417851	226	2.3	2.7	114.3	3.6
100	86	.0100.086.0	417762	417852	303	2.7	3.5	114.3	3.6
100	119	.0100.119.0	417763	417853	358	3.1	4.1	114.3	3.6
125	63	.0125.063.0	417764	417854	251	2.9	3.5	139.7	4
125	126	.0125.126.0	417765	417855	342	3.6	4.7	139.7	4
125	180	.0125.180.0	417766	417856	420	4.1	6	139.7	4
150	63	.0150.063.0	417767	417857	251	3.5	4.2	168.3	4
150	126	.0150.126.0	417768	417858	342	4.3	6	168.3	4
150	180	.0150.180.0	417769	417860	420	5	7	168.3	4
200	70	.0200.070.0	417770	417861	265	4.6	6	219.1	4.5
200	140	.0200.140.0	417771	417862	370	6	8	219.1	4.5
200	200	.0200.200.0	417772	417863	460	7	9	219.1	4.5

# TYPE ARN 01... PN 1

06

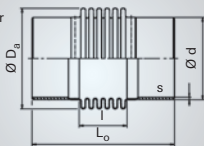
Bellows			Nominal movement absorption <sup>1)</sup>		Vibrations in all planes	Spring rate			Natural frequency of the bellows	
outside diameter	corrugated length	effective cross-section	angular	lateral		axial	angular	lateral	axial	radial
D <sub>s</sub>	l	A	2c <sub>αN</sub>	2λ <sub>N</sub>	â	c <sub>0</sub>	c <sub>α</sub>	c <sub>λ</sub>	ω <sub>a</sub>	ω <sub>r</sub>
mm	mm	cm <sup>2</sup>	degree	mm	mm	N/mm	Nm/deg	N/mm	Hz	Hz
89	54	46	36	5.6	0.5	87	1.1	259	350	1250
89	126	46	78	31	1	37	0.5	20	150	230
89	180	46	102	63	1	26	0.3	7	105	110
107	54	68.7	33	5.3	0.5	85	1.6	378	290	1280
107	126	68.7	73	29	1	36	0.7	30	125	235
107	180	68.7	96	59	1	25	0.5	10	90	115
121	70	89.1	39	8.1	0.5	67	1.7	233	220	840
121	140	89.1	73	33	1	34	0.8	29	110	210
121	200	89.1	96	66	1	24	0.6	9.8	75	105
148	66	137	34	6.6	0.5	73	2.8	432	210	1050
148	143	137	68	31	1	34	1.3	42	100	225
148	198	137	87	59	1	24	0.9	16	70	115
174	91	187	45	12	0.5	41	2.1	177	120	520
174	182	187	83	49	1	21	1.1	23	60	130
174	260	187	103	101	1	14	0.7	7.4	40	65
203	91	264	38	10	1	48	3.5	293	120	610
203	182	264	69	42	1	24	1.8	37	60	150
203	260	264	86	85	1	17	1.2	13	40	75
255	105	432	33	10	1	53	6.4	397	110	600
255	210	432	59	42	1	27	3.2	51	55	150
255	300	432	72	85	1	19	2.3	17	40	75

1) Inner sleeve, movement absorption: The inner sleeve is designed for axial movement only. The movements (axial, angular, lateral) apply to 1000 load changes and are to be regarded as alternativ, i.e. the sum of their proportions in percentages should not exceed 100 %.

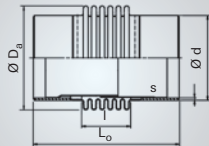


# AXIAL EXPANSION JOINTS FOR LOW PRESSURE WITH WELD ENDS

Type ARN  
without inner  
sleeve



Type ARN  
with inner  
sleeve



06

Nominal diameter	Nominal axial movement absorption <sup>1)</sup>	Type ARN 01...	Order No. standard version		Overall length	Weight approx.		Weld end	
			without inner sleeve	with inner sleeve		without inner sleeve	with inner sleeve	outside diameter	wall thickness
DN	2 $\delta_N$	–	–	–	L <sub>o</sub>	G	G	d	s
–	mm	–	–	–	mm	kg	kg	–	mm
250	72	.0250.072.0	417773	417864	262	6	7	273	5
250	144	.0250.144.0	417774	417865	364	7	9	273	5
250	216	.0250.216.0	417775	417867	466	8	12	273	5
300	70	.0300.070.0	417777	417868	255	7	9	323.9	5.6
300	154	.0300.154.0	417778	417869	369	8	13	323.9	5.6
300	210	.0300.210.0	417779	417870	445	9	15	323.9	5.6
350	75	.0350.075.0	417780	417871	260	7	10	355.6	8
350	150	.0350.150.0	417781	417872	360	9	14	355.6	8
350	210	.0350.210.0	417782	417873	440	10	16	355.6	8
400	65	.0400.065.0	417783	417874	265	10	13	406.4	8.8
400	117	.0400.117.0	417784	417875	349	13	18	406.4	8.8
400	195	.0400.195.0	417785	417876	475	17	25	406.4	8.8
450	56	.0450.056.0	417786	417877	248	11	14	457	4
450	140	.0450.140.0	417787	417878	380	16	22	457	4
450	196	.0450.196.0	417789	417879	468	19	27	457	4
500	68	.0500.068.0	417790	417880	292	14	18	508	4
500	136	.0500.136.0	417791	417881	384	18	25	508	4
500	221	.0500.221.0	417792	417882	499	23	33	508	4
600	76	.0600.076.0	417793	417883	304	17	22	610	4
600	152	.0600.152.0	417794	417884	408	22	32	610	4
600	228	.0600.228.0	417795	417885	512	27	40	610	4

# TYPE ARN 01... PN 1

06

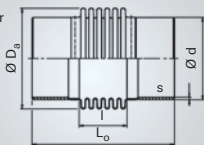
Bellows			Nominal movement absorption <sup>1)</sup>		Vibrations in all planes	Spring rate			Natural frequency of the bellows	
outside diameter	corrugated length	effective cross-section	angular	lateral		axial	angular	lateral	axial	radial
D <sub>s</sub>	l	A	2c <sub>αN</sub>	2λ <sub>N</sub>	â	c <sub>0</sub>	c <sub>α</sub>	c <sub>λ</sub>	ω <sub>a</sub>	ω <sub>r</sub>
mm	mm	cm <sup>2</sup>	degree	mm	mm	N/mm	Nm/deg	N/mm	Hz	Hz
312	102	661	28	8.4	0.7	62	11	752	110	780
312	204	661	50	34	1	31	5.7	94	55	190
312	306	661	64	76	1	21	3.9	28	35	90
365	95	916	23	6.5	0.5	73	19	1415	110	1030
365	209	916	46	31	1	33	8.4	132	50	210
365	285	916	56	58	1	24	6.1	52	40	115
400	100	1104	22	6.7	0.5	66	20	1392	100	950
400	200	1104	41	27	1	33	10	174	50	240
400	280	1104	52	52	1	24	7.4	62	35	120
458	105	1445	17	5.3	0.5	212	85	5283	120	1260
458	189	1445	30	17	1	118	47	904	70	390
458	315	1445	45	48	1	71	29	195	40	140
513	88	1825	13	3.4	0.3	243	123	10935	130	1850
513	220	1825	31	21	1	97	49	698	55	300
513	308	1825	41	42	1	70	35	253	40	150
569	92	2252	14	3.9	0.3	215	135	10875	115	1690
569	184	2252	28	16	1	107	67	1359	55	420
569	299	2252	42	41	1	66	41	318	35	160
674	104	3202	14	4.1	0.3	215	191	12099	100	1570
674	208	3202	26	17	1	107	95	1512	50	390
674	312	3202	36	37	1	72	64	446	35	175

1) Inner sleeve, movement absorption: The inner sleeve is designed for axial movement only.

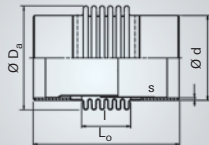
The movements (axial, angular, lateral) apply to 1000 load changes and are to be regarded as alternativ, i.e. the sum of their proportions in percentages should not exceed 100 %.

# AXIAL EXPANSION JOINTS FOR LOW PRESSURE WITH WELD ENDS

Type ARN  
without inner  
sleeve



Type ARN  
with inner  
sleeve



06

Nominal diameter	Nominal axial movement absorption <sup>1)</sup>	Type ARN 01...	Order No. standard version		Overall length	Weight approx.		Weld end	
			without inner sleeve	with inner sleeve		without inner sleeve	with inner sleeve	outside diameter	wall thickness
DN	2 <sub>N</sub>	–	–	–	L <sub>o</sub>	G	G	d	s
–	mm	–	–	–	mm	kg	kg	–	mm
700	80	.0700.080.0	417796	417886	312	21	27	711	4
700	140	.0700.140.0	417797	417887	396	26	36	711	4
700	220	.0700.220.0	417798	417888	508	32	46	711	4
800	84	.0800.084.0	417799	417889	316	24	33	813	4
800	147	.0800.147.0	417800	417890	403	29	42	813	4
800	231	.0800.231.0	417801	417891	519	37	54	813	4
900	84	.0900.084.0	417802	417892	320	27	38	914	4
900	168	.0900.168.0	417805	417893	440	36	52	914	4
900	231	.0900.231.0	417807	417894	530	43	62	914	4
1000	72	.1000.072.0	417808	417895	296	28	36	1016	4
1000	144	.1000.144.0	417809	417896	392	35	51	1016	4
1000	240	.1000.240.0	417811	417898	520	45	67	1016	4
1200	72	.1200.072.0	417812	417899	293	34	46	1220	4
1200	144	.1200.144.0	417813	417900	386	43	67	1220	4
1200	240	.1200.240.0	417814	417901	510	55	89	1220	4
1400	48	.1400.048.0	417815	417902	304	39	53	1420	4
1400	108	.1400.108.0	417816	417903	434	51	80	1420	4
1400	180	.1400.180.0	417817	417904	590	65	109	1420	4
1600	48	.1600.048.0	417818	417905	304	44	61	1620	4
1600	108	.1600.108.0	417819	417906	434	58	92	1620	4
1600	180	.1600.180.0	417820	417907	590	75	124	1620	4

# TYPE ARN 01... PN 1

06

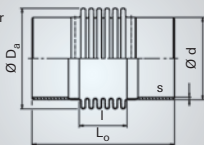
Bellows			Nominal movement absorption <sup>1)</sup>		Vibrations in all planes	Spring rate			Natural frequency of the bellows	
outside diameter	corrugated length	effective cross-section	angular	lateral		axial	angular	lateral	axial	radial
D <sub>s</sub>	l	A	2c <sub>αN</sub>	2λ <sub>N</sub>	â	c <sub>0</sub>	c <sub>α</sub>	c <sub>λ</sub>	ω <sub>a</sub>	ω <sub>r</sub>
mm	mm	cm <sup>2</sup>	degree	mm	mm	N/mm	Nm/deg	N/mm	Hz	Hz
780	112	4324	12	4	0.3	203	244	13365	90	1480
780	196	4324	21	12	1	116	139	2494	50	480
780	308	4324	30	30	1	74	89	644	30	195
882	116	5588	11	3.9	0.3	220	341	17449	85	1570
882	203	5588	19	12	1	126	196	3263	50	510
882	319	5588	28	29	1	80	124	839	30	210
992	120	7133	9.9	3.5	0.2	238	472	22421	80	1650
992	240	7133	19	14	1	119	236	2815	40	410
992	330	7133	25	27	1	86	170	1076	30	220
1095	96	8750	7.7	2.2	0.2	335	814	60745	105	2940
1095	192	8750	15	8.7	0.7	168	408	7570	50	740
1095	320	8750	23	24	1	101	245	1632	30	265
1295	93	12331	6.5	1.8	0.1	331	1134	89855	95	3210
1295	186	12331	13	7.1	0.6	165	565	11232	45	800
1295	310	12331	20	20	1	99	339	2426	30	290
1472	104	16377	3.8	1.2	0.1	932	4190	266329	150	5320
1472	234	16377	8.3	5.8	0.5	414	1865	23362	70	1050
1472	390	16377	13	16	1	249	1119	5038	40	380
1672	104	21227	3.3	1	0.1	1056	6168	391692	150	6040
1672	234	21227	7.3	5.1	0.5	470	2742	34354	70	1200
1672	390	21227	12	14	1	282	1645	7437	40	430

1) Inner sleeve, movement absorption: The inner sleeve is designed for axial movement only.

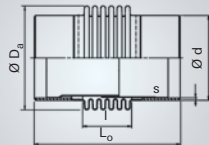
The movements (axial, angular, lateral) apply to 1000 load changes and are to be regarded as alternativ, i.e. the sum of their proportions in percentages should not exceed 100 %.

# AXIAL EXPANSION JOINTS FOR LOW PRESSURE WITH WELD ENDS

Type ARN  
without inner  
sleeve



Type ARN  
with inner  
sleeve



06

Nominal diameter	Nominal axial movement absorption <sup>1)</sup>	Type ARN 01...	Order No. standard version		Overall length	Weight approx.		Weld end	
			without inner sleeve	with inner sleeve		without inner sleeve	with inner sleeve	outside diameter	wall thickness
DN	2 <sub>N</sub>	–	–	–	L <sub>o</sub>	G	G	d	s
–	mm	–	–	–	mm	kg	kg	–	mm
1800	48	.1800.048.0	417821	417908	304	49	68	1820	4
1800	108	.1800.108.0	417822	417909	434	65	103	1820	4
1800	180	.1800.180.0	417823	417910	590	84	140	1820	4
2000	48	.2000.048.0	417824	417911	304	55	76	2020	4
2000	108	.2000.108.0	417825	417912	434	72	115	2020	4
2000	180	.2000.180.0	417826	417913	590	93	155	2020	4
2200	48	.2200.048.0	417827	417914	304	82	105	2220	4
2200	108	.2200.108.0	417828	417915	434	101	149	2220	4
2200	180	.2200.180.0	417829	417917	590	124	194	2220	4
2400	48	.2400.048.0	417830	417918	304	89	114	2420	4
2400	108	.2400.108.0	417831	417919	434	110	163	2420	4
2400	180	.2400.180.0	417832	417920	590	135	211	2420	4
2600	48	.2600.048.0	417833	417921	304	97	124	2620	4
2600	108	.2600.108.0	417834	417922	434	119	176	2620	4
2600	180	.2600.180.0	417835	417923	590	146	228	2620	4
2800	48	.2800.048.0	417836	417924	304	104	133	2820	4
2800	108	.2800.108.0	417837	417926	434	128	190	2820	4
2800	180	.2800.180.0	417838	417927	590	158	246	2820	4
3000	48	.3000.048.0	417839	417928	304	112	143	3020	4
3000	108	.3000.108.0	417840	417929	434	137	203	3020	4
3000	180	.3000.180.0	417841	417930	590	169	264	3020	4

# TYPE ARN 01... PN 1

06

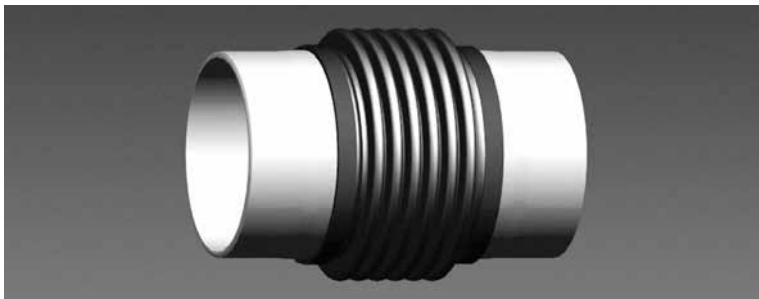
Bellows			Nominal movement absorption <sup>1)</sup>		Vibrations in all planes	Spring rate			Natural frequency of the bellows	
outside diameter	corrugated length	effective cross-section	angular	lateral		axial	angular	lateral	axial	radial
D <sub>s</sub>	l	A	2c <sub>αN</sub>	2λ <sub>N</sub>	â	c <sub>0</sub>	c <sub>α</sub>	c <sub>λ</sub>	ω <sub>a</sub>	ω <sub>r</sub>
mm	mm	cm <sup>2</sup>	degree	mm	mm	N/mm	Nm/deg	N/mm	Hz	Hz
1872	104	26706	3	0.9	0	1180	8672	550794	150	6760
1872	234	26706	6.6	4.6	0.4	524	3858	48345	70	1340
1872	390	26706	10	13	1	315	2315	10463	40	480
2072	104	32813	2.7	0.8	0	1302	11767	747440	150	7480
2072	234	32813	5.9	4.1	0.4	579	5232	65695	70	1480
2072	390	32813	9.5	11	1	347	3136	14174	40	530
2272	104	39549	2.5	0.7	0	1424	15523	986064	150	8200
2272	234	39549	5.4	3.8	0.3	633	6899	86629	70	1620
2272	390	39549	8.8	10	1	380	4142	18722	40	580
2472	104	46913	2.3	0.7	0	1545	20003	1270727	150	8900
2472	234	46913	5	3.4	0.3	687	8887	111595	70	1760
2472	390	46913	8	9.6	1	412	5330	24093	40	630
2672	104	54905	2.1	0.6	0	1667	25256	1604521	150	9620
2672	234	54905	4.6	3.2	0.3	741	11225	140948	70	1900
2672	390	54905	7.4	8.9	0.8	444	6741	30403	40	680
2872	104	63526	1.9	0.6	0	1788	31375	1993293	150	10330
2872	234	63526	4.3	3	0.2	795	13940	175043	65	2040
2872	390	63526	7	8.2	0.8	477	8364	37809	40	740
3072	104	72774	1.8	0.5	0	1909	38389	2438990	150	11050
3072	234	72774	4	2.8	0.2	849	17062	213982	65	2180
3072	390	72774	6.5	7.7	0.7	509	10229	46238	40	790

1) Inner sleeve, movement absorption: The inner sleeve is designed for axial movement only.

The movements (axial, angular, lateral) apply to 1000 load changes and are to be regarded as alternativ, i.e. the sum of their proportions in percentages should not exceed 100 %.

# AXIAL EXPANSION JOINTS WITH WELD ENDS TYPE ARN

06



## Type designation

The type designation consists of 2 parts

1. Type series, defined by 3 letters
2. Nominal size, defined by 10 digits

## Example

Type ARN: HYDRA axial expansion joint with weld ends

## Standard version/materials:

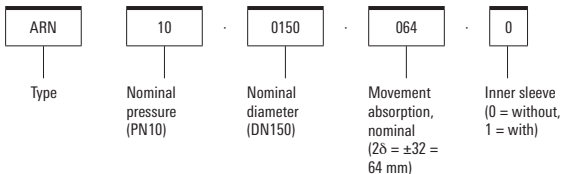
Multi-ply bellows made of 1.4541

Weld ends up to DN 300: P235GH (1.0345)

Weld ends from DN 350: P265GH (1.0425)

Operating temperature: up to 400 °C

## Type designation (example)



## Order text according to guideline 2014/68/EU "Pressure Equipment Directive"

Please state the following with your order:

For standard versions

- Type designation or order number

With material variation

- Type designation
- Details of the materials

According to the Pressure Equipment Directive, the following information is required for testing and documentation:

06

Type of pressure equipment according to Art. 1 & 2:

- Vessel - volume V [l] \_\_\_\_\_
- Piping - nominal diameter DN \_\_\_\_\_

Medium property according to Art. 13:

- Group 1 – dangerous
- Group 2 – all other fluids

State of medium

- Gaseous or liquid if PD > 0.5 bar
- Liquid if PD ≤ 0.5 bar

Design data:

- Max. allowable pressure [bar] \_\_\_\_\_
- Max./min. allowable temperature [°C] \_\_\_\_\_
- Test pressure PT [bar] \_\_\_\_\_

Optional:

- Category \_\_\_\_\_

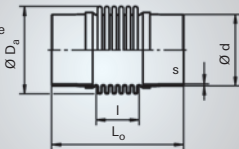
### Note

Tell us the dimensions that deviate from the standard and we customize the expansion joint to your specification.

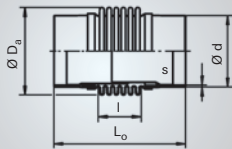


# AXIAL EXPANSION JOINTS WITH WELD ENDS

Type ARN  
without  
inner sleeve



Type ARN  
with inner  
sleeve



06

Nominal diameter	Nominal axial movement absorption <sup>1)</sup>	Type ARN 02...	Order No. standard version		Overall length	Weight approx.		Weld end	
			without inner sleeve	with inner sleeve		without inner sleeve	with inner sleeve	outside diameter	wall thickness
DN	2 $\delta_N$	-	-	-	L <sub>o</sub>	G	G	d	s
-	mm	-	-	-	mm	kg	kg	-	mm
50	24	.0050.024.0	417017	417122	214	1	1,2	60,3	2,9
50	44	.0050.044.0	417023	417123	259	1,1	1,3	60,3	2,9
50	70	.0050.070.0	417024	417124	331	1,7	2,1	60,3	2,9
65	28	.0065.028.0	417042	417125	214	1,5	1,7	76,1	2,9
65	60	.0065.060.0	417043	417126	277	1,7	2	76,1	2,9
65	87	.0065.087.0	417044	417127	350	2,4	3	76,1	2,9
80	27	.0080.027.0	417046	417128	210	1,7	2	88,9	3,2
80	64	.0080.064.0	417045	417129	280	2	2,4	88,9	3,2
80	92	.0080.092.0	417047	417130	358	2,7	3,4	88,9	3,2
100	46	.0100.046.0	417048	417131	237	2,3	2,7	114,3	3,6
100	86	.0100.086.0	417049	417132	303	2,7	3,5	114,3	3,6
100	122	.0100.122.0	417050	417133	420	5	7	114,3	3,6
125	45	.0125.045.0	417051	417134	241	2,7	3,2	139,7	4
125	90	.0125.090.0	417052	417135	306	3,2	4,2	139,7	4
125	140	.0125.140.0	417053	417136	456	7	8	139,7	4
150	54	.0150.054.0	417054	417137	254	3,6	4,3	168,3	4
150	99	.0150.099.0	417055	417138	319	4,1	5	168,3	4
150	160	.0150.160.0	417056	417139	476	9	11	168,3	4
200	70	.0200.070.0	417057	417140	285	6	8	219,1	4,5
200	130	.0200.130.0	417058	417141	388	9	11	219,1	4,5
200	190	.0200.190.0	417059	417142	503	13	16	219,1	4,5

# TYPE ARN 02...

## PN 2.5

06

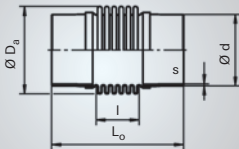
Bellows			Nominal movement absorption <sup>1)</sup>		Spring rate		
outside diameter	corrugated length	effective cross-section	angular	lateral	axial	angular	lateral
D <sub>s</sub>	l	A	2α <sub>N</sub>	2λ <sub>N</sub>	c <sub>0</sub>	c <sub>α</sub>	c <sub>λ</sub>
mm	mm	cm <sup>2</sup>	degree	mm	N/mm	Nm/deg	N/mm
89	54	46	35	5,6	86	1,1	259
89	99	46	59	19	47	0,6	42
89	171	46	86	52	45	0,6	14
107	54	68,7	33	5,3	84	1,6	378
107	117	68,7	62	25	39	0,7	37
108	190	69,4	81	59	39	0,8	14
121	50	89,1	28	4,1	94	2,3	640
121	120	89,1	58	24	39	1	46
121	198	89,1	76	57	42	1	18
148	77	137	37	9	62	2,4	273
148	143	137	59	31	33	1,3	42
150	260	139	81	79	56	2,2	22
174	65	187	31	6,3	58	3	492
174	130	187	52	25	29	1,5	61
172	280	185	77	85	52	2,7	23
203	78	264	31	7,7	56	4,1	465
203	143	264	48	26	31	2,3	77
203	300	264	72	87	51	3,7	29
255	105	432	31	10	53	6,4	397
256	208	434	48	38	42	5,1	80
257	323	436	65	87	51	6,2	41

1) Inner sleeve, movement absorption: The inner sleeve is designed for axial movement only.

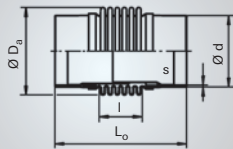
The movements (axial, angular, lateral) apply to 1000 load changes and are to be regarded as alternativ, i.e. the sum of their proportions in percentages should not exceed 100 %.

# AXIAL EXPANSION JOINTS WITH WELD ENDS

Type ARN  
without  
inner  
sleeve



Type ARN  
with inner  
sleeve



Nominal diameter	Nominal axial movement absorption <sup>1)</sup>	Type ARN 02...	Order No. standard version		Overall length	Weight approx.		Weld end	
			without inner sleeve	with inner sleeve		without inner sleeve	with inner sleeve	outside diameter	wall thickness
DN	$2\varnothing_N$	—	—	—	$L_o$	G	G	d	s
—	mm	—	—	—	mm	kg	kg	—	mm
250	72	.0250.072.0	417062	417143	282	9	11	273	5
250	144	.0250.144.0	417063	417144	384	12	14	273	5
250	204	.0250.204.0	417064	417145	486	17	21	273	5
300	70	.0300.070.0	417065	417146	279	12	14	323.9	5,6
300	126	.0300.126.0	417066	417147	355	13	17	323.9	5,6
300	210	.0300.210.0	417067	417148	464	21	26	323.9	5,6
350	75	.0350.075.0	417068	417149	284	10	13	355.6	8
350	150	.0350.150.0	417069	417150	384	13	18	355.6	8
350	210	.0350.210.0	417070	417151	478	20	26	355.6	8
400	65	.0400.065.0	417071	417152	289	13	16	406.4	8,8
400	117	.0400.117.0	417072	417153	373	16	21	406.4	8,8
400	195	.0400.195.0	417073	417154	499	20	28	406.4	8,8
450	56	.0450.056.0	417074	417155	272	14	18	457	4
450	140	.0450.140.0	417075	417156	404	19	26	457	4
450	196	.0450.196.0	417076	417157	492	23	31	457	4
500	68	.0500.068.0	417089	417158	320	19	23	508	4
500	136	.0500.136.0	417090	417159	412	23	31	508	4
500	221	.0500.221.0	417091	417160	527	28	39	508	4
600	76	.0600.076.0	417092	417161	332	23	29	610	4
600	152	.0600.152.0	417093	417162	436	28	38	610	4
600	228	.0600.228.0	417094	417163	540	33	47	610	4

# TYPE ARN 02...

## PN 2.5

06

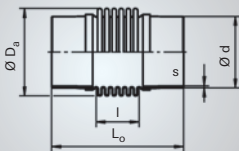
Bellows			Nominal movement absorption <sup>1)</sup>		Spring rate		
outside diameter	corrugated length	effective cross-section	angular	lateral	axial	angular	lateral
D <sub>s</sub>	l	A	2α <sub>N</sub>	2λ <sub>N</sub>	c <sub>0</sub>	c <sub>α</sub>	c <sub>λ</sub>
mm	mm	cm <sup>2</sup>	degree	mm	N/mm	Nm/deg	N/mm
312	102	661	27	8.4	62	11	752
315	204	667	47	34	40	7.4	123
316	306	670	64	71	49	9.1	67
365	95	916	22	6.5	73	19	1415
365	171	916	36	21	40	10	239
371	280	932	59	57	52	13	118
400	100	1104	22	6.7	66	20	1392
402	200	1110	39	27	46	14	244
402	294	1110	54	55	60	19	147
458	105	1445	17	5.3	211	85	5283
458	189	1445	28	17	117	47	904
458	315	1445	39	48	70	28	195
513	88	1825	13	3.4	243	123	10935
513	220	1825	29	21	97	49	698
513	308	1825	36	42	69	35	253
569	92	2252	14	3.9	214	134	10875
569	184	2252	26	16	107	67	1359
569	299	2252	37	41	66	41	318
674	104	3202	13	4.1	214	190	12099
674	208	3202	25	17	107	95	1512
674	312	3202	32	37	71	63	446

1) Inner sleeve, movement absorption: The inner sleeve is designed for axial movement only.

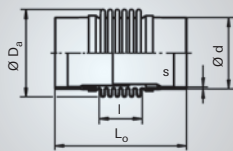
The movements (axial, angular, lateral) apply to 1000 load changes and are to be regarded as alternativ, i.e. the sum of their proportions in percentages should not exceed 100 %.

# AXIAL EXPANSION JOINTS WITH WELD ENDS

Type ARN  
without  
inner  
sleeve



Type ARN  
with inner  
sleeve



Nominal diameter	Nominal axial movement absorption <sup>1)</sup>	Type ARN 02...	Order No. standard version		Overall length	Weight approx.		Weld end	
			without inner sleeve	with inner sleeve		without inner sleeve	with inner sleeve	outside diameter	wall thickness
DN	$2\varnothing_N$	—	—	—	$L_o$	G	G	d	s
—	mm	—	—	—	mm	kg	kg	—	mm
700	80	.0700.080.0	417095	417164	340	28	34	711	4
700	140	.0700.140.0	417096	417165	424	33	44	711	4
700	220	.0700.220.0	417097	417166	536	39	54	711	4
800	84	.0800.084.0	417098	417167	348	32	42	813	4
800	147	.0800.147.0	417099	417168	435	37	51	813	4
800	231	.0800.231.0	417100	417169	551	45	63	813	4
900	84	.0900.084.0	417101	417170	352	36	48	914	4
900	168	.0900.168.0	417102	417171	472	45	62	914	4
900	231	.0900.231.0	417103	417172	562	51	72	914	4
1000	72	.1000.072.0	417104	417173	332	38	47	1016	4
1000	144	.1000.144.0	417105	417175	428	45	62	1016	4
1000	240	.1000.240.0	417106	417174	556	55	78	1016	4
1200	72	.1200.072.0	417107	417176	332	62	77	1220	4
1200	144	.1200.144.0	417108	417177	428	76	102	1220	4
1200	240	.1200.240.0	417109	417178	556	94	131	1220	4
1400	48	.1400.048.0	417110	417179	304	66	81	1420	4
1400	108	.1400.108.0	417111	417181	434	78	108	1420	4
1400	180	.1400.180.0	417112	417182	590	93	136	1420	4
1600	48	.1600.048.0	417113	417183	304	76	92	1620	4
1600	108	.1600.108.0	417114	417184	434	89	123	1620	4
1600	180	.1600.180.0	417115	417185	590	106	156	1620	4

# TYPE ARN 02...

## PN 2.5

06

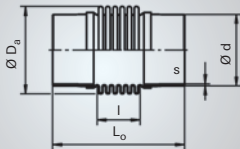
Bellows			Nominal movement absorption <sup>1)</sup>		Spring rate		
outside diameter	corrugated length	effective cross-section	angular	lateral	axial	angular	lateral
D <sub>s</sub>	l	A	2c <sub>αN</sub>	2λ <sub>Nl</sub>	c <sub>0</sub>	c <sub>α</sub>	c <sub>λ</sub>
mm	mm	cm <sup>2</sup>	degree	mm	N/mm	Nm/deg	N/mm
780	112	4324	12	4	203	244	13365
780	196	4324	20	12	116	139	2494
780	308	4324	27	30	74	89	644
882	116	5588	11	3.9	220	341	17449
882	203	5588	18	12	126	196	3263
882	319	5588	25	29	80	124	839
992	120	7133	9.8	3.5	237	470	22421
992	240	7133	18	14	119	236	2815
992	330	7133	22	27	86	170	1076
1095	96	8750	7.7	2.2	335	814	60745
1095	192	8750	14	8.7	167	406	7570
1095	320	8750	21	24	100	243	1632
1295	96	12331	6.5	1.8	511	1750	130579
1295	192	12331	13	7.4	255	873	16290
1295	320	12331	19	20	153	524	3519
1472	104	16377	3.8	1.2	921	4190	266329
1472	234	16377	8.1	5.8	409	1861	23362
1472	390	16377	12	16	245	1115	5038
1672	104	21227	3.3	1	1045	6162	391692
1672	234	21227	7.2	5.1	464	2736	34354
1672	390	21227	11	14	279	1645	7437

1) Inner sleeve, movement absorption: The inner sleeve is designed for axial movement only.

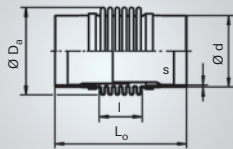
The movements (axial, angular, lateral) apply to 1000 load changes and are to be regarded as alternativ, i.e. the sum of their proportions in percentages should not exceed 100 %.

# AXIAL EXPANSION JOINTS WITH WELD ENDS

Type ARN  
without  
inner  
sleeve



Type ARN  
with inner  
sleeve



06

Nom- inal dia- meter	Nominal axial movement absorption <sup>1</sup>	Type  ARN 02...	Order No. standard version		Overall length	Weight approx.		Weld end	
			without inner sleeve	with inner sleeve		without inner sleeve	with inner sleeve	outside diameter	wall thickness
DN	2 $\delta_N$	–	–	–	L <sub>o</sub>	G	G	d	s
–	mm	–	–	–	mm	kg	kg	–	mm
1800	48	.1800.048.0	417116	417186	304	85	103	1820	4
1800	108	.1800.108.0	417117	417187	434	100	139	1820	4
1800	180	.1800.180.0	417118	417188	590	119	175	1820	4
2000	48	.2000.048.0	417119	417189	304	94	115	2020	4
2000	108	.2000.108.0	417120	417190	434	111	154	2020	4
2000	180	.2000.180.0	417121	417191	590	132	194	2020	4

# TYPE ARN 02...

## PN 2.5

06

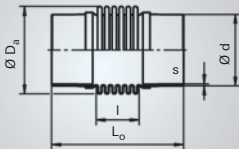
Bellows			Nominal movement absorption <sup>1)</sup>		Spring rate		
outside diameter	corrugated length	effective cross-section	angular	lateral	axial	angular	lateral
$D_s$	$l$	$A$	$2c_{\alpha N}$	$2c_{\lambda N}$	$c_0$	$c_{\alpha}$	$c_{\lambda}$
mm	mm	cm <sup>2</sup>	degree	mm	N/mm	Nm/deg	N/mm
1872	104	26706	3	0.9	1168	8665	550794
1872	234	26706	6.4	4.6	519	3850	48345
1872	390	26706	9.8	13	312	2315	10463
2072	104	32813	2.7	0.8	1290	11758	747440
2072	234	32813	5.8	4.1	574	5232	65695
2072	390	32813	9	11	344	3136	14174

1) Inner sleeve, movement absorption: The inner sleeve is designed for axial movement only. The movements (axial, angular, lateral) apply to 1000 load changes and are to be regarded as alternativ, i.e. the sum of their proportions in percentages should not exceed 100 %.

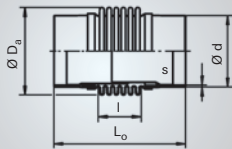


# AXIAL EXPANSION JOINTS WITH WELD ENDS

Type ARN  
without  
inner  
sleeve



Type ARN  
with inner  
sleeve



06

Nominal diameter	Nominal axial movement absorption <sup>1</sup>	Type ARN 06...	Order No. standard version		Overall length	Weight approx.		Weld end	
			without inner sleeve	with inner sleeve		without inner sleeve	with inner sleeve	outside diameter	wall thickness
DN	$2\delta_N$	–	–	–	$L_o$	G	G	d	s
–	mm	–	–	–	mm	kg	kg	–	mm
50	24	.0050.024.0	417283	417402	214	1	1	60.3	2.9
50	52	.0050.052.0	417284	417403	286	1.4	1.7	60.3	2.9
65	28	.0065.028.0	417286	417404	214	1.5	1.7	76.1	2.9
65	46	.0065.046.0	417298	417405	250	1.6	1.9	76.1	2.9
65	72	.0065.072.0	417299	417406	358	3.6	4.2	76.1	2.9
80	27	.0080.027.0	417300	417407	210	1.7	2	88.9	3.2
80	48	.0080.048.0	417301	417408	250	1.9	2.2	88.9	3.2
80	77	.0080.077.0	417302	417409	364	4	4.7	88.9	3.2
100	33	.0100.033.0	417303	417410	215	2.2	2.6	114.3	3.6
100	59	.0100.059.0	417304	417411	268	2.8	3.3	114.3	3.6
100	93	.0100.093.0	417305	417412	368	5	6	114.3	3.6
125	36	.0125.036.0	417306	417413	228	2.6	3.1	139.7	4
125	63	.0125.063.0	417307	417414	267	2.9	3.6	139.7	4
125	98	.0125.098.0	417308	417415	386	6	7	139.7	4
150	40	.0150.040.0	417309	417416	246	3.7	4.4	168.3	4
150	88	.0150.088.0	417310	417417	341	6	8	168.3	4
150	124	.0150.124.0	417311	417418	448	11	13	168.3	4
200	40	.0200.040.0	417312	417419	244	6	7	219.1	4.5
200	90	.0200.090.0	417313	417420	333	9	11	219.1	4.5
200	140	.0200.140.0	417314	417422	432	15	18	219.1	4.5

# TYPE ARN 06... PN 6

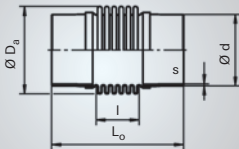
06

Bellows			Nominal movement absorption <sup>1)</sup>		Spring rate		
outside diameter	corrugated length	effective cross-section	angular	lateral	axial	angular	lateral
D <sub>s</sub>	l	A	2c <sub>αN</sub>	2λ <sub>N</sub>	c <sub>0</sub>	c <sub>α</sub>	c <sub>λ</sub>
mm	mm	cm <sup>2</sup>	degree	mm	N/mm	Nm/deg	N/mm
89	54	46	33	5.6	86	1.1	259
89	126	46	57	28	61	0.8	34
107	54	68.7	31	5.3	84	1.6	378
107	90	68.7	44	15	50	1	81
110	198	70.9	65	50	88	1.7	30
121	50	89.1	27	4.1	94	2.3	640
121	90	89.1	41	13	52	1.3	109
123	204	90.8	61	48	95	2.4	40
148	55	137	27	4.6	87	3.3	752
149	108	138	43	16	71	2.7	160
151	208	140	59	48	84	3.3	52
174	52	187	25	4	72	3.7	953
174	91	187	39	12	41	2.1	177
173	210	186	55	45	88	4.6	71
202	70	263	23	5.1	116	8.5	1189
203	165	264	45	26	92	6.8	171
205	272	267	56	61	102	7.6	70
256	64	434	19	3.6	138	17	2791
257	153	436	37	19	107	13	380
260	252	441	52	50	109	13	145

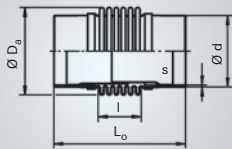
1) Inner sleeve, movement absorption: The inner sleeve is designed for axial movement only.  
The movements (axial, angular, lateral) apply to 1000 load changes and are to be regarded as alternativ, i.e. the sum of their proportions in percentages should not exceed 100 %.

# AXIAL EXPANSION JOINTS WITH WELD ENDS

Type ARN  
without  
inner  
sleeve



Type ARN  
with inner  
sleeve



Nominal diameter	Nominal axial movement absorption <sup>1</sup>	Type ARN 06...	Order No. standard version		Overall length	Weight approx.		Weld end	
			without inner sleeve	with inner sleeve		without inner sleeve	with inner sleeve	outside diameter	wall thickness
DN	2 $\delta_N$	-	-	-	L <sub>o</sub>	G	G	d	s
-	mm	-	-	-	mm	kg	kg	-	mm
250	48	.0250.048.0	417315	417423	252	10	11	273	5
250	96	.0250.096.0	417316	417424	324	12	14	273	5
250	144	.0250.144.0	417317	417425	420	19	22	273	5
300	60	.0300.060.0	417318	417426	264	13	16	323.9	5.6
300	120	.0300.120.0	417319	417427	344	16	20	323.9	5.6
300	165	.0300.165.0	417320	417428	426	24	29	323.9	5.6
350	60	.0350.060.0	417321	417429	268	12	14	355.6	8
350	120	.0350.120.0	417322	417430	352	15	20	355.6	8
350	165	.0350.165.0	417331	417431	437	24	29	355.6	8
400	52	.0400.052.0	417333	417432	272	14	17	406.4	8.8
400	117	.0400.117.0	417334	417433	382	19	25	406.4	8.8
400	169	.0400.169.0	417335	417434	483	29	36	406.4	8.8
450	56	.0450.056.0	417336	417435	276	16	19	457	4
450	112	.0450.112.0	417337	417436	368	21	27	457	4
450	182	.0450.182.0	417338	417437	496	33	42	457	4
500	66	.0500.066.0	417339	417438	328	24	28	508	4
500	149	.0500.149.0	417340	417439	453	34	42	508	4
500	215	.0500.215.0	417341	417440	579	56	68	508	4
600	76	.0600.076.0	417342	417441	340	29	35	610	4
600	133	.0600.133.0	417343	417442	424	37	47	610	4
600	216	.0600.216.0	417344	417443	576	66	80	610	4

# TYPE ARN 06...

## PN 6

06

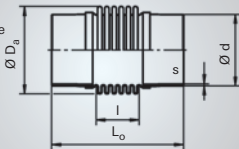
Bellows			Nominal movement absorption <sup>1)</sup>		Spring rate		
outside diameter	corrugated length	effective cross-section	angular	lateral	axial	angular	lateral
D <sub>s</sub>	l	A	2α <sub>N</sub>	2λ <sub>N</sub>	c <sub>0</sub>	c <sub>α</sub>	c <sub>λ</sub>
mm	mm	cm <sup>2</sup>	degree	mm	N/mm	Nm/deg	N/mm
316	72	670	18	3.9	209	39	5156
316	144	670	32	16	105	20	648
319	240	677	45	39	109	20	245
371	80	932	19	4.6	182	47	5062
371	160	932	34	19	91	24	633
374	242	940	44	38	104	27	319
402	84	1110	18	4.5	210	65	6311
402	168	1110	31	18	105	32	789
405	253	1119	40	37	119	37	397
461	88	1456	13	3.5	359	145	12887
461	198	1456	25	18	160	65	1135
462	299	1459	32	39	148	60	461
514	92	1828	13	3.6	364	185	15018
514	184	1828	22	14	182	92	1877
515	312	1832	30	39	150	76	539
572	100	2265	14	4.1	411	259	17778
572	225	2265	26	21	183	115	1564
574	351	2273	35	47	191	121	673
677	112	3217	13	4.4	412	368	20180
677	196	3217	21	14	236	211	3774
678	348	3222	30	39	215	192	1092

1) Inner sleeve, movement absorption: The inner sleeve is designed for axial movement only.

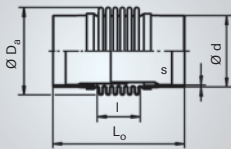
The movements (axial, angular, lateral) apply to 1000 load changes and are to be regarded as alternativ, i.e. the sum of their proportions in percentages should not exceed 100 %.

# AXIAL EXPANSION JOINTS WITH WELD ENDS

Type ARN  
without  
inner sleeve



Type ARN  
with inner  
sleeve



06

Nominal diameter	Nominal axial movement absorption <sup>1</sup>	Type ARN 06...	Order No. standard version		Overall length	Weight approx.		Weld end	
			without inner sleeve	with inner sleeve		without inner sleeve	with inner sleeve	outside diameter	wall thickness
DN	2 <sub>N</sub>	-	-	-	L <sub>0</sub>	G	G	d	s
-	mm	-	-	-	mm	kg	kg	-	mm
700	80	.0700.080.0	417345	417444	340	41	48	711	4
700	140	.0700.140.0	417388	417445	424	51	62	711	4
700	220	.0700.220.0	417389	417446	558	82	98	711	4
800	84	.0800.084.0	417390	417447	364	57	67	813	4
800	168	.0800.168.0	417391	417448	496	80	96	813	4
800	231	.0800.231.0	417392	417449	595	97	117	813	4
900	84	.0900.084.0	417393	417450	364	64	76	914	4
900	168	.0900.168.0	417394	417451	496	91	109	914	4
900	231	.0900.231.0	417395	417452	595	111	133	914	4
1000	66	.1000.066.0	417396	417453	341	64	74	1016	4
1000	132	.1000.132.0	417397	417454	446	87	104	1016	4
1000	220	.1000.220.0	417398	417455	586	117	141	1016	4
1200	69	.1200.069.0	417399	417456	341	89	104	1220	5
1200	138	.1200.138.0	417400	417457	446	116	144	1220	5
1200	230	.1200.230.0	417401	417458	586	153	191	1220	5

# TYPE ARN 06...

## PN 6

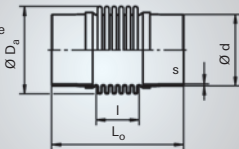
06

Bellows			Nominal movement absorption <sup>1)</sup>		Spring rate		
outside diameter	corrugated length	effective cross-section	angular	lateral	axial	angular	lateral
D <sub>s</sub>	l	A	2α <sub>N</sub>	2λ <sub>N</sub>	c <sub>0</sub>	c <sub>α</sub>	c <sub>λ</sub>
mm	mm	cm <sup>2</sup>	degree	mm	N/mm	Nm/deg	N/mm
780	112	4324	12	4	437	525	28770
780	196	4324	19	12	250	300	5374
783	330	4342	27	33	230	277	1751
887	132	5621	11	4.4	639	998	39372
887	264	5621	20	17	319	498	4914
887	363	5621	24	33	232	362	1890
996	132	7163	9.8	3.9	712	1417	55902
996	264	7163	18	15	356	708	6988
996	363	7163	21	29	259	515	2689
1100	105	8791	7	2.2	970	2369	147726
1100	210	8791	13	8.7	485	1184	18466
1100	350	8791	19	24	291	711	3989
1296	105	12341	6.2	1.9	1088	3730	232590
1296	210	12341	12	7.7	544	1865	29074
1296	350	12341	17	21	327	1121	6291

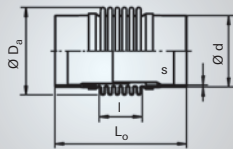
1) Inner sleeve, movement absorption: The inner sleeve is designed for axial movement only. The movements (axial, angular, lateral) apply to 1000 load changes and are to be regarded as alternativ, i.e. the sum of their proportions in percentages should not exceed 100 %.

# AXIAL EXPANSION JOINTS WITH WELD ENDS

Type ARN  
without  
inner sleeve



Type ARN  
with inner  
sleeve



Nominal diameter	Nominal axial movement absorption <sup>1</sup>	Type ARN 10...	Order No. standard version		Overall length	Weight approx.		Weld end	
			without inner sleeve	with inner sleeve		without inner sleeve	with inner sleeve	outside diameter	wall thickness
DN	$2\delta_N$	—	—	—	$L_0$	G	G	d	s
—	mm	—	—	—	mm	kg	kg	—	mm
50	24	.0050.024.0	417459	417506	214	1	1	60.3	2.9
50	46	.0050.046.0	417460	417507	300	1.9	2.2	60.3	2.9
65	23	.0065.023.0	417461	417508	205	1.4	1.6	76.1	2.9
65	37	.0065.037.0	417462	417509	232	1.5	1.8	76.1	2.9
65	60	.0065.060.0	417463	417510	325	3.2	3.6	76.1	2.9
80	20	.0080.020.0	417464	417511	204	1.7	1.9	88.9	3.2
80	41	.0080.041.0	417465	417512	248	2	2.3	88.9	3.2
80	63	.0080.063.0	417466	417513	328	3.6	4.1	88.9	3.2
100	26	.0100.026.0	417467	417514	208	2.3	2.6	114.3	3.6
100	53	.0100.053.0	417468	417515	256	2.7	3.2	114.3	3.6
100	80	.0100.080.0	417469	417516	370	6	7	114.3	3.6
125	30	.0125.030.0	417470	417517	232	2.8	3.3	139.7	4
125	53	.0125.053.0	417471	417518	274	3.2	3.9	139.7	4
125	85	.0125.085.0	417472	417519	384	7	8	139.7	4
150	32	.0150.032.0	417473	417520	236	4.1	4.7	168.3	4
150	64	.0150.064.0	417474	417521	296	5	6	168.3	4
150	95	.0150.095.0	417475	417522	384	9	11	168.3	4
200	40	.0200.040.0	417476	417523	248	7	8	219.1	4.5
200	80	.0200.080.0	417477	417524	316	9	10	219.1	4.5
200	110	.0200.110.0	417478	417525	378	13	15	219.1	4.5
250	48	.0250.048.0	417479	417526	252	10	11	273	5
250	84	.0250.084.0	417480	417527	306	12	14	273	5
250	130	.0250.130.0	417481	417528	484	24	27	273	5

# TYPE ARN 10...

## PN 10

06

Bellows			Nominal movement absorption <sup>1)</sup>		Spring rate		
outside diameter	corrugated length	effective cross-section	angular	lateral	axial	angular	lateral
D <sub>s</sub>	l	A	2c <sub>αN</sub>	2λ <sub>N</sub>	c <sub>0</sub>	c <sub>α</sub>	c <sub>λ</sub>
mm	mm	cm <sup>2</sup>	degree	mm	N/mm	Nm/deg	N/mm
89	54	46	31	5.6	86	1.1	259
90	140	46.6	50	28	112	1.4	51
107	45	68.7	26	3.7	101	1.9	654
107	72	68.7	35	9.4	63	1.2	159
110	165	70.9	51	35	106	2.1	53
121	44	89.1	21	2.8	190	4.7	1670
121	88	89.1	36	11	95	2.4	209
123	168	90.8	48	33	115	2.9	71
149	48	138	22	3.2	159	6.1	1817
149	96	138	36	13	80	3.1	229
152	210	141	48	42	128	5	78
171	56	184	21	3.7	147	7.5	1646
171	98	184	32	11	84	4.3	307
174	208	187	46	38	136	7.1	113
203	60	264	19	3.5	254	19	3564
203	120	264	33	14	127	9.3	445
205	208	267	43	36	133	9.9	157
257	68	436	19	3.8	240	29	4318
257	136	436	31	15	120	15	540
260	198	441	41	31	138	17	297
316	72	670	18	3.9	209	39	5156
316	126	670	27	12	120	22	967
319	304	677	32	45	199	37	278

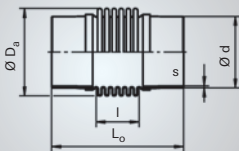
1) Inner sleeve, movement absorption: The inner sleeve is designed for axial movement only.

The movements (axial, angular, lateral) apply to 1000 load changes and are to be regarded as alternativ, i.e. the sum of their proportions in percentages should not exceed 100 %.

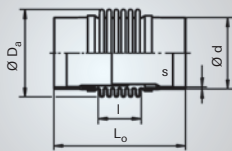


# AXIAL EXPANSION JOINTS WITH WELD ENDS

Type ARN  
without  
inner  
sleeve



Type ARN  
with inner  
sleeve



Nominal diameter	Nominal axial movement absorption <sup>1</sup>	Type ARN 10...	Order No. standard version		Overall length	Weight approx.		Weld end	
			without inner sleeve	with inner sleeve		without inner sleeve	with inner sleeve	outside diameter	wall thickness
DN	2 <sub>N</sub>	-	-	-	L <sub>o</sub>	G	G	d	s
-	mm	-	-	-	mm	kg	kg	-	mm
300	45	.0300.045.0	417482	417529	247	13	15	323.9	5.6
300	90	.0300.090.0	417483	417530	310	16	19	323.9	5.6
300	137	.0300.137.0	417484	417531	514	34	39	323.9	5.6
350	60	.0350.060.0	417486	417532	272	13	15	355.6	8
350	105	.0350.105.0	417487	417533	338	16	20	355.6	8
350	160	.0350.160.0	417488	417534	568	48	55	355.6	8
400	48	.0400.048.0	417489	417535	280	19	22	406.4	8.8
400	120	.0400.120.0	417490	417536	424	32	38	406.4	8.8
400	168	.0400.168.0	417491	417537	548	53	61	406.4	8.8
450	56	.0450.056.0	417492	417538	284	25	29	457	4
450	112	.0450.112.0	417493	417539	384	36	42	457	4
450	168	.0450.168.0	417494	417540	484	46	54	457	4
500	66	.0500.066.0	417495	417541	336	33	38	508	4
500	116	.0500.116.0	417497	417542	417	42	50	508	4
500	192	.0500.192.0	417499	417543	564	71	82	508	4
600	72	.0600.072.0	417500	417544	344	41	46	610	4
600	144	.0600.144.0	417501	417545	460	56	67	610	4
600	216	.0600.216.0	417502	417546	588	89	103	610	4
700	76	.0700.076.0	417503	417547	356	56	63	711	5
700	152	.0700.152.0	417504	417548	484	82	96	711	5
700	209	.0700.209.0	417505	417549	580	102	118	711	5

# TYPE ARN 10...

## PN 10

06

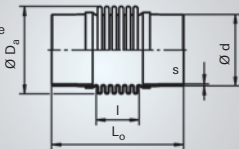
Bellows			Nominal movement absorption <sup>1)</sup>		Spring rate		
outside diameter	corrugated length	effective cross-section	angular	lateral	axial	angular	lateral
D <sub>s</sub>	l	A	2α <sub>N</sub>	2λ <sub>N</sub>	c <sub>0</sub>	c <sub>α</sub>	c <sub>λ</sub>
mm	mm	cm <sup>2</sup>	degree	mm	N/mm	Nm/deg	N/mm
372	63	935	15	2.7	290	75	13045
372	126	935	26	11	145	38	1631
374	330	940	31	44	237	62	391
403	88	1113	17	4.7	250	77	6864
403	154	1113	26	14	143	44	1282
412	384	1140	33	54	267	85	394
464	96	1466	12	3.6	723	294	21961
464	240	1466	26	22	289	118	1405
467	364	1476	32	47	267	109	568
518	100	1844	13	3.9	699	358	24613
518	200	1844	23	15	350	179	3081
518	300	1844	28	35	233	119	912
574	108	2273	14	4.4	620	392	23078
574	189	2273	22	14	354	224	4303
576	336	2282	30	40	279	177	1077
678	116	3222	12	4.3	645	577	29497
678	232	3222	21	17	323	289	3693
680	360	3232	28	40	289	259	1377
785	128	4353	11	4.4	850	1028	43134
785	256	4353	20	17	425	514	5392
785	352	4353	24	33	309	374	2073

1) Inner sleeve, movement absorption: The inner sleeve is designed for axial movement only.

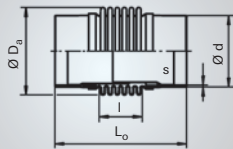
The movements (axial, angular, lateral) apply to 1000 load changes and are to be regarded as alternativ, i.e. the sum of their proportions in percentages should not exceed 100 %.

# AXIAL EXPANSION JOINTS WITH WELD ENDS

Type ARN  
without  
inner sleeve



Type ARN  
with inner  
sleeve



Nominal diameter	Nominal axial movement absorption <sup>1</sup>	Type ARN 16...	Order No. standard version		Overall length	Weight approx.		Weld end	
			without inner sleeve	with inner sleeve		without inner sleeve	with inner sleeve	outside diameter	wall thickness
DN	$2\delta_N$	—	—	—	$L_o$	G	G	d	s
—	mm	—	—	—	mm	kg	kg	—	mm
50	22	.0050.022.0	417550	417585	214	1	1	60.3	2.9
50	42	.0050.042.0	417551	417586	303	2.1	2.4	60.3	2.9
65	28	.0065.028.0	417552	417587	220	1.6	1.8	76.1	2.9
65	48	.0065.048.0	417553	417588	292	2.8	3.2	76.1	2.9
80	23	.0080.023.0	417554	417589	220	2.1	2.4	88.9	3.2
80	50	.0080.050.0	417555	417590	292	3.2	3.6	88.9	3.2
100	31	.0100.031.0	417556	417591	225	2.8	3.2	114.3	3.6
100	58	.0100.058.0	417557	417592	314	5	6	114.3	3.6
125	21	.0125.021.0	417558	417593	218	3	3.4	139.7	4
125	42	.0125.042.0	417559	417594	260	3.7	4.3	139.7	4
125	65	.0125.065.0	417560	417595	336	6	7	139.7	4
150	24	.0150.024.0	417561	417596	221	3.8	4.3	168.3	4
150	48	.0150.048.0	417562	417597	266	4.7	6	168.3	4
150	73	.0150.073.0	417563	417598	336	8	9	168.3	4
200	30	.0200.030.0	417564	417599	234	8	8	219.1	4.5
200	60	.0200.060.0	417565	417600	288	10	11	219.1	4.5
200	97	.0200.097.0	417566	417601	450	19	21	219.1	4.5
250	32	.0250.032.0	417567	417602	256	11	12	273	5
250	64	.0250.064.0	417568	417603	332	14	16	273	5
250	103	.0250.103.0	417569	417604	440	23	26	273	5

# TYPE ARN 16...

## PN 16

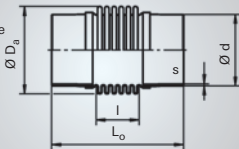
06

Bellows			Nominal movement absorption <sup>1)</sup>		Spring rate		
outside diameter	corrugated length	effective cross-section	angular	lateral	axial	angular	lateral
D <sub>s</sub>	l	A	2c <sub>αN</sub>	2λ <sub>N</sub>	c <sub>0</sub>	c <sub>α</sub>	c <sub>λ</sub>
mm	mm	cm <sup>2</sup>	degree	mm	N/mm	Nm/deg	N/mm
89	54	46	29	5.2	143	1.8	430
91	143	47.2	42	26	149	2	66
108	60	69.4	29	5.9	124	2.4	457
110	132	70.9	40	22	133	2.6	103
122	60	89.9	23	4.3	273	6.8	1302
123	132	90.8	38	20	147	3.7	146
150	65	139	24	5	223	8.6	1400
152	154	141	37	22	174	6.8	198
172	42	185	15	1.9	346	18	6932
172	84	185	27	7.7	173	8.9	867
174	160	187	36	22	177	9.2	248
203	45	264	14	2	339	25	8455
203	90	264	25	7.8	169	12	1054
205	160	267	34	21	173	13	345
260	54	441	14	2.3	508	62	14678
260	108	441	26	9.1	254	31	1835
262	270	445	29	37	271	33	316
318	76	674	12	2.8	634	119	14135
318	152	674	20	11	317	59	1767
320	260	679	27	30	296	56	568

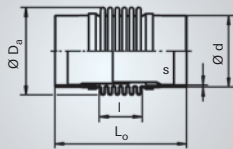
1) Inner sleeve, movement absorption: The inner sleeve is designed for axial movement only. The movements (axial, angular, lateral) apply to 1000 load changes and are to be regarded as alternativ, i.e. the sum of their proportions in percentages should not exceed 100 %.

# AXIAL EXPANSION JOINTS WITH WELD ENDS

Type ARN  
without  
inner sleeve



Type ARN  
with inner  
sleeve



06

Nominal diameter	Nominal axial movement absorption <sup>1</sup>	Type ARN 16...	Order No. standard version		Overall length	Weight approx.		Weld end	
			without inner sleeve	with inner sleeve		without inner sleeve	with inner sleeve	outside diameter	wall thickness
DN	2 $\delta_N$	—	—	—	L <sub>o</sub>	G	G	d	s
—	mm	—	—	—	mm	kg	kg	—	mm
300	40	.0300.040.0	417570	417605	268	16	18	323.9	5.6
300	80	.0300.080.0	417571	417606	352	21	25	323.9	5.6
300	120	.0300.120.0	417572	417607	529	42	48	323.9	5.6
350	40	.0350.040.0	417573	417608	268	18	20	355.6	8
350	90	.0350.090.0	417574	417609	373	25	29	355.6	8
350	130	.0350.130.0	417575	417611	496	43	50	355.6	8
400	48	.0400.048.0	417576	417612	288	26	29	406.4	8.8
400	96	.0400.096.0	417577	417613	392	38	43	406.4	8.8
400	132	.0400.132.0	417578	417614	470	47	54	406.4	8.8
450	52	.0450.052.0	417579	417615	288	29	33	457	5
450	104	.0450.104.0	417580	417616	392	43	50	457	5
450	143	.0450.143.0	417581	417617	470	54	62	457	5
500	48	.0500.048.0	417582	417618	312	34	37	508	5
500	96	.0500.096.0	417583	417619	396	46	53	508	5
500	144	.0500.144.0	417584	417620	480	59	68	508	5

# TYPE ARN 16...

## PN 16

06

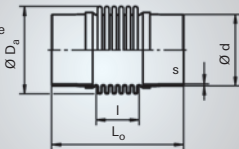
Bellows			Nominal movement absorption <sup>1)</sup>		Spring rate		
outside diameter	corrugated length	effective cross-section	angular	lateral	axial	angular	lateral
D <sub>s</sub>	l	A	2c <sub>αN</sub>	2λ <sub>Nl</sub>	c <sub>0</sub>	c <sub>α</sub>	c <sub>λ</sub>
mm	mm	cm <sup>2</sup>	degree	mm	N/mm	Nm/deg	N/mm
374	84	940	13	3.2	698	182	17764
374	168	940	21	13	349	91	2220
376	345	946	25	40	322	85	489
408	84	1128	12	3	683	214	20856
408	189	1128	20	15	304	95	1834
412	312	1140	26	35	329	104	736
467	104	1476	12	3.8	934	383	24342
467	208	1476	22	15	467	191	3043
467	286	1476	25	29	340	139	1172
520	104	1851	12	3.7	943	485	30826
520	208	1851	21	15	472	243	3857
520	286	1851	24	28	343	176	1483
576	84	2282	9.9	2.5	1117	708	68986
576	168	2282	18	10	558	354	8616
576	252	2282	24	22	372	236	2553

1) Inner sleeve, movement absorption: The inner sleeve is designed for axial movement only.

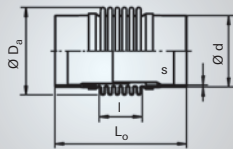
The movements (axial, angular, lateral) apply to 1000 load changes and are to be regarded as alternativ, i.e. the sum of their proportions in percentages should not exceed 100 %.

# AXIAL EXPANSION JOINTS WITH WELD ENDS

Type ARN  
without  
inner sleeve



Type ARN  
with inner  
sleeve



06

Nominal diameter	Nominal axial movement absorption <sup>1</sup>	Type ARN 25...	Order No. standard version		Overall length	Weight approx.		Weld end	
			without inner sleeve	with inner sleeve		without inner sleeve	with inner sleeve	outside diameter	wall thickness
DN	2 $\delta_N$	-	-	-	L <sub>o</sub>	G	G	d	s
-	mm	-	-	-	mm	kg	kg	-	mm
50	17	.0050.017.0	417621	417650	210	1	1	60.3	2.9
50	32	.0050.032.0	417622	417651	270	1.8	2	60.3	2.9
65	21	.0065.021.0	417623	417652	215	1.8	2	76.1	2.9
65	40	.0065.040.0	417624	417653	292	3.2	3.6	76.1	2.9
80	23	.0080.023.0	417625	417654	220	2.3	2.6	88.9	3.2
80	42	.0080.042.0	417626	417655	290	3.6	4	88.9	3.2
100	23	.0100.023.0	417627	417656	212	2.8	3.1	114.3	3.6
100	48	.0100.048.0	417629	417657	286	4.6	5	114.3	3.6
125	26	.0125.026.0	417630	417658	240	3.9	4.4	139.7	4
125	52	.0125.052.0	417631	417659	304	5	6	139.7	4
150	29	.0150.029.0	417632	417660	240	4.9	6	168.3	4
150	58	.0150.058.0	417633	417661	304	7	8	168.3	4
200	26	.0200.026.0	417635	417662	252	9	9	219.1	4.5
200	52	.0200.052.0	417636	417663	324	11	13	219.1	4.5
200	71	.0200.071.0	417637	417664	378	15	17	219.1	4.5
250	24	.0250.024.0	417638	417665	240	12	13	273	5
250	48	.0250.048.0	417639	417666	300	15	17	273	5
250	79	.0250.079.0	417640	417667	380	20	22	273	5
300	27	.0300.027.0	417641	417668	250	15	17	323.9	5.6
300	55	.0300.055.0	417642	417669	316	20	23	323.9	5.6
300	82	.0300.082.0	417643	417670	382	24	29	323.9	5.6

# TYPE ARN 25...

## PN 25

06

Bellows			Nominal movement absorption <sup>1)</sup>		Spring rate		
outside diameter	corrugated length	effective cross-section	angular	lateral	axial	angular	lateral
D <sub>s</sub>	l	A	2α <sub>N</sub>	2λ <sub>N</sub>	c <sub>0</sub>	c <sub>α</sub>	c <sub>λ</sub>
mm	mm	cm <sup>2</sup>	degree	mm	N/mm	Nm/deg	N/mm
90	50	46.6	22	3.6	313	4	1113
91	110	47.2	33	15	194	2.5	144
109	55	70.1	23	4.1	267	5.2	1182
111	132	71.6	33	18	212	4.2	166
123	60	90.8	22	4.2	323	8.1	1555
125	130	92.5	32	17	217	5.6	227
151	52	140	18	3	334	13	3302
152	126	141	30	15	213	8.3	361
174	64	187	18	3.6	442	23	3864
174	128	187	29	14	221	12	483
205	64	267	17	3.4	434	32	5410
205	128	267	27	14	217	16	676
261	72	443	12	2.6	843	104	13759
261	144	443	20	11	422	52	1722
262	198	445	23	20	370	46	802
320	60	679	9	1.6	1281	242	46135
320	120	679	16	6.5	640	121	5762
320	200	679	21	18	384	72	1245
374	66	940	8.7	1.7	1186	310	48892
374	132	940	16	7	593	155	6112
374	198	940	19	16	395	103	1809

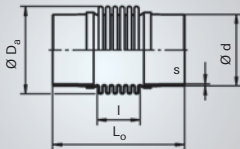
1) Inner sleeve, movement absorption: The inner sleeve is designed for axial movement only.

The movements (axial, angular, lateral) apply to 1000 load changes and are to be regarded as alternativ, i.e. the sum of their proportions in percentages should not exceed 100 %.

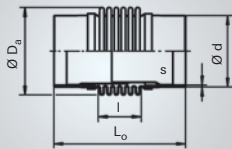


# AXIAL EXPANSION JOINTS WITH WELD ENDS

Type ARN  
without  
inner  
sleeve



Type ARN  
with inner  
sleeve



06

Nominal diameter	Nominal axial movement absorption <sup>1</sup>	Type ARN 25...	Order No. standard version		Overall length	Weight approx.		Weld end	
			without inner sleeve	with inner sleeve		without inner sleeve	with inner sleeve	outside diameter	wall thickness
DN	2 $\delta_N$	–	–	–	L <sub>o</sub>	G	G	d	s
–	mm	–	–	–	mm	kg	kg	–	mm
350	30	.0350.030.0	417644	417671	256	19	21	355.6	8
350	70	.0350.070.0	417645	417672	352	29	33	355.6	8
350	100	.0350.100.0	417646	417673	424	36	41	355.6	8
400	40	.0400.040.0	417647	417674	309	29	32	406.4	8.8
400	80	.0400.080.0	417648	417675	434	45	51	406.4	8.8
400	112	.0400.112.0	417649	417676	562	66	74	406.4	8.8

# TYPE ARN 25...

## PN 25

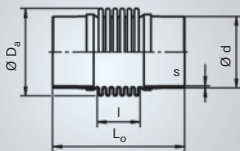
06

Bellows			Nominal movement absorption <sup>1)</sup>		Spring rate		
outside diameter	corrugated length	effective cross-section	angular	lateral	axial	angular	lateral
$D_s$	$l$	$A$	$2c_{\alpha N}$	$2c_{\lambda N}$	$c_0$	$c_{\alpha}$	$c_{\lambda}$
mm	mm	cm <sup>2</sup>	degree	mm	N/mm	Nm/deg	N/mm
412	72	1140	8.8	1.9	1425	451	59854
412	168	1140	18	10	611	193	4714
412	240	1140	21	21	428	136	1618
466	125	1473	10	3.8	1527	625	27484
466	250	1473	17	15	763	312	3433
469	378	1483	19	32	591	243	1171

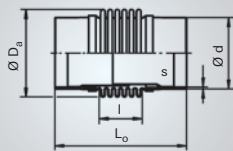
1) Inner sleeve, movement absorption: The inner sleeve is designed for axial movement only. The movements (axial, angular, lateral) apply to 1000 load changes and are to be regarded as alternativ, i.e. the sum of their proportions in percentages should not exceed 100 %.

# AXIAL EXPANSION JOINTS WITH WELD ENDS

Type ARN  
without  
inner  
sleeve



Type ARN  
with inner  
sleeve



Nominal diameter	Nominal axial movement absorption <sup>1</sup>	Type ARN 40...	Order No. standard version		Overall length	Weight approx.		Weld end	
			without inner sleeve	with inner sleeve		without inner sleeve	with inner sleeve	outside diameter	wall thickness
DN	2 <sub>N</sub>	—	—	—	L <sub>o</sub>	G	G	d	s
—	mm	—	—	—	mm	kg	kg	—	mm
50	13	.0050.013.0	417677	417699	204	1	1	60.3	2.9
50	26	.0050.026.0	417678	417700	248	1.6	1.8	60.3	2.9
65	18	.0065.018.0	417679	417701	220	2.2	2.4	76.1	2.9
65	32	.0065.032.0	417680	417702	268	2.9	3.2	76.1	2.9
80	17	.0080.017.0	417681	417703	212	2.4	2.7	88.9	3.2
80	34	.0080.034.0	417682	417704	264	3.2	3.6	88.9	3.2
100	16	.0100.016.0	417683	417705	225	2.7	3.1	114.3	3.6
100	36	.0100.036.0	417684	417706	329	4.7	5	114.3	3.6
125	24	.0125.024.0	417685	417707	272	4.7	5	139.7	4
125	44	.0125.044.0	417687	417708	363	8	9	139.7	4
150	29	.0150.029.0	417688	417709	272	6	7	168.3	4
150	52	.0150.052.0	417689	417710	427	14	15	168.3	4
200	22	.0200.022.0	417690	417711	260	11	11	219.1	4.5
200	44	.0200.044.0	417691	417712	340	15	17	219.1	4.5
200	61	.0200.061.0	417692	417713	400	19	20	219.1	4.5
250	21	.0250.021.0	417693	417714	243	13	14	273	6.3
250	49	.0250.049.0	417694	417715	327	19	21	273	6.3
250	70	.0250.070.0	417695	417717	390	24	27	273	6.3
300	24	.0300.024.0	417696	417718	276	20	22	323.9	7.1
300	54	.0300.054.0	417697	417719	391	30	34	323.9	7.1
300	77	.0300.077.0	417698	417720	534	47	53	323.9	7.1

# TYPE ARN 40...

## PN 40

06

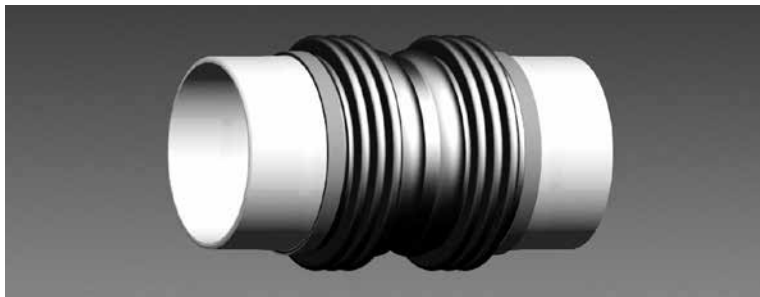
Bellows			Nominal movement absorption <sup>1)</sup>		Spring rate		
outside diameter	corrugated length	effective cross-section	angular	lateral	axial	angular	lateral
D <sub>s</sub>	l	A	2α <sub>N</sub>	2λ <sub>N</sub>	c <sub>0</sub>	c <sub>α</sub>	c <sub>λ</sub>
mm	mm	cm <sup>2</sup>	degree	mm	N/mm	Nm/deg	N/mm
91	44	47.2	17	2.4	484	6.3	2252
91	88	47.2	26	9.7	242	3.2	282
111	60	71.6	19	3.8	467	9.3	1775
111	108	71.6	26	12	259	5.2	304
125	52	92.5	16	2.7	542	14	3540
125	104	92.5	25	11	271	7	442
147	65	136	12	2.6	703	27	4316
147	169	136	18	16	402	15	365
174	96	187	15	5	681	35	2646
175	187	189	21	18	458	24	472
206	96	269	15	5	632	47	3521
208	247	272	20	23	528	40	449
263	80	447	10	2.5	1497	186	19958
263	160	447	17	9.8	748	93	2493
263	220	447	19	19	544	68	959
322	63	683	7.8	1.5	1747	332	57458
322	147	683	16	8.1	749	142	4525
322	210	683	18	17	524	99	1551
376	92	946	7.5	2.1	2339	614	49912
376	207	946	14	11	1039	273	4380
378	350	951	15	26	760	201	1127

1) Inner sleeve, movement absorption: The inner sleeve is designed for axial movement only.

The movements (axial, angular, lateral) apply to 1000 load changes and are to be regarded as alternativ, i.e. the sum of their proportions in percentages should not exceed 100 %.

# UNIVERSAL EXPANSION JOINTS FOR LOW PRESSURE (EXHAUST) WITH WELD ENDS TYPE URN

06



## Type designation

The type designation consists of 2 parts

1. Type series, defined by 3 letters
2. Nominal size, defined by 10 digits

## Example

Type URN: HYDRA universal expansion joint with weld ends

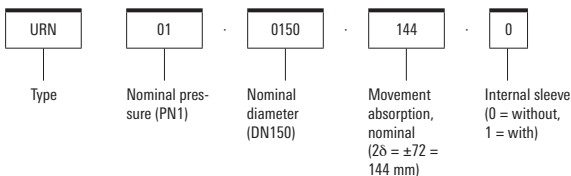
## Standard version/materials

Multi-pley bellow made of 1.4541

Weld end made of P235TR1 (1.0254) or P265GH (1.0425)

Operating temperature: up to 550 °C

## Type designation (example)



## Order text

Please state the following with your order:

For standard versions

- Type designation or order number

With material variation

- Type designation
- Details of materials

The expansion joints for low pressure (exhaust-gas) are designed for unpressurized applications (PS < 0.5 bar gauge pressure).

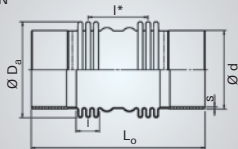
The Pressure Equipment Directive (PED) does not apply to this operating condition.

## Information

Tell us the dimensions that deviate from the standard and we customize the expansion joint to your specification.

# UNIVERSAL EXPANSION JOINTS FOR LOW PRESSURE WITH WELD ENDS

Type URN



06

Nominal diameter	Axial Movement absorption Nominal <sup>1)</sup>	Type URN 01...	Order number standard version	Overall length	Weight approx.	Centre-to-centre distance of bellows	Weld ends	
							outside diameter	wall thickness
DN	2 $\delta_N$	–	–	L <sub>0</sub>	G	I*	d	s
–	mm	–	–	mm	kg	mm	–	mm
50	56	.0050.056.0	425696	480	1.4	257	60.3	2,9
65	83	.0065.083.0	425697	520	2.2	279	76.1	2,9
80	95	.0080.095.0	425698	530	2.6	280	88.9	3,2
100	119	.0100.119.0	425699	550	3.4	291	114.3	3,6
125	144	.0125.144.0	425700	550	4.2	286	139.7	4
150	144	.0150.144.0	423544	563	5	299	168.3	4
200	160	.0200.160.0	423545	572	7	292	219.1	4,5
250	168	.0250.168.0	423546	572	8	293	273	5
300	196	.0300.196.0	423547	562	10	269	323.9	5,6
350	180	.0350.180.0	423548	582	11	302	355.6	8
400	156	.0400.156.0	423549	552	17	266	406.4	8,8
450	140	.0450.140.0	423550	552	18	282	457	4
500	136	.0500.136.0	423551	602	21	310	508	4

# TYPE URN 01... PN 1

06

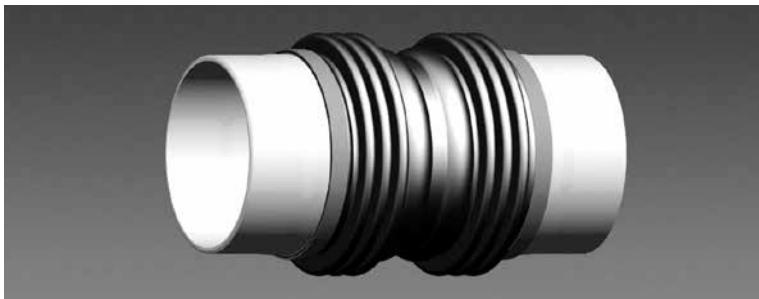
Bellows			Nominal movement absorption <sup>1)</sup>		Spring rate		
outside diameter	corrugated length	effective cross-section	angular	lateral	axial	angular	lateral
D <sub>s</sub>	l	A	2c <sub>αN</sub>	2λ <sub>N</sub>	c <sub>0</sub>	c <sub>α</sub>	c <sub>λ</sub>
mm	mm	cm <sup>2</sup>	degree	mm	N/mm	Nm/deg	N/mm
89	63	46	41	154	37	0.9	1.6
107	81	68.7	49	197	28	1.1	1.5
121	90	89.1	49	196	26	1.3	1.8
148	99	137	49	203	24	1.8	2.4
174	104	187	49	204	18	1.9	2.5
203	104	264	42	181	21	3.1	3.8
255	120	432	37	149	23	5.5	7
312	119	661	31	127	27	9.7	12
365	133	916	31	112	26	13	19
400	120	1104	26	109	27	17	20
458	126	1445	20	71	88	71	106
513	110	1825	16	62	97	98	135
569	92	2252	14	62	107	134	155

1) Inner sleeve, movement absorption: The inner sleeve is designed for axial movement only. The movements (axial, angular, lateral) apply to 1000 load changes and are to be regarded as alternativ, i.e. the sum of their proportions in percentages should not exceed 100 %.



# UNIVERSAL EXPANSION JOINTS WITH WELD ENDS TYPE URN

06



## Type designation

The type designation consists of 2 parts

1. Type series, defined by 3 letters
2. Nominal size, defined by 10 digits

## Example

Type URN: HYDRA Universal-expansion joint with weld ends

## Standard version/materials:

Multi-ply bellow made of 1.4541

Weld ends up to DN 300: P235GH (1.0345)

Weld ends from DN 350: P265GH (1.0425)

Operating temperature: up to 400 °C

## Type designation (example)

URN

Type

06

Nominal pressure (PN6)

0150

Nominal diameter (DN150)

096

Movement absorption, nominal ( $2\delta = \pm 48 = 96$  mm)

0

Internal sleeve (0 = without, 1 = with)

## Order text according to guideline 2014/68/EU "Pressure Equipment Directive"

Please state the following with your order:

For standard versions

- Type designation or order number

With material variation

- Type designation
- Details of the materials

According to the Pressure Equipment Directive, the following information is required for testing and documentation:

06

Type of pressure equipment according to Art. 1 & 2:

- Vessel - volume V [l] \_\_\_\_\_
- Piping - nominal diameter DN \_\_\_\_\_

Medium property according to Art. 13:

- Group 1 – dangerous
- Group 2 – all other fluids

State of medium

- Gaseous or liquid if PD > 0.5 bar
- Liquid if PD ≤ 0.5 bar

Design data:

- Max. allowable pressure [bar] \_\_\_\_\_
- Max./min. allowable temperature [°C] \_\_\_\_\_
- Test pressure PT [bar] \_\_\_\_\_

Optional:

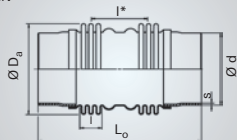
- Category \_\_\_\_\_

### Note

Tell us the dimensions that deviate from the standard and we customize the expansion joint to your specification.

# UNIVERSAL EXPANSION JOINTS WITH WELD ENDS

Type URN



06

Nominal diameter	Nominal axial movement absorption <sup>1)</sup>	Type URN 06...	Order No. standard version	Overall length	Weight approx.	Centre-to-centre distance of bellows	Weld ends	
							outside diameter	wall thickness
DN	$2\delta_n$	—	—	$L_o$	G	$I^*$	d	s
—	mm	—	—	mm	kg	mm	—	mm
50	44	.0050.044.0	425701	430	1.6	216	60.3	3
65	55	.0065.055.0	425702	430	2.3	210	76.1	2,9
80	61	.0080.061.0	425703	450	2.7	224	88.9	3,2
100	73	.0100.073.0	425704	470	4.7	232	114.3	3,6
125	84	.0125.084.0	425705	500	6	240	139.7	4
150	96	.0150.096.0	423552	517	8	251	168.3	4
200	100	.0200.100.0	423553	558	12	293	219.1	4,5
250	120	.0250.120.0	423554	484	15	214	273	5
300	100	.0300.100.0	423555	509	17	230	323.9	5,6
350	110	.0350.110.0	423557	515	16	231	355.6	8
400	130	.0400.130.0	423558	521	23	227	406.4	8,8
450	140	.0450.140.0	423559	541	26	242	457	4
500	132	.0500.132.0	423560	594	37	266	508	4

# TYPE URN 06...

## PN 6

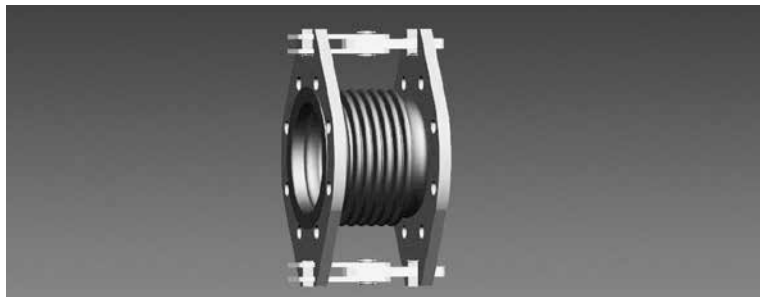
06

Bellows			Nominal movement absorption <sup>1)</sup>		Spring rate		
outside diameter	corrugated length	effective cross-section	angular	lateral	axial	angular	lateral
D <sub>s</sub>	l	A	2c <sub>αN</sub>	2λ <sub>Nl</sub>	c <sub>0</sub>	c <sub>α</sub>	c <sub>λ</sub>
mm	mm	cm <sup>2</sup>	degree	mm	N/mm	Nm/deg	N/mm
89	54	46	31	102	72	1.8	4.4
108	60	69.4	31	99	62	2.4	6
121	66	89.1	30	102	63	3.1	7
150	78	139	29	99	93	7.2	15
172	84	185	29	101	87	8.9	17
203	90	264	27	101	85	12	22
257	85	436	23	99	96	23	30
316	90	670	22	66	84	31	73
371	95	932	16	50	111	57	118
405	100	1119	15	50	109	68	137
461	110	1456	16	50	144	116	239
514	115	1828	16	51	146	148	269
572	100	2265	14	50	206	259	400

1) Inner sleeve, movement absorption: The inner sleeve is designed for axial movement only. The movements (axial, angular, lateral) apply to 1000 load changes and are to be regarded as alternativ, i.e. the sum of their proportions in percentages should not exceed 100 %.

# ANGULAR EXPANSION JOINTS WITH LOOSE FLANGES TYPE WBN, WBK

06



## Type designation

The type designation consists of 2 parts

1. Type series, defined by 3 letters
2. Nominal size, defined by 10 digits

## Example

Type WBN:

HYDRA single hinge angular expansion joint with loose flanges

Type WBK:

HYDRA gimbal hinge angular expansion joint with loose flanges

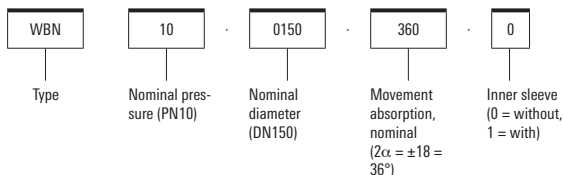
## Standard version/materials:

Multi-ply bellows made of 1.4541

Flange made of P265GH (1.0425)

Operating temperature: up to 400 °C

## Type designation (example)



## Order text according to guideline 2014/68/EU "Pressure Equipment Directive"

Please state the following with your order:

For standard versions

- Type designation or order number

With material variation

- Type designation
- Details of the materials

According to the Pressure Equipment Directive, the following information is required for testing and documentation:

06

Type of pressure equipment according to Art. 1 & 2:

- Vessel - volume V [l] \_\_\_\_\_
- Piping - nominal diameter DN \_\_\_\_\_

Medium property according to Art. 13:

- Group 1 – dangerous
- Group 2 – all other fluids

State of medium

- Gaseous or liquid if PD > 0.5 bar
- Liquid if PD ≤ 0.5 bar

Design data:

- Max. allowable pressure [bar] \_\_\_\_\_
- Max./min. allowable temperature [°C] \_\_\_\_\_
- Test pressure PT [bar] \_\_\_\_\_

Optional:

- Category \_\_\_\_\_

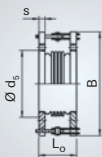
### Note

Tell us the dimensions that deviate from the standard and we customize the expansion joint to your specification.

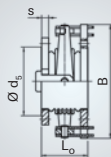
On request, flanges can also be supplied with other hole patterns / flange sheet thicknesses. In this case, the specified overall length L0 may change.

# ANGULAR EXPANSION JOINTS WITH LOOSE FLANGES

Type WBN



Type WBK



06

Nominal diameter	Nominal angular movement absorption	Type WBN 06... WBK 06...	Order No. standard version		WBN		WBK	
			WBN	WBK	overall length	weight approx.	overall length	weight approx.
DN	$2\alpha_n$	–	–	–	$L_o$	G	$L_o$	G
–	degree	–	–	–	mm	kg	mm	kg
50	33.0	.0050.330.0	441221	441136	121	7	121	11
50	41.0	.0050.410.0	441222	441137	141	7	141	11
65	27.0	.0065.270.0	441223	441138	111	9	111	13
65	39.0	.0065.390.0	441224	441139	141	9	141	13
80	27.0	.0080.270.0	441225	441140	121	11	121	16
80	38.0	.0080.380.0	441226	441141	151	12	151	17
100	27.0	.0100.270.0	441227	441142	131	12	131	17
100	38.0	.0100.380.0	441228	441143	161	12	161	18
125	30.0	.0125.300.0	441229	441144	151	15	151	21
125	39.0	.0125.390.0	441230	441145	181	16	181	22
150	23.0	.0150.230.0	441231	441146	162	16	162	23
150	36.0	.0150.360.0	441232	441147	212	18	212	24
200	23.0	.0200.230.0	441233	441148	172	22	172	33
200	34.0	.0200.340.0	441234	441149	233	25	233	35
250	18.0	.0250.180.0	441235	441150	183	29	183	40
250	32.0	.0250.320.0	441236	441151	253	31	253	43
300	19.0	.0300.190.0	441237	-	183	38	-	-
300	34.0	.0300.340.0	441238	441153	263	41	263	59

# SINGLE HINGE VERSION TYPE WBN 06 ... GIMBAL HINGE VERSION TYPE WBK 06 ...

## PN 6

06

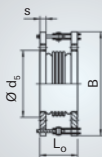
Max. width approx.	Flange <sup>2)</sup>			Spring rate		
	drilling DIN 1092	rim diameter	thickness			
<b>B</b>	<b>PN</b>	<b>d<sub>s</sub></b>	<b>s</b>	<b>c<sub>r</sub></b>	<b>c<sub>α</sub></b>	<b>c<sub>p</sub></b>
mm	-	mm	mm	Nm/bar	Nm/deg	Nm/deg bar
250	6	90	16	0.5	1.1	0.1
250	6	90	16	0.5	0.8	0.1
285	6	107	16	0.7	1.9	0.1
285	6	107	16	0.7	1.2	0.1
310	6	122	18	0.9	2.3	0.1
310	6	122	18	0.9	1.5	0.2
325	6	147	18	1.4	3.3	0.2
325	6	147	18	1.4	2.1	0.4
355	6	178	20	1.9	3	0.4
355	6	178	20	1.9	2.1	0.5
370	6	202	20	2.6	8.5	0.5
370	6	202	20	2.6	4.7	1.0
425	6	258	22	4	13	1.0
425	6	258	22	4	15	1.7
485	6	312	24	7	39	1.4
485	6	312	24	7	20	2.8
565	6	365	24	9	47	2.2
565	6	365	24	9	24	4.3

2) Available with other hole patterns / thicknesses on request. The overall length L0 may change then.

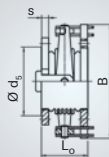


# ANGULAR EXPANSION JOINTS WITH LOOSE FLANGES

Type WBN



Type WBK



Nominal diameter	Nominal angular movement absorption	Type WBN 06... WBK 06...	Order No. standard version		WBN		WBK	
			WBN	WBK	overall length	weight approx.	overall length	weight approx.
DN	$2\alpha_N$	–	–	–	$L_o$	G	$L_o$	G
–	degree	–	–	–	mm	kg	mm	kg
350	18.0	.0350.180.0	441239	-	193	61	-	-
350	34.0	.0350.340.0	441240	441155	314	69	314	101
400	13.0	.0400.130.0	441241	-	213	68	-	-
400	27.0	.0400.270.0	441242	441157	343	77	343	116
450	13.0	.0450.130.0	441243	-	213	76	-	-
450	24.0	.0450.240.0	441244	441158	333	85	333	134
500	14.0	.0500.140.0	441245	-	224	86	-	-
500	26.0	.0500.260.0	441246	441159	354	99	354	159
600	13.0	.0600.130.0	441247	-	254	155	-	-
600	25.0	.0600.250.0	441248	441160	394	175	394	290
700	14.0	.0700.140.0	441249	-	284	176	-	-
700	25.0	.0700.250.0	441250	441161	446	220	446	383
800	11.0	.0800.110.0	441251	-	296	242	-	-
800	23.0	.0800.230.0	441252	441162	496	286	496	501

# SINGLE HINGE VERSION TYPE WBN 06 ... GIMBAL HINGE VERSION TYPE WBK 06 ...

## PN 6

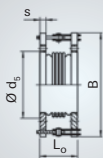
06

Max. width approx.	Flange <sup>2)</sup>			Spring rate		
	drilling DIN 1092	rim diameter	thickness			
<b>B</b>	<b>PN</b>	<b>d<sub>5</sub></b>	<b>s</b>	<b>c<sub>r</sub></b>	<b>c<sub>s</sub></b>	<b>c<sub>p</sub></b>
mm	-	mm	mm	Nm/bar	Nm/deg	Nm/deg bar
650	6	410	26	20	65	2.7
650	6	410	26	20	35	6.4
680	6	465	28	26	146	3.7
680	6	465	28	26	58	9.3
740	6	520	28	33	186	4.9
740	6	520	28	33	83	11.0
800	6	570	28	41	260	6.6
800	6	570	28	41	116	15.0
950	6	670	37	77	370	10.0
950	6	670	37	77	164	24.0
1060	6	775	37	104	422	18.0
1060	6	775	37	104	308	38.0
1180	6	880	43	135	1002	22.0
1180	6	880	43	135	401	54.0

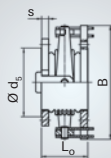
2) Available with other hole patterns / thicknesses on request. The overall length L0 may change then.

# ANGULAR EXPANSION JOINTS WITH LOOSE FLANGES

Type WBN



Type WBK



06

Nominal diameter	Nominal angular movement absorption	Type WBN 10... WBK 10...	Order No. standard version		WBN		WBK	
			WBN	WBK	overall length	weight approx.	overall length	weight approx.
DN	$2\alpha_n$	—	—	—	$L_o$	G	$L_o$	G
—	degree	—	—	—	mm	kg	mm	kg
50	31.0	.0050.310.0	441253	441163	131	10	131	14
50	37.0	.0050.370.0	441254	441164	151	10	151	14
65	26.0	.0065.260.0	441255	441165	121	11	121	16
65	37.0	.0065.370.0	441256	441166	162	12	162	16
80	25.0	.0080.250.0	441257	441167	132	12	132	18
80	36.0	.0080.360.0	441258	441168	162	13	162	18
100	26.0	.0100.260.0	441259	441169	142	15	142	21
100	36.0	.0100.360.0	441260	441170	182	16	182	22
125	25.0	.0125.250.0	441261	441171	162	18	162	23
125	34.0	.0125.340.0	441262	441172	202	19	202	25
150	23.0	.0150.230.0	441263	441173	173	23	173	32
150	36.0	.0150.360.0	441264	441174	233	24	233	34
200	22.0	.0200.220.0	441265	441175	183	29	183	40
200	32.0	.0200.320.0	441266	441176	234	31	234	42
250	18.0	.0250.180.0	441267	441177	183	46	183	70
250	30.0	.0250.300.0	441268	441178	264	51	264	75
300	23.0	.0300.230.0	441269	-	224	57	-	-
300	29.0	.0300.290.0	441270	441180	264	60	264	91

# SINGLE HINGE VERSION TYPE WBN 10 ... GIMBAL HINGE VERSION TYPE WBK 10 ...

## PN 10

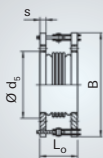
06

Max. width approx.	Flange <sup>2)</sup>			Spring rate		
	drilling DIN 1092	rim diameter	thickness			
<b>B</b>	<b>PN</b>	<b>d<sub>s</sub></b>	<b>s</b>	<b>c<sub>r</sub></b>	<b>c<sub>s</sub></b>	<b>c<sub>p</sub></b>
mm	-	mm	mm	Nm/bar	Nm/deg	Nm/deg bar
275	16	92	19	0.5	1.1	0.1
275	16	92	19	0.5	0.8	0.1
295	16	107	20	0.7	1.9	0.1
295	16	107	20	0.7	1.8	0.2
310	16	122	20	0.9	3.8	0.1
310	16	122	20	0.9	2.4	0.2
335	16	147	22	1.4	4.9	0.2
335	16	147	22	1.4	3.1	0.4
355	16	178	22	1.8	6	0.4
355	16	178	22	1.8	3.8	0.6
385	16	208	24	2.6	15	0.6
385	16	208	24	2.6	8.4	1.0
450	10	258	24	4	23	1.1
450	10	258	24	4	17	1.7
540	10	320	26	12	39	1.4
540	10	320	26	12	22	3.0
600	10	370	28	17	45	2.9
600	10	370	28	17	32	4.0

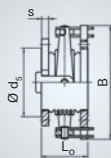
2) Available with other hole patterns / thicknesses on request. The overall length L0 may change then.

# ANGULAR EXPANSION JOINTS WITH LOOSE FLANGES

Type WBN



Type WBK



Nominal diameter	Nominal angular movement absorption	Type WBN 10... WBK 10...	Order No. standard version		WBN		WBK	
			WBN	WBK	overall length	weight approx.	overall length	weight approx.
DN	$2\alpha_N$	–	–	–	$L_o$	G	$L_o$	G
–	degree	–	–	–	mm	kg	mm	kg
350	17.0	.0350.170.0	441271	-	204	68	-	-
350	26.0	.0350.260.0	441272	441181	274	73	274	113
400	12.0	.0400.120.0	441273	-	226	92	-	-
400	26.0	.0400.260.0	441274	441182	376	108	376	162
450	13.0	.0450.130.0	441275	-	246	115	-	-
450	25.0	.0450.250.0	441276	441183	366	131	366	204
500	14.0	.0500.140.0	441277	-	256	153	-	-
500	25.0	.0500.250.0	441278	441184	386	174	386	274
600	12.0	.0600.120.0	441279	-	276	193	-	-
600	23.0	.0600.230.0	441280	441185	416	219	416	378

# SINGLE HINGE VERSION TYPE WBN 10 ... GIMBAL HINGE VERSION TYPE WBK 10 ...

## PN 10

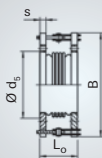
06

Max. width approx.	Flange <sup>2)</sup>			Spring rate		
	drilling DIN 1092	rim diameter	thickness			
<b>B</b>	<b>PN</b>	<b>d<sub>s</sub></b>	<b>s</b>	<b>c<sub>r</sub></b>	<b>c<sub>s</sub></b>	<b>c<sub>p</sub></b>
mm	-	mm	mm	Nm/bar	Nm/deg	Nm/deg bar
660	10	410	28	20	78	2.8
660	10	410	28	20	45	5.0
710	10	465	32	26	297	4.1
710	10	465	32	26	119	10.0
810	10	520	37	33	362	5.4
810	10	520	37	33	161	12.0
860	10	570	37	55	395	7.1
860	10	570	37	55	176	16.0
980	10	670	43	77	581	11.0
980	10	670	43	77	259	24.0

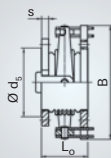
2) Available with other hole patterns / thicknesses on request. The overall length L0 may change then.

# ANGULAR EXPANSION JOINTS WITH LOOSE FLANGES

Type WBN



Type WBK



06

Nominal diameter	Nominal angular movement absorption	Type WBN 16... WBK 16...	Order No. standard version		WBN		WBK	
			WBN	WBK	overall length	weight approx.	overall length	weight approx.
DN	2 $\alpha_N$	–	–	–	L <sub>o</sub>	G	L <sub>o</sub>	G
–	degree	–	–	–	mm	kg	mm	kg
50	25.0	.0050.250.0	441281	441186	122	10	122	15
50	34.0	.0050.340.0	441282	441187	152	10	152	15
65	25.0	.0065.250.0	441283	441188	132	11	132	16
65	34.0	.0065.340.0	441284	441189	163	12	163	17
80	23.0	.0080.230.0	441285	441190	143	13	143	18
80	32.0	.0080.320.0	441286	441191	173	14	173	19
100	24.0	.0100.240.0	441287	441192	153	16	153	23
100	33.0	.0100.330.0	441288	441193	183	17	183	24
125	24.0	.0125.240.0	441289	441194	163	19	163	27
125	33.0	.0125.330.0	441290	441195	214	20	214	29
150	22.0	.0150.220.0	441291	441196	173	23	173	33
150	31.0	.0150.310.0	441292	441197	224	25	224	34
200	22.0	.0200.220.0	441293	441198	195	43	195	64
200	31.0	.0200.310.0	441294	441199	245	46	245	67
250	14.0	.0250.140.0	441295	441200	214	53	214	82
250	23.0	.0250.230.0	441296	441201	285	60	285	89
300	15.0	.0300.150.0	441297	-	235	76	-	-
300	22.0	.0300.220.0	441298	441202	325	83	325	123
350	12.0	.0350.120.0	441299	-	215	98	-	-
350	19.0	.0350.190.0	441300	441203	305	106	305	161

# SINGLE HINGE VERSION TYPE WBN 16 ... GIMBAL HINGE VERSION TYPE 16 ...

## PN 16

06

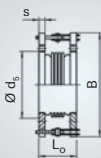
Max. width approx.	Flange <sup>2)</sup>			Spring rate		
	drilling DIN 1092	rim diameter	thickness	$c_r$	$c_c$	$c_p$
<b>B</b>	<b>PN</b>	<b>d<sub>s</sub></b>	<b>s</b>	<b>c<sub>r</sub></b>	<b>c<sub>c</sub></b>	<b>c<sub>p</sub></b>
mm	-	mm	mm	Nm/bar	Nm/deg	Nm/deg bar
275	16	92	19	0.5	2.2	0.1
275	16	92	19	0.5	1.4	0.1
295	16	107	20	0.7	2.9	0.1
295	16	107	20	0.7	3.3	0.2
310	16	122	20	0.9	6.9	0.2
310	16	122	20	0.9	4.3	0.3
335	16	147	22	1.4	8.8	0.3
335	16	147	22	1.4	5.5	0.4
365	16	178	22	1.9	11	0.4
365	16	178	22	1.9	8.1	0.7
395	16	208	24	2.6	15	0.6
395	16	208	24	2.7	11	1.0
500	16	258	26	8	38	1.2
500	16	258	26	8	24	1.8
540	16	320	29	12	96	1.9
540	16	320	29	12	67	3.4
600	16	375	37	17	147	2.9
600	16	375	37	17	82	5.2
720	16	410	37	20	216	2.8
720	16	410	37	20	108	5.5

2) Available with other hole patterns / thicknesses on request. The overall length L0 may change then.

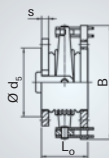


# ANGULAR EXPANSION JOINTS WITH LOOSE FLANGES

Type WBN



Type WBK



Nominal diameter	Nominal angular movement absorption	Type WBN 25... WBK 25...	Order No. standard version		WBN		WBK	
			WBN	WBK	overall length	weight approx.	overall length	weight approx.
DN	$2\alpha_n$	—	—	—	$L_o$	G	$L_o$	G
—	degree	—	—	—	mm	kg	mm	kg
50	22.0	.0050.220.0	441301	441204	133	11	133	15
50	30.0	.0050.300.0	441302	441205	163	11	163	16
65	23.0	.0065.230.0	441303	441206	143	13	143	18
65	30.0	.0065.300.0	441304	441207	173	14	173	19
80	22.0	.0080.220.0	441305	441208	144	15	144	22
80	28.0	.0080.280.0	441306	441209	174	16	174	23
100	22.0	.0100.220.0	441307	441210	154	20	154	28
100	27.0	.0100.270.0	441308	441211	184	21	184	29
125	22.0	.0125.220.0	441309	441212	185	26	185	35
125	29.0	.0125.290.0	441310	441213	235	27	235	36
150	20.0	.0150.200.0	441311	441214	185	43	185	61
150	27.0	.0150.270.0	441312	441215	235	45	235	63
200	14.0	.0200.140.0	441313	441216	205	52	205	78
200	22.0	.0200.220.0	441314	441217	276	59	276	84
250	14.0	.0250.140.0	441315	-	236	73	-	-
250	20.0	.0250.200.0	441316	441218	296	78	296	118
300	14.0	.0300.140.0	441317	-	256	121	-	-
300	19.0	.0300.190.0	441318	441219	346	131	346	204
350	11.0	.0350.110.0	441319	-	258	163	-	-
350	18.0	.0350.180.0	441320	441220	328	174	328	266

# SINGLE HINGE VERSION TYPE WBN 25 ... GIMBAL HINGE VERSION TYPE WBK 25 ...

## PN 25

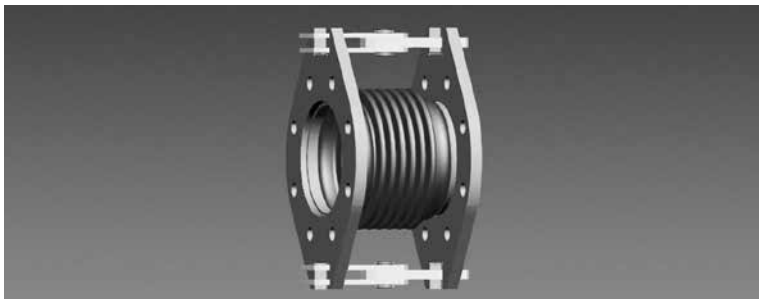
06

Max. width approx.	Flange <sup>2)</sup>			Spring rate		
	drilling DIN 1092	rim diameter	thickness	$c_r$	$c_c$	$c_p$
<b>B</b>	<b>PN</b>	<b>d<sub>s</sub></b>	<b>s</b>	<b>c<sub>r</sub></b>	<b>c<sub>c</sub></b>	<b>c<sub>p</sub></b>
mm	-	mm	mm	Nm/bar	Nm/deg	Nm/deg bar
275	40	92	20	0.5	4.2	0.1
275	40	92	20	0.5	2.6	0.1
295	40	107	22	0.7	5.3	0.1
295	40	107	22	0.7	3.3	0.2
310	40	122	24	0.9	8.3	0.2
310	40	122	24	0.9	5.9	0.2
340	40	147	24	1.4	11	0.3
340	40	147	24	1.4	7.5	0.4
365	40	178	26	1.9	19	0.4
365	40	178	26	1.9	12	0.7
460	40	208	28	4.8	26	0.6
460	40	208	28	4.8	16	1.0
500	25	258	32	8	84	1.2
500	25	258	32	8	57	2.1
570	25	320	37	12	147	2.0
570	25	320	37	12	92	3.2
670	25	375	43	23	188	3.0
670	25	375	43	23	104	5.4
750	25	410	47	27	343	3.2
750	25	410	47	27	196	5.6

2) Available with other hole patterns / thicknesses on request. The overall length L0 may change then.

# ANGULAR EXPANSION JOINTS WITH PLAIN FIXED FLANGES TYPE WFN, WFK

06



## Type designation

The type designation consists of 2 parts

1. Type series, defined by 3 letters
2. Nominal size, defined by 10 digits

## Example

Type WFN:

HYDRA single hinge angular expansion joint with plain fixed flanges

Type WFK:

HYDRA gimbal hinge angular expansion joint with plain fixed flanges

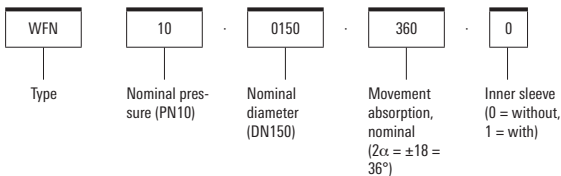
## Standard version/materials:

Multi-ply bellows made of 1.4541

Flange made of P265GH (1.0425)

Operating temperature: up to 400 °C

## Type designation (example)



## Order text according to guideline 2014/68/EU "Pressure Equipment Directive"

Please state the following with your order:

For standard versions

- Type designation or order number

With material variation

- Type designation
- Details of the materials

According to the Pressure Equipment Directive, the following information is required for testing and documentation:

06

Type of pressure equipment according to Art. 1 & 2:

- Vessel - volume V [l] \_\_\_\_\_
- Piping - nominal diameter DN \_\_\_\_\_

Medium property according to Art. 13:

- Group 1 – dangerous
- Group 2 – all other fluids

State of medium

- Gaseous or liquid if PD > 0.5 bar
- Liquid if PD ≤ 0.5 bar

Design data:

- Max. allowable pressure [bar] \_\_\_\_\_
- Max./min. allowable temperature [°C] \_\_\_\_\_
- Test pressure PT [bar] \_\_\_\_\_

Optional:

- Category \_\_\_\_\_

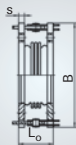
### Note

Tell us the dimensions that deviate from the standard and we customize the expansion joint to your specification.

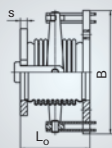
On request, flanges can also be supplied with other hole patterns / flange sheet thicknesses. In this case, the specified overall length L0 may change.

# ANGULAR EXPANSION JOINTS WITH PLAIN FIXED FLANGES

Type WFN



Type WFK



06

Nominal diameter	Nominal angular movement absorption	Type WFN 06... WFK 06...	Order No. standard version		WFN		WFK	
			WFN	WFK	overall length	weight approx.	overall length	weight approx.
DN	$2\alpha_N$	–	–	–	$L_0$	G	$L_0$	G
–	degree	–	–	–	mm	kg	mm	kg
50	33.0	.0050.330.0	442098	441321	140	7	140	11
50	41.0	.0050.410.0	442099	441322	160	7	160	11
65	27.0	.0065.270.0	442100	441323	130	8	130	13
65	39.0	.0065.390.0	442101	441324	160	9	160	13
80	27.0	.0080.270.0	442102	441325	140	11	140	16
80	38.0	.0080.380.0	442103	441326	170	12	170	17
100	27.0	.0100.270.0	442104	441327	140	12	140	17
100	38.0	.0100.380.0	442105	441328	170	13	170	18
125	30.0	.0125.300.0	442106	441329	160	15	160	21
125	39.0	.0125.390.0	442107	441330	190	16	190	22
150	23.0	.0150.230.0	442108	441331	170	17	170	23
150	36.0	.0150.360.0	442109	441332	220	17	220	24
200	23.0	.0200.230.0	442110	441333	180	22	180	32
200	34.0	.0200.340.0	442111	441334	240	24	240	35
250	18.0	.0250.180.0	442112	441335	180	28	180	40
250	32.0	.0250.320.0	442113	441336	260	31	260	42
300	19.0	.0300.190.0	442114	-	190	37	-	-
300	34.0	.0300.340.0	442115	441338	270	41	270	59

# SINGLE HINGE VERSION TYPE WFN 06 ... GIMBAL HINGE VERSION TYPE WFK 06 ...

## PN 6

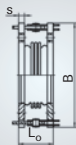
06

Max. width approx.	Flange <sup>2)</sup>		Spring rate		
	drilling DIN 1092	thickness	$c_r$	$c_{\alpha}$	$c_{\beta}$
B	PN	s	$c_r$	$c_{\alpha}$	$c_{\beta}$
mm	-	mm	Nm/bar	Nm/deg	Nm/deg bar
250	6	16	0.5	1.1	0.10
250	6	16	0.5	0.8	0.1
285	6	16	0.7	1.9	0.1
285	6	16	0.7	1.2	0.1
310	6	18	0.9	2.3	0.1
310	6	18	0.9	1.4	0.2
325	6	18	1.4	3.3	0.2
325	6	18	1.4	2.1	0.4
355	6	20	1.9	3	0.4
355	6	20	1.9	2.1	0.5
370	6	20	2.6	8.5	0.5
370	6	20	2.6	4.7	1.0
425	6	22	4	13	1.0
425	6	22	4	15	1.7
485	6	24	7	39	1.4
485	6	24	7	20	2.8
565	6	24	9	47	2.2
565	6	24	9	24	4.3

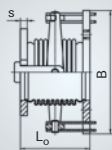
2) Available with other hole patterns / thicknesses on request. The overall length L0 may change then.

# ANGULAR EXPANSION JOINTS WITH PLAIN FIXED FLANGES

Type WFN



Type WFK



06

Nominal diameter	Nominal angular movement absorption	Type WFN 06... WFK 06...	Order No. standard version		WFN		WFK	
			WFN	WFK	overall length	weight approx.	overall length	weight approx.
DN	$2\alpha_N$	–	–	–	$L_0$	G	$L_0$	G
–	degree	–	–	–	mm	kg	mm	kg
350	18.0	.0350.180.0	442116	-	200	60	-	-
350	34.0	.0350.340.0	442117	441340	310	68	310	100
400	13.0	.0400.130.0	442118	-	210	66	-	-
400	27.0	.0400.270.0	442119	441342	340	76	340	115
450	13.0	.0450.130.0	442120	-	210	74	-	-
450	24.0	.0450.240.0	442121	441343	330	83	330	133
500	14.0	.0500.140.0	442122	-	220	84	-	-
500	26.0	.0500.260.0	442123	441344	350	97	350	157
600	13.0	.0600.130.0	442124	-	250	152	-	-
600	25.0	.0600.250.0	442125	441345	390	172	390	287
700	14.0	.0700.140.0	442126	-	280	173	-	-
700	25.0	.0700.250.0	442127	441346	440	214	440	378
800	11.0	.0800.110.0	442128	-	290	235	-	-
800	23.0	.0800.230.0	442129	441347	490	279	490	494

# SINGLE HINGE VERSION TYPE WFN 06 ... GIMBAL HINGE VERSION TYPE WFK 06 ...

## PN 6

06

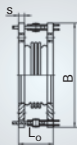
Max. width approx.	Flange <sup>2)</sup>		Spring rate		
	drilling DIN 1092	thickness	$c_r$	$c_{\alpha}$	$c_p$
B	PN	s	$c_r$	$c_{\alpha}$	$c_p$
mm	-	mm	Nm/bar	Nm/deg	Nm/deg bar
650	6	26	20	65	2.7
650	6	26	20	34	6.4
680	6	28	26	145	3.7
680	6	28	26	58	9.3
740	6	28	33	185	4.9
740	6	28	33	82	11.0
800	6	28	41	259	6.6
800	6	28	41	115	15.0
950	6	37	77	368	10.0
950	6	37	77	164	24.0
1060	6	37	104	420	18.0
1060	6	37	104	305	38.0
1180	6	43	135	998	22.0
1180	6	43	135	400	54.0

2) Available with other hole patterns / thicknesses on request. The overall length L0 may change then.

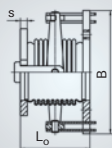


# ANGULAR EXPANSION JOINTS WITH PLAIN FIXED FLANGES

Type WFN



Type WFK



06

Nominal diameter	Nominal angular movement absorption	Type WFN 10... WFK 10...	Order No. standard version		WFN		WFK	
			WFN	WFK	overall length	weight approx.	overall length	weight approx.
DN	$2\alpha_N$	—	—	—	$L_0$	G	$L_0$	G
—	degree	—	—	—	mm	kg	mm	kg
50	31.0	.0050.310.0	442130	441348	140	10	140	14
50	37.0	.0050.370.0	442131	441349	160	10	160	14
65	26.0	.0065.260.0	442132	441350	130	11	130	16
65	37.0	.0065.370.0	442133	441351	170	12	170	17
80	25.0	.0080.250.0	442134	441352	140	12	140	17
80	36.0	.0080.360.0	442135	441353	180	13	180	18
100	26.0	.0100.260.0	442136	441354	150	15	150	20
100	36.0	.0100.360.0	442137	441355	190	16	190	22
125	25.0	.0125.250.0	442138	441356	170	18	170	24
125	34.0	.0125.340.0	442139	441357	210	18	210	24
150	23.0	.0150.230.0	442140	441358	180	23	180	32
150	36.0	.0150.360.0	442141	441359	240	24	240	33
200	22.0	.0200.220.0	442142	441360	190	28	190	39
200	32.0	.0200.320.0	442143	441361	240	31	240	41
250	18.0	.0250.180.0	442144	441362	190	46	190	69
250	30.0	.0250.300.0	442145	441363	270	51	270	75
300	23.0	.0300.230.0	442146	-	220	56	-	-
300	29.0	.0300.290.0	442147	441365	260	59	260	90

# SINGLE HINGE VERSION TYPE WFN 10 ... GIMBAL HINGE VERSION TYPE WFK 10 ...

## PN 10

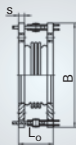
06

Max. width approx.	Flange <sup>2)</sup>		Spring rate		
	drilling DIN 1092	thickness	$c_r$	$c_{\alpha}$	$c_{\beta}$
B	PN	s	$c_r$	$c_{\alpha}$	$c_{\beta}$
mm	–	mm	Nm/bar	Nm/deg	Nm/deg bar
275	16	19	0.5	1.1	0.07
275	16	19	0.5	0.8	0.1
295	16	20	0.7	1.9	0.1
295	16	20	0.7	1.8	0.2
310	16	20	0.9	3.8	0.1
310	16	20	0.9	2.4	0.2
335	16	22	1.4	4.9	0.2
335	16	22	1.4	3.1	0.4
355	16	22	1.8	6	0.4
355	16	22	1.8	3.7	0.6
385	16	24	2.6	15	0.6
385	16	24	2.6	8.3	1.0
450	10	24	4	23	1.1
450	10	24	4	17	1.7
540	10	26	12	39	1.4
540	10	26	12	22	3.0
600	10	28	17	45	2.9
600	10	28	17	32	4.0

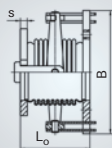
2) Available with other hole patterns / thicknesses on request. The overall length L0 may change then.

# ANGULAR EXPANSION JOINTS WITH PLAIN FIXED FLANGES

Type WFN



Type WFK



06

Nominal diameter	Nominal angular movement absorption	Type WFN 10... WFK 10...	Order No. standard version		WFN		WFK	
			WFN	WFK	overall length	weight approx.	overall length	weight approx.
DN	$2\alpha_N$	—	—	—	$L_0$	G	$L_0$	G
—	degree	—	—	—	mm	kg	mm	kg
350	17.0	.0350.170.0	442148	-	200	67	-	-
350	26.0	.0350.260.0	442149	441366	270	72	270	112
400	12.0	.0400.120.0	442150	-	220	89	-	-
400	26.0	.0400.260.0	442151	441367	370	105	370	159
450	13.0	.0450.130.0	442152	-	240	112	-	-
450	25.0	.0450.250.0	442153	441368	360	127	360	200
500	14.0	.0500.140.0	442154	-	250	149	-	-
500	25.0	.0500.250.0	442155	441369	380	171	380	270
600	12.0	.0600.120.0	442156	-	270	188	-	-
600	23.0	.0600.230.0	442157	441370	410	214	410	373

# SINGLE HINGE VERSION TYPE WFN 10 ... GIMBAL HINGE VERSION TYPE WFK 10 ...

## PN 10

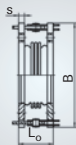
06

Max. width approx.	Flange <sup>2)</sup>		Spring rate		
	drilling DIN 1092	thickness	$c_r$	$c_{\alpha}$	$c_p$
B	PN	s	$c_r$	$c_{\alpha}$	$c_p$
mm	–	mm	Nm/bar	Nm/deg	Nm/deg bar
660	10	28	20	77	2.8
660	10	28	20	44	5.0
710	10	32	26	294	4.1
710	10	32	26	118	10.0
810	10	37	33	358	5.4
810	10	37	33	159	12.0
860	10	37	55	392	7.1
860	10	37	55	174	16.0
980	10	43	77	577	11.0
980	10	43	77	257	24.0

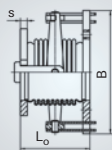
2) Available with other hole patterns / thicknesses on request. The overall length L0 may change then.

# ANGULAR EXPANSION JOINTS WITH PLAIN FIXED FLANGES

Type WFN



Type WFK



06

Nominal diameter	Nominal angular movement absorption	Type WFN 16... WFK 16...	Order No. standard version		WFN		WFK	
			WFN	WFK	overall length	weight approx.	overall length	weight approx.
DN	$2\alpha_N$	—	—	—	$L_0$	G	$L_0$	G
—	degree	—	—	—	mm	kg	mm	kg
50	25.0	.0050.250.0	442158	441371	130	10	130	14
50	34.0	.0050.340.0	442159	441372	160	10	160	14
65	25.0	.0065.250.0	442160	441373	140	11	140	16
65	34.0	.0065.340.0	442161	441374	180	12	180	17
80	23.0	.0080.230.0	442162	441375	150	13	150	18
80	32.0	.0080.320.0	442163	441376	180	13	180	19
100	24.0	.0100.240.0	442164	441377	160	15	160	22
100	33.0	.0100.330.0	442165	441378	190	16	190	23
125	24.0	.0125.240.0	442166	441379	170	19	170	28
125	33.0	.0125.330.0	442167	441380	220	20	220	29
150	22.0	.0150.220.0	442168	441381	180	23	180	33
150	31.0	.0150.310.0	442169	441382	230	25	230	34
200	22.0	.0200.220.0	442170	441383	190	42	190	64
200	31.0	.0200.310.0	442171	441384	250	45	250	66
250	14.0	.0250.140.0	442172	441385	210	52	210	81
250	23.0	.0250.230.0	442173	441386	280	59	280	88
300	15.0	.0300.150.0	442174	-	230	74	-	-
300	22.0	.0300.220.0	442175	441387	320	81	320	121
350	12.0	.0350.120.0	442176	-	210	96	-	-
350	19.0	.0350.190.0	442177	441388	300	104	300	159

# SINGLE HINGE VERSION TYPE WFN 16 ...

# GIMBAL HINGE VERSION TYPE WFK 16 ...

## PN 16

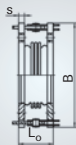
06

Max. width approx.	Flange <sup>2)</sup>		Spring rate		
	drilling DIN 1092	thickness	$c_r$	$c_{\alpha}$	$c_{\beta}$
B	PN	s	$c_r$	$c_{\alpha}$	$c_{\beta}$
mm	–	mm	Nm/bar	Nm/deg	Nm/deg bar
275	16	19	0.5	2.2	0.06
275	16	19	0.5	1.4	0.1
295	16	20	0.7	2.9	0.1
295	16	20	0.7	3.3	0.2
310	16	20	0.9	6.8	0.2
310	16	20	0.9	4.3	0.3
335	16	22	1.4	8.6	0.3
335	16	22	1.4	5.4	0.4
365	16	22	1.9	11	0.4
365	16	22	1.9	8	0.7
395	16	24	2.6	15	0.6
395	16	24	2.7	11	1.0
500	16	26	8	37	1.2
500	16	26	8	23	1.8
540	16	29	12	95	1.9
540	16	29	12	66	3.4
600	16	37	17	146	2.9
600	16	37	17	81	5.2
720	16	37	20	214	2.8
720	16	37	20	107	5.5

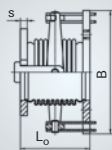
2) Available with other hole patterns / thicknesses on request. The overall length L0 may change then.

# ANGULAR EXPANSION JOINTS WITH PLAIN FIXED FLANGES

Type WFN



Type WFK



06

Nominal diameter	Nominal angular movement absorption	Type WFN 25... WFK 25...	Order No. standard version		WFN		WFK	
			WFN	WFK	overall length	weight approx.	overall length	weight approx.
DN	$2\alpha_n$	—	—	—	$L_0$	G	$L_0$	G
—	degree	—	—	—	mm	kg	mm	kg
50	22.0	.0050.220.0	442178	441389	140	10	140	15
50	30.0	.0050.300.0	442179	441390	170	11	170	16
65	23.0	.0065.230.0	442180	441391	150	13	150	17
65	30.0	.0065.300.0	442181	441392	180	13	180	18
80	22.0	.0080.220.0	442182	441393	150	15	150	21
80	28.0	.0080.280.0	442183	441394	180	16	180	22
100	22.0	.0100.220.0	442184	441395	160	19	160	27
100	27.0	.0100.270.0	442185	441396	180	20	180	28
125	22.0	.0125.220.0	442186	441397	180	25	180	34
125	29.0	.0125.290.0	442187	441398	230	26	230	35
150	20.0	.0150.200.0	442188	441399	180	42	180	61
150	27.0	.0150.270.0	442189	441400	230	45	230	62
200	14.0	.0200.140.0	442190	441401	200	51	200	77
200	22.0	.0200.220.0	442191	441402	270	57	270	83
250	14.0	.0250.140.0	442192	-	230	72	-	-
250	20.0	.0250.200.0	442193	441403	290	76	290	116
300	14.0	.0300.140.0	442194	-	250	118	-	-
300	19.0	.0300.190.0	442195	441404	340	129	340	202
350	11.0	.0350.110.0	442196	-	250	159	-	-
350	18.0	.0350.180.0	442197	441405	320	170	320	262

# SINGLE HINGE VERSION TYPE WFN 25 ... GIMBAL HINGE VERSION TYPE WFK 25 ...

## PN 25

06

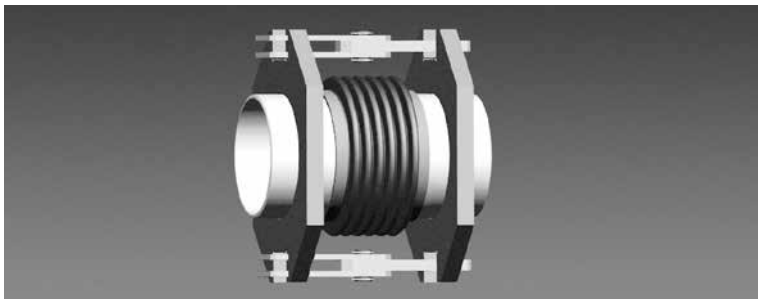
Max. width approx.	Flange <sup>2)</sup>		Spring rate		
	drilling DIN 1092	Flange <sup>2)</sup> thickness	$c_r$	$c_{\alpha}$	$c_{\beta}$
B	PN	s	$c_r$	$c_{\alpha}$	$c_{\beta}$
mm	–	mm	Nm/bar	Nm/deg	Nm/deg bar
275	40	20	0.5	4.0	0.07
275	40	20	0.5	2.5	0.1
295	40	22	0.7	5.2	0.1
295	40	22	0.7	3.3	0.2
310	40	24	0.9	8.1	0.2
310	40	24	0.9	5.8	0.2
340	40	24	1.4	10	0.3
340	40	24	1.4	7.4	0.4
365	40	26	1.9	18	0.4
365	40	26	1.9	12	0.7
460	40	28	4.8	26	0.6
460	40	28	4.8	16	1.0
500	25	32	8	83	1.2
500	25	32	8	56	2.1
570	25	37	12	145	2.0
570	25	37	12	91	3.2
670	25	43	23	186	3.0
670	25	43	23	103	5.4
750	25	47	27	339	3.2
750	25	47	27	193	5.6

2) Available with other hole patterns / thicknesses on request. The overall length L0 may change then.



# ANGULAR EXPANSION JOINTS WITH WELD ENDS TYPE WRN, WRK

06



## Type designation

The type designation consists of 2 parts

1. Type series, defined by 3 letters
2. Nominal size, defined by 10 digits

## Example

Type WRN: HYDRA single hinge angular expansion joint with weld ends

Type WRK: HYDRA gimbal hinge angular expansion joint with weld ends

## Standard version/materials:

Multi-ply bellow made of 1.4541

Weld ends up to DN 300: P 235 GH (1.0345)

Weld ends from DN 350: P 265 GH (1.0425)

Operating temperature: up to 400 °C

## Type designation (example)

WRN

Type

10

Nominal pressure  
(PN10)

0150

Nominal diameter  
(DN150)

240

Movement absorption,  
nominal  
( $2\alpha = \pm 12 = 24^\circ$ )

0

Inner sleeve  
(0 = without,  
1 = with)

## Order text according to guideline 2014/68/EU "Pressure Equipment Directive"

Please state the following with your order:

For standard versions

- Type designation or order number

With material variation

- Type designation
- Details of the materials

According to the Pressure Equipment Directive, the following information is required for testing and documentation:

06

Type of pressure equipment according to Art. 1 & 2:

- Vessel - volume V [l] \_\_\_\_\_
- Piping - nominal diameter DN \_\_\_\_\_

Medium property according to Art. 13:

- Group 1 – dangerous
- Group 2 – all other fluids

State of medium

- Gaseous or liquid if PD > 0.5 bar
- Liquid if PD ≤ 0.5 bar

Design data:

- Max. allowable pressure [bar] \_\_\_\_\_
- Max./min. allowable temperature [°C] \_\_\_\_\_
- Test pressure PT [bar] \_\_\_\_\_

Optional:

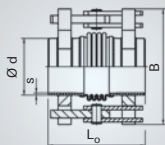
- Category \_\_\_\_\_

### Note

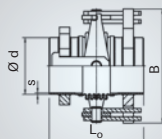
Tell us the dimensions that deviate from the standard and we customize the expansion joint to your specification.

# ANGULAR EXPANSION JOINTS WITH WELD ENDS

Type WRN



Type WRK



06

Nominal diameter	Nominal angular movement absorption	Type WRN 02... WRK 02...	Order No. standard version		WRN		WRK	
			WRN	WRK	overall length	weight approx.	overall length	weight approx.
DN	2α <sub>N</sub>	–	–	–	L <sub>o</sub>	G	L <sub>o</sub>	G
–	degree	–	–	–	mm	kg	mm	kg
400	10,0	.0400.100.0	441744	441436	290	32	290	47
400	20,0	.0400.200.0	441745	441437	350	35	350	50
400	28,0	.0400.280.0	441746	441438	410	37	410	52
450	9,9	.0450.099.0	441747	441439	290	37	290	55
450	19,0	.0450.190.0	441748	441440	355	41	355	58
450	26,0	.0450.260.0	441749	441441	420	43	420	61
500	11,0	.0500.110.0	441750	441442	320	44	320	67
500	20,0	.0500.200.0	441751	441443	385	48	385	71
500	30,0	.0500.300.0	441752	441444	475	53	475	76
600	10,0	.0600.100.0	441753	441445	345	64	345	99
600	22,0	.0600.220.0	441754	441446	450	70	450	105
600	29,0	.0600.290.0	441755	441447	550	76	550	111
700	9,1	.0700.091.0	441756	441448	395	92	395	158
700	17,0	.0700.170.0	441757	441449	475	99	475	164
700	25,0	.0700.250.0	441758	441450	615	110	615	175
800	8,4	.0800.084.0	441759	441451	440	126	440	219
800	18,0	.0800.180.0	441760	441452	555	136	555	228
800	26,0	.0800.260.0	441761	441453	670	156	670	249
900	7,4	.0900.074.0	441762	441454	445	146	445	266
900	14,0	.0900.140.0	441763	441455	530	155	530	275
900	20,0	.0900.200.0	441764	441456	680	169	680	289

# SINGLE HINGE VERSION TYPE WRN 02 ... GIMBAL HINGE VERSION TYPE WRK 02 ...

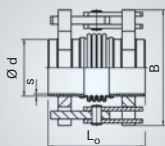
## PN 2.5

06

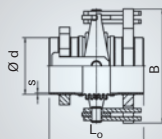
Max. width approx.	Weld end		Spring rate		
	outside diameter	wall thickness			
B	d	s	c <sub>r</sub>	c <sub>α</sub>	c <sub>β</sub>
mm	mm	mm	Nm/bar	Nm/deg	Nm/deg bar
595	406.4	8,8	14	142	2.6
595	406.4	8,8	14	71	5.3
595	406.4	8,8	14	47	7.9
655	457	6,0	18	165	3.5
655	457	6,0	18	82	7
655	457	6,0	18	55	11
715	508	6,0	23	179	4.5
715	508	6,0	23	89	9
715	508	6,0	23	54	15
815	610	6,0	32	254	7.3
815	610	6,0	32	109	17
815	610	6,0	32	69	27
970	711	8,0	78	326	11
970	711	8,0	78	162	21
970	711	8,0	78	89	39
1080	813	8,0	101	456	14
1080	813	8,0	101	196	33
1080	813	8,0	101	186	52
1200	914	8,0	128	628	19
1200	914	8,0	128	313	37
1200	914	8,0	128	170	68

# ANGULAR EXPANSION JOINTS WITH WELD ENDS

Type WRN



Type WRK



06

Nominal diameter	Nominal angular movement absorption	Type WRN 02... WRK 02...	Order No. standard version		WRN		WRK	
			WRN	WRK	overall length	weight approx.	overall length	weight approx.
DN	$2\alpha_N$	–	–	–	$L_o$	G	$L_o$	G
–	degree	–	–	–	mm	kg	mm	kg
1000	7,7	.1000.077.0	441765	441457	495	191	495	345
1000	14,0	.1000.140.0	441766	441458	590	200	590	355
1000	22,0	.1000.220.0	441767	441459	725	226	725	380
1200	6,5	.1200.065.0	441768	441460	535	284	535	567
1200	12,0	.1200.120.0	441769	441461	630	302	630	585
1200	18,0	.1200.180.0	441770	441462	755	326	755	609
1400	4,0	.1400.040.0	441771	-	565	396	-	-
1400	7,7	.1400.077.0	441772	441463	680	416	680	807
1400	12,0	.1400.120.0	441773	441464	850	469	850	860
1600	3,5	.1600.035.0	441774	-	565	523	-	-
1600	6,8	.1600.068.0	441775	441465	680	549	680	1161
1600	11,0	.1600.110.0	441776	441466	835	584	835	1195
1800	3,1	.1800.031.0	441777	-	565	575	-	-
1800	6,1	.1800.061.0	441778	-	680	603	-	-
1800	9,5	.1800.095.0	441779	441467	835	640	835	1430
2000	2,8	.2000.028.0	441780	-	615	773	-	-
2000	5,5	.2000.055.0	441781	-	730	803	-	-
2000	8,6	.2000.086.0	441782	441468	885	843	885	1846

# SINGLE HINGE VERSION TYPE WRN 02 ... GIMBAL HINGE VERSION TYPE WRK 02 ...

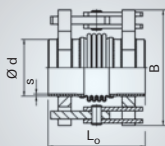
## PN 2.5

06

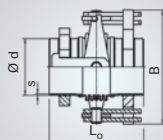
Max. width approx.	Weld end		Spring rate		
	outside diameter	wall thickness			
B	d	s	c <sub>r</sub>	c <sub>α</sub>	c <sub>β</sub>
mm	mm	mm	Nm/bar	Nm/deg	Nm/deg bar
1310	1016	8,0	157	814	24
1310	1016	8,0	157	408	49
1310	1016	8,0	158	367	84
1540	1220	10,0	296	1750	34
1540	1220	10,0	296	877	69
1540	1220	10,0	296	524	115
1740	1420	10,0	399	5560	56
1740	1420	10,0	399	2782	113
1740	1420	10,0	400	2516	195
1995	1620	10,0	646	8156	73
1995	1620	10,0	646	4078	146
1995	1620	10,0	646	2446	243
2185	1820	10,0	811	11440	92
2185	1820	10,0	811	5724	183
2185	1820	10,0	811	3433	305
2425	2020	10,0	996	15513	112
2425	2020	10,0	996	7752	225
2425	2020	10,0	996	4655	375

# ANGULAR EXPANSION JOINTS WITH WELD ENDS

Type WRN



Type WRK



06

Nominal diameter	Nominal angular movement absorption	Type WRN 06... WRK 06...	Order No. standard version		WRN		WRK	
			WRN	WRK	overall length	weight approx.	overall length	weight approx.
DN	$2\alpha_n$	—	—	—	$L_0$	G	$L_0$	G
—	degree	—	—	—	mm	kg	mm	kg
50	18,0	.0050.180.0	441798	441471	210	5	210	8
50	28,0	.0050.280.0	441799	441472	225	5	225	9
50	37,0	.0050.370.0	441800	441473	240	5	240	9
65	17,0	.0065.170.0	441801	441474	210	6	210	9
65	27,0	.0065.270.0	441802	441475	225	6	225	10
65	39,0	.0065.390.0	441803	441476	250	6	250	10
80	17,0	.0080.170.0	441804	441477	210	6	210	10
80	27,0	.0080.270.0	441805	441478	230	7	230	11
80	38,0	.0080.380.0	441806	441479	260	7	260	11
100	17,0	.0100.170.0	441807	441480	215	8	215	12
100	27,0	.0100.270.0	441808	441481	235	8	235	13
100	38,0	.0100.380.0	441809	441482	265	9	265	13
125	19,0	.0125.190.0	441810	441483	235	9	235	14
125	30,0	.0125.300.0	441811	441484	260	9	260	14
125	39,0	.0125.390.0	441812	441485	285	10	285	14
150	15,0	.0150.150.0	441813	441486	240	11	240	17
150	27,0	.0150.270.0	441814	441487	280	12	280	17
150	36,0	.0150.360.0	441815	441488	320	12	320	18
200	14,0	.0200.140.0	441816	441489	270	20	270	29
200	29,0	.0200.290.0	441817	441490	330	21	330	30
200	40,0	.0200.400.0	441818	441491	390	24	390	33
250	14,0	.0250.140.0	441819	441492	275	27	275	38
250	22,0	.0250.220.0	441820	441493	310	28	310	39
250	32,0	.0250.320.0	441821	441494	365	30	365	41

# SINGLE HINGE VERSION TYPE WRN 06 ... GIMBAL HINGE VERSION TYPE WRK 06 ...

## PN 6

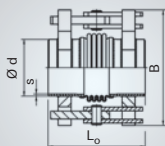
06

Max. width approx.	Weld end		Spring rate		
	outside diameter	wall thickness			
B	d	s	c <sub>r</sub>	c <sub>α</sub>	c <sub>β</sub>
mm	mm	mm	Nm/bar	Nm/deg	Nm/deg bar
195	60.3	2,9	0.5	2.2	0.04
195	60.3	2,9	0.5	1.3	0.06
195	60.3	2,9	0.5	1	0.08
215	76.1	2,9	0.7	3.2	0.05
215	76.1	2,9	0.7	1.9	0.09
215	76.1	2,9	0.7	1.2	0.1
230	88.9	3,2	0.9	3.9	0.08
230	88.9	3,2	0.9	2.3	0.1
230	88.9	3,2	0.9	1.5	0.2
265	114.3	3,6	1.4	5.5	0.1
265	114.3	3,6	1.4	3.3	0.2
265	114.3	3,6	1.4	2.1	0.4
285	139.7	4,0	1.9	5	0.2
285	139.7	4,0	1.9	3	0.4
285	139.7	4,0	1.9	2.1	0.5
325	168.3	4,0	2.6	14	0.3
325	168.3	4,0	2.6	7.2	0.6
325	168.3	4,0	2.6	4.7	1
385	219.1	4,5	4.3	22	0.6
385	219.1	4,5	4.3	9.5	1.4
385	219.1	4,5	4.4	12	2.2
445	273	5,0	6.7	52	1.1
445	273	5,0	6.7	31	1.8
445	273	5,0	6.7	20	2.8

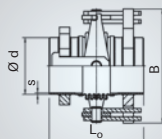


# ANGULAR EXPANSION JOINTS WITH WELD ENDS

Type WRN



Type WRK



06

Nominal diameter	Nominal angular movement absorption	Type WRN 06... WRK 06...	Order No. standard version		WRN		WRK	
			WRN	WRK	overall length	weight approx.	overall length	weight approx.
DN	2α <sub>N</sub>	–	–	–	L <sub>o</sub>	G	L <sub>o</sub>	G
–	degree	–	–	–	mm	kg	mm	kg
300	15,0	.0300.150.0	441822	441495	285	38	285	53
300	23,0	.0300.230.0	441823	441496	325	40	325	54
300	34,0	.0300.340.0	441824	441497	385	43	385	57
350	13,0	.0350.130.0	441825	441498	330	46	330	71
350	25,0	.0350.250.0	441826	441499	390	49	390	75
350	34,0	.0350.340.0	441827	441500	460	55	460	80
400	10,0	.0400.100.0	441828	441501	350	60	350	94
400	19,0	.0400.190.0	441829	441502	415	65	415	99
400	27,0	.0400.270.0	441830	441503	500	71	500	105
450	9,8	.0450.098.0	441831	441504	355	68	355	111
450	18,0	.0450.180.0	441832	441505	420	74	420	117
450	24,0	.0450.240.0	441833	441506	490	79	490	122
500	10,0	.0500.100.0	441834	441507	385	88	385	144
500	17,0	.0500.170.0	441835	441508	435	93	435	150
500	26,0	.0500.260.0	441836	441509	530	103	530	160
600	10,0	.0600.100.0	441837	441510	435	136	435	243
600	16,0	.0600.160.0	441838	441511	490	144	490	250
600	25,0	.0600.250.0	441839	441512	600	160	600	266
700	9,1	.0700.091.0	441840	-	475	195	-	-
700	17,0	.0700.170.0	441841	441513	555	209	555	357
700	24,0	.0700.240.0	441842	441514	655	238	655	385
800	8,4	.0800.084.0	441843	-	490	233	-	-
800	16,0	.0800.160.0	441844	441515	590	255	590	449
800	23,0	.0800.230.0	441845	441516	720	284	720	479

# SINGLE HINGE VERSION TYPE WRN 06 ... GIMBAL HINGE VERSION TYPE WRK 06 ...

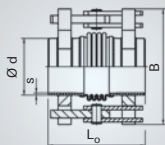
## PN 6

06

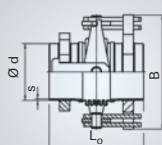
Max. width approx.	Weld end		Spring rate		
	outside diameter	wall thickness			
B	d	s	$c_r$	$c_{\alpha}$	$c_{\beta}$
mm	mm	mm	Nm/bar	Nm/deg	Nm/deg bar
495	323.9	5,6	9.3	63	1.6
495	323.9	5,6	9.3	38	2.7
495	323.9	5,6	9.3	24	4.3
580	355.6	8,0	20	87	2
580	355.6	8,0	20	43	4.1
580	355.6	8,0	20	35	6.4
640	406.4	8,8	26	194	2.8
640	406.4	8,8	26	97	5.6
640	406.4	8,8	26	58	9.3
700	457	8,0	33	248	3.7
700	457	8,0	33	124	7.3
700	457	8,0	33	83	11
750	508	8,0	41	347	4.9
750	508	8,0	41	208	8.2
750	508	8,0	41	116	15
900	610	8,0	77	493	7.9
900	610	8,0	77	296	13
900	610	8,0	77	164	24
1010	711	8,0	104	703	11
1010	711	8,0	104	352	21
1010	711	8,0	104	341	34
1120	813	10,0	135	1337	16
1120	813	10,0	135	668	32
1120	813	10,0	135	401	54

# ANGULAR EXPANSION JOINTS WITH WELD ENDS

Type WRN



Type WRK



06

Nominal diameter	Nominal angular movement absorption	Type WRN 06... WRK 06...	Order No. standard version		WRN		WRK	
			WRN	WRK	overall length	weight approx.	overall length	weight approx.
DN	$2\alpha_N$	-	-	-	$L_o$	G	$L_o$	G
-	degree	-	-	-	mm	kg	mm	kg
900	7,4	.0900.074.0	441846	-	580	379	-	-
900	14,0	.0900.140.0	441847	441517	680	408	680	714
900	20,0	.0900.200.0	441848	441518	810	445	810	751
1000	7,0	.1000.070.0	441849	-	640	434	-	-
1000	13,0	.1000.130.0	441850	441519	745	466	745	861
1000	19,0	.1000.190.0	441851	441520	885	507	885	902
1200	6,2	.1200.062.0	441852	-	640	579	-	-
1200	12,0	.1200.120.0	441853	441521	745	615	745	1184
1200	17,0	.1200.170.0	441854	441522	885	662	885	1231
1400	3,9	.1400.039.0	441855	-	620	741	-	-
1400	7,5	.1400.075.0	441856	-	740	778	-	-
1400	11,0	.1400.110.0	441857	441523	900	827	900	1747
1600	3,3	.1600.033.0	441858	-	720	1094	-	-
1600	6,3	.1600.063.0	441859	-	840	1138	-	-
1600	9,3	.1600.093.0	441860	441524	1000	1201	1000	2585
1800	2,9	.1800.029.0	441861	-	720	1211	-	-
1800	5,6	.1800.056.0	441862	-	840	1258	-	-
1800	8,5	.1800.085.0	441863	-	1000	1325	-	-
2000	2,7	.2000.027.0	441864	-	820	1877	-	-
2000	5,1	.2000.051.0	441865	-	940	1924	-	-
2000	7,8	.2000.078.0	441866	-	1100	2016	-	-

# SINGLE HINGE VERSION TYPE WRN 06 ... GIMBAL HINGE VERSION TYPE WRK 06 ...

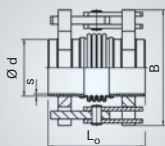
## PN 6

06

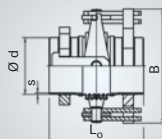
Max. width approx.	Weld end		Spring rate		
	outside diameter	wall thickness	$c_r$	$c_{\alpha}$	$c_p$
B	d	s	$c_r$	$c_{\alpha}$	$c_p$
mm	mm	mm	Nm/bar	Nm/deg	Nm/deg bar
1285	914	10,0	215	1896	21
1285	914	10,0	215	949	41
1285	914	10,0	215	569	69
1395	1016	10,0	264	2379	27
1395	1016	10,0	264	1189	54
1395	1016	10,0	264	713	90
1615	1220	10,0	370	3743	38
1615	1220	10,0	370	1872	75
1615	1220	10,0	370	1124	126
1840	1420	15,0	666	8394	58
1840	1420	15,0	666	4195	117
1840	1420	15,0	666	2516	195
2080	1620	15,0	1077	12301	76
2080	1620	15,0	1077	6150	151
2080	1620	15,0	1077	3691	252
2280	1820	15,0	1353	17255	95
2280	1820	15,0	1353	8628	190
2280	1820	15,0	1353	5178	316
2575	2020	15,0	2075	23378	116
2575	2020	15,0	2075	11694	233
2575	2020	15,0	2075	7018	388

# ANGULAR EXPANSION JOINTS WITH WELD ENDS

Type WRN



Type WRK



06

Nominal diameter	Nominal angular movement absorption	Type WRN 10... WRK 10...	Order No. standard version		WRN		WRK	
			WRN	WRK	overall length	weight approx.	overall length	weight approx.
DN	$2\alpha_n$	—	—	—	$L_0$	G	$L_0$	G
—	degree	—	—	—	mm	kg	mm	kg
50	17,0	.0050.170.0	441867	441525	210	5	210	8
50	27,0	.0050.270.0	441868	441526	225	5	225	9
50	37,0	.0050.370.0	441869	441527	250	6	250	9
65	16,0	.0065.160.0	441870	441528	210	6	210	9
65	29,0	.0065.290.0	441871	441529	235	6	235	10
65	37,0	.0065.370.0	441872	441530	260	7	260	10
80	16,0	.0080.160.0	441873	441531	215	7	215	10
80	25,0	.0080.250.0	441874	441532	235	7	235	11
80	36,0	.0080.360.0	441875	441533	265	7	265	11
100	17,0	.0100.170.0	441876	441534	215	8	215	12
100	26,0	.0100.260.0	441877	441535	240	8	240	13
100	36,0	.0100.360.0	441878	441536	275	9	275	13
125	16,0	.0125.160.0	441879	441537	260	11	260	16
125	25,0	.0125.250.0	441880	441538	285	12	285	17
125	32,0	.0125.320.0	441881	441539	315	12	315	17
150	15,0	.0150.150.0	441882	441540	260	14	260	21
150	27,0	.0150.270.0	441883	441541	305	15	305	22
150	36,0	.0150.360.0	441884	441542	350	17	350	23
200	14,0	.0200.140.0	441885	441543	270	24	270	33
200	26,0	.0200.260.0	441886	441544	320	25	320	34
200	35,0	.0200.350.0	441887	441545	370	28	370	37
250	14,0	.0250.140.0	441888	441546	295	41	295	59
250	21,0	.0250.210.0	441889	441547	330	43	330	61
250	30,0	.0250.300.0	441890	441548	390	47	390	66

# SINGLE HINGE VERSION TYPE WRN 10 ...

# GIMBAL HINGE VERSION TYPE WRK 10 ...

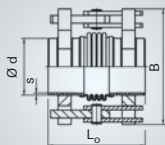
## PN 10

06

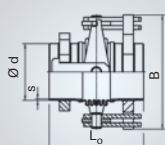
Max. width approx.	Weld end		Spring rate		
	outside diameter	wall thickness	$c_r$	$c_{\alpha}$	$c_{\beta}$
B	d	s	$c_r$	$c_{\alpha}$	$c_{\beta}$
mm	mm	mm	Nm/bar	Nm/deg	Nm/deg bar
195	60.3	2,9	0.5	2.2	0.04
195	60.3	2,9	0.5	1.3	0.06
195	60.3	2,9	0.5	0.8	0.1
215	76.1	2,9	0.7	3.2	0.05
215	76.1	2,9	0.7	1.6	0.1
215	76.1	2,9	0.7	1.8	0.2
230	88.9	3,2	0.9	6.3	0.09
230	88.9	3,2	0.9	3.8	0.1
230	88.9	3,2	0.9	2.4	0.2
265	114.3	3,6	1.4	8.2	0.1
265	114.3	3,6	1.4	4.9	0.2
265	114.3	3,6	1.4	3.1	0.4
285	139.7	4,0	1.8	10	0.2
285	139.7	4,0	1.8	6	0.4
285	139.7	4,0	1.8	4.3	0.5
325	168.3	4,0	2.6	25	0.3
325	168.3	4,0	2.6	13	0.7
325	168.3	4,0	2.6	8.4	1
385	219.1	4,5	4.4	39	0.6
385	219.1	4,5	4.4	20	1.3
385	219.1	4,5	4.4	15	2
480	273	5,0	12	52	1.1
480	273	5,0	12	31	1.8
480	273	5,0	12	22	3

# ANGULAR EXPANSION JOINTS WITH WELD ENDS

Type WRN



Type WRK



06

Nominal diameter	Nominal angular movement absorption	Type WRN 10... WRK 10...	Order No. standard version		WRN		WRK	
			WRN	WRK	overall length	weight approx.	overall length	weight approx.
DN	2α <sub>N</sub>	–	–	–	L <sub>o</sub>	G	L <sub>o</sub>	G
–	degree	–	–	–	mm	kg	mm	kg
300	15.0	.0300.150.0	441891	441549	330	58	330	86
300	23.0	.0300.230.0	441892	441550	370	61	370	89
300	29.0	.0300.290.0	441893	441551	410	63	410	91
350	13.0	.0350.130.0	441894	441552	350	53	350	86
350	21.0	.0350.210.0	441895	441553	395	56	395	89
350	26.0	.0350.260.0	441896	441554	435	59	435	92
400	9.4	.0400.094.0	441897	441555	355	71	355	116
400	18.0	.0400.180.0	441898	441556	430	79	430	124
400	26.0	.0400.260.0	441899	441557	520	90	520	135
450	9.7	.0450.097.0	441900	441558	420	112	420	166
450	16.0	.0450.160.0	441901	441559	470	118	470	173
450	23.0	.0450.230.0	441902	441560	545	128	545	182
500	10.0	.0500.100.0	441903	441561	470	150	470	243
500	16.0	.0500.160.0	441904	441562	525	158	525	251
500	24.0	.0500.240.0	441905	441563	605	171	605	264
600	9.4	.0600.094.0	441906	-	475	180	-	-
600	15.0	.0600.150.0	441907	441564	535	190	535	327
600	23.0	.0600.230.0	441908	441565	645	211	645	348
700	8.6	.0700.086.0	441909	-	525	292	-	-
700	16.0	.0700.160.0	441910	441568	620	320	685	694
700	22.0	.0700.220.0	441911	441567	715	348	715	580
800	8.4	.0800.084.0	441912	-	585	355	-	-
800	15.0	.0800.150.0	441913	441568	685	388	685	694
800	22.0	.0800.220.0	441914	441569	820	429	820	735

# SINGLE HINGE VERSION TYPE WRN 10 ... GIMBAL HINGE VERSION TYPE WRK 10 ...

## PN 10

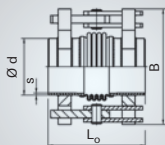
06

Max. width approx.	Weld end		Spring rate		
	outside diameter	wall thickness	$c_r$	$c_{\alpha}$	$c_{\beta}$
B	d	s	$c_r$	$c_{\alpha}$	$c_{\beta}$
mm	mm	mm	Nm/bar	Nm/deg	Nm/deg bar
540	323.9	5.6	17	76	1.7
540	323.9	5.6	17	45	2.9
540	323.9	5.6	17	32	4
580	355.6	8.0	20	104	2.1
580	355.6	8.0	20	62	3.6
580	355.6	8.0	20	45	5
640	406.4	8.8	26	397	3.1
640	406.4	8.8	26	198	6.1
640	406.4	8.8	26	119	10
740	457	8.0	33	482	4
740	457	8.0	33	289	6.7
740	457	8.0	33	181	11
790	508	10.0	55	526	5.4
790	508	10.0	55	316	8.9
790	508	10.0	55	197	14
900	610	10.0	77	775	8.2
900	610	10.0	77	465	14
900	610	10.0	77	259	24
1065	711	12.0	131	1381	12
1065	711	12.0	131	690	24
1065	711	12.0	131	461	36
1165	813	12.0	169	1794	17
1165	813	12.0	169	897	33
1165	813	12.0	169	538	56

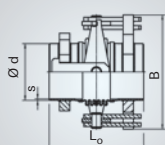


# ANGULAR EXPANSION JOINTS WITH WELD ENDS

Type WRN



Type WRK



06

Nominal diameter	Nominal angular movement absorption	Type WRN 10... WRK 10...	Order No. standard version		WRN		WRK	
			WRN	WRK	overall length	weight approx.	overall length	weight approx.
DN	$2\alpha_N$	–	–	–	$L_0$	G	$L_0$	G
–	degree	–	–	–	mm	kg	mm	kg
900	7.4	.0900.074.0	441915	-	635	469	-	-
900	14.0	.0900.140.0	441916	441570	735	505	735	905
900	2.0	.0900.200.0	441917	441571	870	552	870	952
1000	5.7	.1000.057.0	441918	-	745	689	-	-
1000	11.0	.1000.110.0	441919	441572	850	736	850	1338
1000	16.0	.1000.160.0	441920	441573	995	801	995	1403
1200	5.9	.1200.059.0	441921	-	750	885	-	-
1200	11.0	.1200.110.0	441922	-	860	942	-	-
1200	15.0	.1200.150.0	441923	441574	965	1000	965	1971
1400	3.7	.1400.037.0	441924	-	825	1413	-	-
1400	6.9	.1400.069.0	441925	-	950	1458	-	-
1400	9.9	.1400.099.0	441926	441575	1115	1551	1115	3168

# SINGLE HINGE VERSION TYPE WRN 10 ... GIMBAL HINGE VERSION TYPE WRK 10 ...

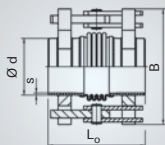
## PN 10

06

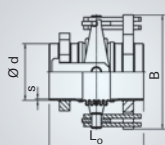
Max. width approx.	Weld end		Spring rate		
	outside diameter	wall thickness			
B	d	s	$c_r$	$c_{\alpha}$	$c_p$
mm	mm	mm	Nm/bar	Nm/deg	Nm/deg bar
1315	914	12.0	215	2542	21
1315	914	12.0	215	1272	43
1315	914	12.0	215	764	71
1450	1016	15.0	355	5007	28
1450	1016	15.0	355	2502	56
1450	1016	15.0	355	1502	93
1680	1220	15.0	617	5354	40
1680	1220	15.0	617	2677	80
1680	1220	15.0	617	1786	120
1975	1420	15.0	1041	11650	60
1975	1420	15.0	1041	5827	121
1975	1420	15.0	1041	3496	201

# ANGULAR EXPANSION JOINTS WITH WELD ENDS

Type WRN



Type WRK



Nominal diameter	Nominal angular movement absorption	Type WRN 16... WRK 16...	Order No. standard version		WRN		WRK	
			WRN	WRK	overall length	weight approx.	overall length	weight approx.
DN	$2\alpha_n$	—	—	—	$L_0$	G	$L_0$	G
—	degree	—	—	—	mm	kg	mm	kg
50	16.0	.0050.160.0	441927	441576	210	5	210	8
50	25.0	.0050.250.0	441928	441577	225	6	225	9
50	34.0	.0050.340.0	441929	441578	250	6	250	9
65	16.0	.0065.160.0	441930	441579	210	6	210	9
65	25.0	.0065.250.0	441931	441580	230	6	230	10
65	34.0	.0065.340.0	441932	441581	265	7	265	11
80	14.0	.0080.140.0	441933	441582	235	9	235	13
80	23.0	.0080.230.0	441934	441583	260	9	260	13
80	32.0	.0080.320.0	441935	441584	295	10	295	13
100	15.0	.0100.150.0	441936	441585	240	10	240	15
100	24.0	.0100.240.0	441937	441586	265	11	265	15
100	33.0	.0100.330.0	441938	441587	305	12	305	16
125	15.0	.0125.150.0	441939	441588	260	12	260	18
125	24.0	.0125.240.0	441940	441589	285	12	285	18
125	33.0	.0125.330.0	441941	441590	335	14	335	19
150	14.0	.0150.140.0	441942	441591	260	17	260	25
150	22.0	.0150.220.0	441943	441592	290	17	290	26
150	31.0	.0150.310.0	441944	441593	345	19	345	28
200	14.0	.0200.140.0	441945	441594	315	39	315	55
200	22.0	.0200.220.0	441946	441595	350	41	350	57
200	31.0	.0200.310.0	441947	441596	405	44	405	60

# SINGLE HINGE VERSION TYPE WRN 16 ... GIMBAL HINGE VERSION TYPE WRK 16 ...

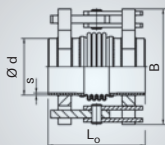
## PN 16

06

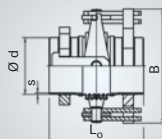
Max. width approx.	Weld end		Spring rate		
	outside diameter	wall thickness	$c_r$	$c_{\alpha}$	$c_{\beta}$
B	d	s	$c_r$	$c_{\alpha}$	$c_{\beta}$
mm	mm	mm	Nm/bar	Nm/deg	Nm/deg bar
195	60.3	2.9	0.5	3.7	0.04
195	60.3	2.9	0.5	2.2	0.06
195	60.3	2.9	0.5	1.4	0.1
215	76.1	2.9	0.7	4.9	0.06
215	76.1	2.9	0.7	2.9	0.1
215	76.1	2.9	0.7	3.3	0.2
230	88.9	3.2	0.9	12	0.09
230	88.9	3.2	0.9	6.9	0.2
230	88.9	3.2	0.9	4.3	0.3
265	114.3	3.6	1.4	15	0.2
265	114.3	3.6	1.4	8.8	0.3
265	114.3	3.6	1.4	5.5	0.4
285	139.7	4.0	1.9	18	0.2
285	139.7	4.0	1.9	11	0.4
285	139.7	4.0	1.9	8.1	0.7
325	168.3	4.0	2.6	25	0.3
325	168.3	4.0	2.6	15	0.6
325	168.3	4.0	2.7	11	1
420	219.1	4.5	7.9	63	0.7
420	219.1	4.5	7.9	38	1.2
420	219.1	4.5	7.9	24	1.8

# ANGULAR EXPANSION JOINTS WITH WELD ENDS

Type WRN



Type WRK



06

Nominal diameter	Nominal angular movement absorption	Type WRN 16... WRK 16...	Order No. standard version		WRN		WRK	
			WRN	WRK	overall length	weight approx.	overall length	weight approx.
DN	$2\alpha_N$	–	–	–	$L_o$	G	$L_o$	G
–	degree	–	–	–	mm	kg	mm	kg
250	9.1	.0250.091.0	441948	441597	320	48	320	73
250	16.0	.0250.160.0	441949	441598	375	51	375	76
250	23.0	.0250.230.0	441950	441599	430	57	430	82
300	9.6	.0300.096.0	441951	441600	350	67	350	102
300	15.0	.0300.150.0	441952	441601	390	71	390	106
300	22.0	.0300.220.0	441953	441602	470	78	470	113
350	8.8	.0350.088.0	441954	441603	410	83	410	125
350	14.0	.0350.140.0	441955	441604	450	87	450	128
350	20.0	.0350.200.0	441956	441605	530	94	530	136
400	9.3	.0400.093.0	441957	-	425	119	-	-
400	15.0	.0400.150.0	441958	441606	475	128	475	202
400	23.0	.0400.230.0	441959	441607	575	145	575	220
450	9.0	.0450.090.0	441960	-	425	134	-	-
450	14.0	.0450.140.0	441961	441608	475	144	475	239
450	22.0	.0450.220.0	441962	441609	575	163	575	259
500	9.9	.0500.099.0	441963	-	475	173	-	-
500	16.0	.0500.160.0	441964	441610	530	184	530	303
500	22.0	.0500.220.0	441965	441611	610	200	610	319
600	6.3	.0600.063.0	441966	-	520	259	-	-
600	12.0	.0600.120.0	441967	441612	610	283	610	487
600	16.0	.0600.160.0	441968	441613	695	308	695	512

# SINGLE HINGE VERSION TYPE WRN 16 ... GIMBAL HINGE VERSION TYPE WRK 16 ...

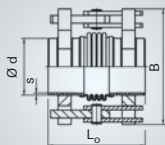
## PN 16

06

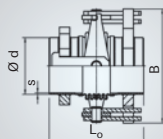
Max. width approx.	Weld end		Spring rate		
	outside diameter	wall thickness			
B	d	s	c <sub>r</sub>	c <sub>α</sub>	c <sub>β</sub>
mm	mm	mm	Nm/bar	Nm/deg	Nm/deg bar
480	273	5.0	12	160	1.1
480	273	5.0	12	80	2.2
480	273	5.0	12	67	3.4
540	323.9	5.6	17	246	1.7
540	323.9	5.6	17	147	2.9
540	323.9	5.6	17	82	5.2
620	355.6	8.0	20	288	2.1
620	355.6	8.0	20	173	3.4
620	355.6	8.0	20	96	6.2
680	406.4	8.8	35	517	3.3
680	406.4	8.8	35	310	5.6
680	406.4	8.8	35	172	10
740	457	8.0	44	654	4.2
740	457	8.0	44	392	7
740	457	8.0	44	218	13
790	508	10.0	55	715	5.6
790	508	10.0	55	429	9.3
790	508	10.0	55	268	15
945	610	12.0	97	2052	8.5
945	610	12.0	97	1026	17
945	610	12.0	97	684	25

# ANGULAR EXPANSION JOINTS WITH WELD ENDS

Type WRN



Type WRK



06

Nominal diameter	Nominal angular movement absorption	Type WRN 16... WRK 16...	Order No. standard version		WRN		WRK	
			WRN	WRK	overall length	weight approx.	overall length	weight approx.
DN	$2\alpha_N$	–	–	–	$L_o$	G	$L_o$	G
–	degree	–	–	–	mm	kg	mm	kg
700	6.3	.0700.063.0	441969	-	570	348	-	-
700	12.0	.0700.120.0	441970	-	665	377	-	-
700	16.0	.0700.160.0	441971	441614	755	406	755	694
800	6.0	.0800.060.0	441972	-	630	521	-	-
800	11.0	.0800.110.0	441973	-	725	557	-	-
800	15.0	.0800.150.0	441974	441615	820	595	820	1056
900	6.0	.0900.060.0	441975	-	735	792	-	-
900	11.0	.0900.110.0	441976	441616	835	841	835	1519
900	16.0	.0900.160.0	441977	441617	970	913	970	1591
1000	5.7	.1000.057.0	441978	-	755	880	-	-
1000	9.1	.1000.091.0	441979	-	830	925	-	-
1000	14.0	.1000.140.0	441980	441618	980	1015	980	1868

# SINGLE HINGE VERSION TYPE WRN 16 ... GIMBAL HINGE VERSION TYPE WRK 16 ...

## PN 16

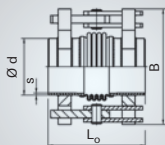
06

Max. width approx.	Weld end		Spring rate		
	outside diameter	wall thickness			
B	d	s	c <sub>r</sub>	c <sub>ci</sub>	c <sub>p</sub>
mm	mm	mm	Nm/bar	Nm/deg	Nm/deg bar
1085	711	12.0	131	2524	12
1085	711	12.0	131	1262	24
1085	711	12.0	131	841	35
1220	813	15.0	226	3410	16
1220	813	15.0	226	1705	32
1220	813	15.0	226	1136	47
1380	914	15.0	362	4707	21
1380	914	15.0	362	2352	43
1380	914	15.0	362	1411	72
1490	1016	15.0	445	6654	29
1490	1016	15.0	445	3994	49
1490	1016	15.0	445	2218	88

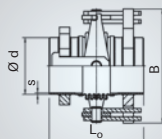


# ANGULAR EXPANSION JOINTS WITH WELD ENDS

Type WRN



Type WRK



06

Nominal diameter	Nominal angular movement absorption	Type WRN 25... WRK 25...	Order No. standard version		WRN		WRK	
			WRN	WRK	overall length	weight approx.	overall length	weight approx.
DN	$2\alpha_n$	—	—	—	$L_o$	G	$L_o$	G
—	degree	—	—	—	mm	kg	mm	kg
50	14.0	.0050.140.0	441981	441619	210	6	210	9
50	22.0	.0050.220.0	441982	441620	230	7	230	10
50	30.0	.0050.300.0	441983	441621	260	7	260	10
65	15.0	.0065.150.0	441984	441622	235	7	235	11
65	23.0	.0065.230.0	441985	441623	255	8	255	12
65	29.0	.0065.290.0	441986	441624	275	8	275	12
80	14.0	.0080.140.0	441987	441625	235	9	235	13
80	22.0	.0080.220.0	441988	441626	260	9	260	13
80	28.0	.0080.280.0	441989	441627	285	10	285	13
100	14.0	.0100.140.0	441990	441628	240	12	240	18
100	22.0	.0100.220.0	441991	441629	265	13	265	18
100	27.0	.0100.270.0	441992	441630	290	13	290	19
125	14.0	.0125.140.0	441993	441631	265	14	265	22
125	22.0	.0125.220.0	441994	441632	295	15	295	23
125	27.0	.0125.270.0	441995	441633	325	16	325	23
150	13.0	.0150.130.0	441996	441634	305	29	305	43
150	20.0	.0150.200.0	441997	441635	335	31	335	44
150	27.0	.0150.270.0	441998	441636	385	33	385	47
200	9.1	.0200.091.0	441999	441637	335	44	335	63
200	16.0	.0200.160.0	442000	441638	390	47	390	67
200	22.0	.0200.220.0	442001	441639	440	52	440	71
250	9.0	.0250.090.0	442002	441640	340	55	340	84
250	14.0	.0250.140.0	442003	441641	380	58	380	87
250	20.0	.0250.200.0	442004	441642	440	63	440	92

# SINGLE HINGE VERSION TYPE WRN 25 ... GIMBAL HINGE VERSION TYPE WRK 25 ...

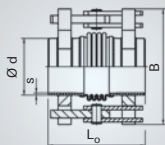
## PN 25

06

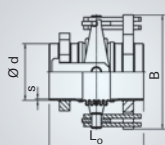
Max. width approx.	Weld end		Spring rate		
	outside diameter	wall thickness			
B	d	s	c <sub>r</sub>	c <sub>α</sub>	c <sub>β</sub>
mm	mm	mm	Nm/bar	Nm/deg	Nm/deg bar
195	60.3	2.9	0.5	6.9	0.04
195	60.3	2.9	0.5	4.2	0.07
195	60.3	2.9	0.5	2.6	0.1
215	76.1	2.9	0.7	8.8	0.07
215	76.1	2.9	0.7	5.3	0.1
215	76.1	2.9	0.7	3.8	0.2
230	88.9	3.2	0.9	14	0.1
230	88.9	3.2	0.9	8.3	0.2
230	88.9	3.2	0.9	5.9	0.2
265	114.3	3.6	1.4	18	0.2
265	114.3	3.6	1.4	11	0.3
265	114.3	3.6	1.4	7.5	0.4
285	139.7	4.0	1.9	31	0.3
285	139.7	4.0	1.9	19	0.4
285	139.7	4.0	1.9	13	0.6
360	168.3	4.0	4.8	44	0.4
360	168.3	4.0	4.8	26	0.6
360	168.3	4.0	4.8	16	1
420	219.1	4.5	8	140	0.7
420	219.1	4.5	8	70	1.4
420	219.1	4.5	8	57	2.1
480	273	5.0	12	245	1.2
480	273	5.0	12	147	2
480	273	5.0	12	92	3.2

# ANGULAR EXPANSION JOINTS WITH WELD ENDS

Type WRN



Type WRK



06

Nominal diameter	Nominal angular movement absorption	Type WRN 25... WRK 25...	Order No. standard version		WRN		WRK	
			WRN	WRK	overall length	weight approx.	overall length	weight approx.
DN	2α <sub>N</sub>	–	–	–	L <sub>o</sub>	G	L <sub>o</sub>	G
–	degree	–	–	–	mm	kg	mm	kg
300	8.7	.0300.087.0	442005	441643	410	105	410	161
300	14.0	.0300.140.0	442006	441644	455	110	455	166
300	18.0	.0300.180.0	442007	441645	520	118	520	173
350	8.8	.0350.088.0	442008	-	455	120	-	-
350	14.0	.0350.140.0	442009	441646	505	127	505	195
350	20.0	.0350.200.0	442010	441647	600	142	600	209
400	6.2	.0400.062.0	442011	-	460	138	-	-
400	12.0	.0400.120.0	442012	441648	535	151	535	244
400	16.0	.0400.160.0	442013	441649	605	164	605	256
450	6.3	.0450.063.0	442014	-	505	221	-	-
450	12.0	.0450.120.0	442015	441650	580	237	580	383
450	16.0	.0450.160.0	442016	441651	655	254	655	401
500	6.2	.0500.062.0	442017	-	525	253	-	-
500	10.0	.0500.100.0	442018	441652	585	270	585	450
500	16.0	.0500.160.0	442019	441653	705	304	705	484
600	6.3	.0600.063.0	442020	-	585	416	-	-
600	10.0	.0600.100.0	442021	-	645	438	-	-
600	15.0	.0600.150.0	442022	441654	770	484	770	792
700	5.9	.0700.059.0	442023	-	735	636	-	-
700	9.3	.0700.093.0	442024	-	800	655	-	-
700	14.0	.0700.140.0	442025	441655	930	716	930	1200

# SINGLE HINGE VERSION TYPE WRN 25 ... GIMBAL HINGE VERSION TYPE WRK 25 ...

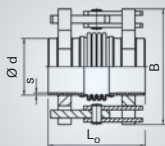
## PN 25

06

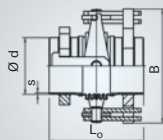
Max. width approx.	Weld end		Spring rate		
	outside diameter	wall thickness			
B	d	s	$c_r$	$c_{\alpha}$	$c_{\beta}$
mm	mm	mm	Nm/bar	Nm/deg	Nm/deg bar
580	323.9	5.6	23	313	1.8
580	323.9	5.6	23	188	3
580	323.9	5.6	23	118	4.8
620	355.6	8.0	27	458	2.4
620	355.6	8.0	27	275	4
620	355.6	8.0	27	153	7.2
680	406.4	10.0	35	1055	3.2
680	406.4	10.0	35	528	6.4
680	406.4	10.0	35	352	9.6
785	457	10.0	55	1336	4.2
785	457	10.0	55	668	8.4
785	457	10.0	55	445	13
845	508	12.0	69	1944	6
845	508	12.0	69	1166	10
845	508	12.0	69	648	18
1000	610	15.0	130	2543	9.1
1000	610	15.0	130	1526	15
1000	610	15.0	130	848	27
1150	711	15.0	219	3611	13
1150	711	15.0	219	2167	21
1150	711	15.0	219	1203	38

# ANGULAR EXPANSION JOINTS WITH WELD ENDS

Type WRN



Type WRK



06

Nominal diameter	Nominal angular movement absorption	Type WRN 40... WRK 40...	Order No. standard version		WRN		WRK	
			WRN	WRK	overall length	weight approx.	overall length	weight approx.
DN	$2\alpha_N$	—	—	—	$L_0$	G	$L_0$	G
—	degree	—	—	—	mm	kg	mm	kg
50	14.0	.0050.140.0	442026	441656	235	6	235	9
50	21.0	.0050.210.0	442027	441657	255	7	255	10
50	25.0	.0050.250.0	442028	441658	275	7	275	10
65	12.0	.0065.120.0	442029	441659	235	8	235	12
65	19.0	.0065.190.0	442030	441660	260	8	260	12
65	26.0	.0065.260.0	442031	441661	295	9	295	13
80	13.0	.0080.130.0	442032	441662	240	10	240	15
80	20.0	.0080.200.0	442033	441663	265	11	265	15
80	24.0	.0080.240.0	442034	441664	290	11	290	16
100	7.7	.0100.077.0	442035	441665	240	12	240	19
100	12.0	.0100.120.0	442036	441666	265	13	265	20
100	17.0	.0100.170.0	442037	441667	315	14	315	21
125	8.6	.0125.086.0	442038	441668	305	25	305	38
125	13.0	.0125.130.0	442039	441669	335	27	335	39
125	17.0	.0125.170.0	442040	441670	365	28	365	41
150	8.6	.0150.086.0	442041	441671	325	33	325	48
150	13.0	.0150.130.0	442042	441672	355	34	355	50
150	17.0	.0150.170.0	442043	441673	385	36	385	51
200	7.7	.0200.077.0	442044	441674	340	53	340	78
200	12.0	.0200.120.0	442045	441675	380	57	380	82
200	17.0	.0200.170.0	442046	441676	440	61	440	86

# SINGLE HINGE VERSION TYPE WRN 40 ... GIMBAL HINGE VERSION TYPE WRK 40 ...

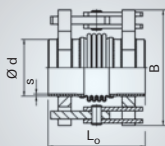
## PN 40

06

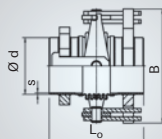
Max. width approx.	Weld end		Spring rate		
	outside diameter	wall thickness			
B	d	s	$c_r$	$c_{\alpha}$	$c_{\beta}$
mm	mm	mm	Nm/bar	Nm/deg	Nm/deg bar
195	60.3	2.9	0.5	8.7	0.05
195	60.3	2.9	0.5	5.2	0.08
195	60.3	2.9	0.5	3.7	0.1
215	76.1	2.9	0.7	16	0.08
215	76.1	2.9	0.7	9.6	0.1
215	76.1	2.9	0.7	6	0.2
230	88.9	3.2	0.9	19	0.1
230	88.9	3.2	0.9	11	0.2
230	88.9	3.2	0.9	8.2	0.2
265	114.3	3.6	1.4	45	0.2
265	114.3	3.6	1.4	27	0.3
265	114.3	3.6	1.4	22	0.5
330	139.7	4.0	3.4	72	0.3
330	139.7	4.0	3.4	43	0.4
330	139.7	4.0	3.4	31	0.6
360	168.3	4.0	4.8	96	0.4
360	168.3	4.0	4.8	58	0.6
360	168.3	4.0	4.8	41	0.9
420	219.1	4.5	8	253	0.8
420	219.1	4.5	8	152	1.3
420	219.1	4.5	8	95	2.1

# ANGULAR EXPANSION JOINTS WITH WELD ENDS

Type WRN



Type WRK



06

Nominal diameter	Nominal angular movement absorption	Type WRN 40... WRK 40...	Order No. standard version		WRN		WRK	
			WRN	WRK	overall length	weight approx.	overall length	weight approx.
DN	2α <sub>N</sub>	–	–	–	L <sub>0</sub>	G	L <sub>0</sub>	G
–	degree	–	–	–	mm	kg	mm	kg
250	7.8	.0250.078.0	442047	-	405	90	-	-
250	12.0	.0250.120.0	442048	441677	445	95	445	145
250	17.0	.0250.170.0	442049	441678	505	103	505	153
300	5.8	.0300.058.0	442050	-	415	122	-	-
300	9.2	.0300.092.0	442051	441679	460	129	460	199
300	14.0	.0300.140.0	442052	441680	550	142	550	212
350	6.1	.0350.061.0	442053	-	495	180	-	-
350	9.7	.0350.097.0	442054	441681	545	186	545	298
350	14.0	.0350.140.0	442055	441682	640	205	640	317
400	6.1	.0400.061.0	442056	-	505	207	-	-
400	9.7	.0400.097.0	442057	-	560	219	-	-
400	14.0	.0400.140.0	442058	441683	665	243	665	383
450	5.8	.0450.058.0	442059	-	520	255	-	-
450	9.3	.0450.093.0	442060	-	575	270	-	-
450	13.0	.0450.130.0	442061	441684	665	292	665	472
500	4.4	.0500.044.0	442062	-	615	389	-	-
500	7.0	.0500.070.0	442063	-	675	400	-	-
500	11.0	.0500.110.0	442064	441685	785	436	785	707

# SINGLE HINGE VERSION TYPE WRN 40 ... GIMBAL HINGE VERSION TYPE WRK 40 ...

## PN 40

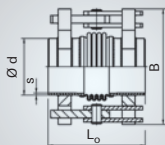
06

Max. width approx.	Weld end		Spring rate		
	outside diameter	wall thickness			
B	d	s	$c_r$	$c_{\alpha}$	$c_{\beta}$
mm	mm	mm	Nm/bar	Nm/deg	Nm/deg bar
520	273	6.3	16	338	1.3
520	273	6.3	16	203	2.1
520	273	6.3	16	127	3.3
580	323.9	7.1	23	833	1.9
580	323.9	7.1	23	500	3.2
580	323.9	7.1	23	278	5.7
675	355.6	8.0	34	884	2.4
675	355.6	8.0	34	530	4
675	355.6	8.0	34	295	7.2
725	406.4	10.0	44	1154	3.5
725	406.4	10.0	44	692	5.8
725	406.4	10.0	44	385	10
815	457	10.0	56	1717	4.7
815	457	10.0	56	1030	7.9
815	457	10.0	56	644	13
890	508	12.0	91	3287	5.8
890	508	12.0	91	1972	9.6
890	508	12.0	91	1095	17

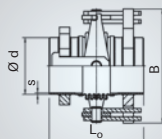


# ANGULAR EXPANSION JOINTS WITH WELD ENDS

Type WRN



Type WRK



Nominal diameter	Nominal angular movement absorption	Type WRN 63... WRK 63...	Order No. standard version		WRN		WRK	
			WRN	WRK	overall length	weight approx.	overall length	weight approx.
DN	$2\alpha_N$	—	—	—	$L_0$	G	$L_0$	G
—	degree	—	—	—	mm	kg	mm	kg
50	8.9	.0050.089.0	442065	441686	235	8	235	11
50	13.0	.0050.130.0	442066	441687	255	8	255	11
50	16.0	.0050.160.0	442067	441688	275	8	275	11
65	8.6	.0065.086.0	442068	441689	235	9	235	13
65	13.0	.0065.130.0	442069	441690	260	10	260	14
65	17.0	.0065.170.0	442070	441691	295	10	295	14
80	8.2	.0080.082.0	442071	441692	255	12	255	17
80	13.0	.0080.130.0	442072	441693	280	12	280	17
80	16.0	.0080.160.0	442073	441694	305	13	305	18
100	6.6	.0100.066.0	442074	441695	285	25	285	36
100	10.0	.0100.100.0	442075	441696	310	26	310	37
100	14.0	.0100.140.0	442076	441697	350	28	350	39
125	8.4	.0125.084.0	442077	441698	330	31	330	45
125	11.0	.0125.110.0	442078	441699	345	31	345	45
125	16.0	.0125.160.0	442079	441700	395	34	395	48
150	7.1	.0150.071.0	442080	441701	360	43	360	61
150	11.0	.0150.110.0	442081	441702	395	45	395	63
150	14.0	.0150.140.0	442082	441703	430	47	430	65
200	5.3	.0200.053.0	442083	441704	405	86	405	126
200	9.9	.0200.099.0	442084	441705	465	93	465	133
200	13.0	.0200.130.0	442085	441706	525	100	525	140

# SINGLE HINGE VERSION TYPE WRN 63 ... GIMBAL HINGE VERSION TYPE WRK 63 ...

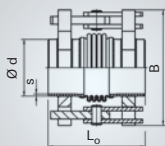
## PN 63

06

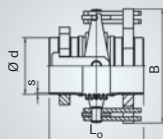
Max. width approx.	Weld end		Spring rate		
	outside diameter	wall thickness	$c_r$	$c_{\alpha}$	$c_{\beta}$
B	d	s	$c_r$	$c_{\alpha}$	$c_{\beta}$
mm	mm	mm	Nm/bar	Nm/deg	Nm/deg bar
195	60.3	2.9	0.5	16	0.04
195	60.3	2.9	0.5	9.5	0.07
195	60.3	2.9	0.5	6.8	0.1
215	76.1	3.2	0.7	28	0.07
215	76.1	3.2	0.7	17	0.1
215	76.1	3.2	0.7	11	0.2
230	88.9	4.0	0.9	37	0.1
230	88.9	4.0	0.9	22	0.2
230	88.9	4.0	0.9	16	0.2
300	114.3	4.5	2.5	86	0.2
300	114.3	4.5	2.5	52	0.3
300	114.3	4.5	2.5	32	0.4
330	139.7	6.3	3.4	90	0.3
330	139.7	6.3	3.4	68	0.4
330	139.7	6.3	3.4	39	0.7
360	168.3	5.6	4.9	178	0.5
360	168.3	5.6	4.9	107	0.8
360	168.3	5.6	4.9	76	1.1
460	219.1	8.0	11	515	0.8
460	219.1	8.0	11	258	1.6
460	219.1	8.0	11	172	2.4

# ANGULAR EXPANSION JOINTS WITH WELD ENDS

Type WRN



Type WRK



06

Nominal diameter	Nominal angular movement absorption	Type WRN 63... WRK 63...	Order No. standard version		WRN		WRK	
			WRN	WRK	overall length	weight approx.	overall length	weight approx.
DN	$2\alpha_N$	–	–	–	$L_o$	G	$L_o$	G
–	degree	–	–	–	mm	kg	mm	kg
250	5.1	.0250.051.0	442086	-	490	135	-	-
250	8.1	.0250.081.0	442087	441707	535	141	535	204
250	12.0	.0250.120.0	442088	441708	625	154	625	216
300	5.3	.0300.053.0	442089	-	500	195	-	-
300	8.2	.0300.082.0	442090	441709	550	202	550	310
300	11.0	.0300.110.0	442091	441710	625	216	625	324
350	5.2	.0350.052.0	442092	-	570	238	-	-
350	9.7	.0350.097.0	442093	441711	655	259	655	394
350	13.0	.0350.130.0	442094	441712	740	279	740	414
400	3.9	.0400.039.0	442095	-	605	347	-	-
400	7.2	.0400.072.0	442096	-	685	360	-	-
400	9.9	.0400.099.0	442097	441713	790	392	790	603

# SINGLE HINGE VERSION TYPE WRN 63 ... GIMBAL HINGE VERSION TYPE WRK 63 ...

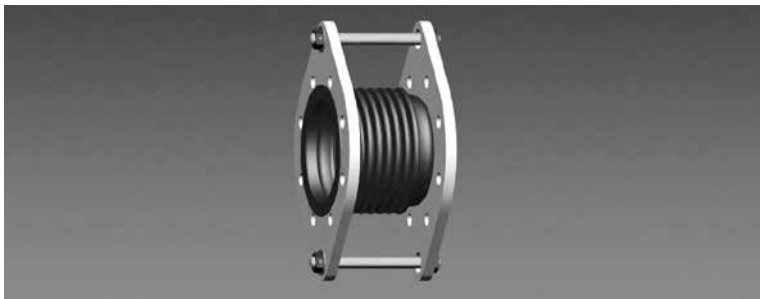
## PN 63

06

Max. width approx.	Weld end		Spring rate		
	outside diameter	wall thickness			
B	d	s	$c_r$	$c_{c1}$	$c_p$
mm	mm	mm	Nm/bar	Nm/deg	Nm/deg bar
575	273	8.8	16	788	1.4
575	273	8.8	16	473	2.3
575	273	8.8	16	263	4.1
625	323.9	10.0	29	955	2.1
625	323.9	10.0	29	573	3.5
625	323.9	10.0	29	358	5.5
695	355.6	12.0	35	1448	2.9
695	355.6	12.0	35	724	5.9
695	355.6	12.0	35	483	8.8
780	406.4	15.0	59	2378	3.5
780	406.4	15.0	59	1189	7
780	406.4	15.0	59	956	11

# LATERAL EXPANSION JOINTS WITH FLANGES TYPE LBR, LFR

06



## Type designation

The type designation consists of 2 parts

1. Type series, defined by 3 letters
2. Nominal size, defined by 10 digits

## Example

Type LBR: HYDRA lateral expansion joint with loose flanges, for movement in all planes

Type LFR: HYDRA lateral expansion joint with plain fixed flanges, for movement in all planes

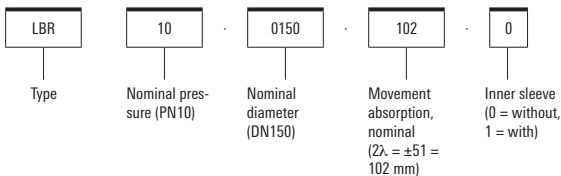
## Standard version/materials:

Multi-ply bellows made of 1.4541

Flange made of P265GH (1.0425)

Operating temperature: up to 400 °C

## Type designation (example)



## Order text according to guideline 2014/68/EU "Pressure Equipment Directive"

Please state the following with your order:

For standard versions

- Type designation or order number

With material variation

- Type designation
- Details of the materials

According to the Pressure Equipment Directive, the following information is required for testing and documentation:

06

Type of pressure equipment according to Art. 1 & 2:

- Vessel - volume V [l] \_\_\_\_\_
- Piping - nominal diameter DN \_\_\_\_\_

Medium property according to Art. 13:

- Group 1 – dangerous
- Group 2 – all other fluids

State of medium

- Gaseous or liquid if PD > 0.5 bar
- Liquid if PD ≤ 0.5 bar

Design data:

- Max. allowable pressure [bar] \_\_\_\_\_
- Max./min. allowable temperature [°C] \_\_\_\_\_
- Test pressure PT [bar] \_\_\_\_\_

Optional:

- Category \_\_\_\_\_

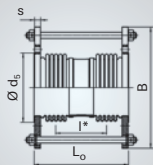
### Note

Tell us the dimensions that deviate from the standard and we customize the expansion joint to your specification.

On request, flanges can also be supplied with other hole patterns / flange sheet thicknesses. In this case, the specified overall length L0 may change.

# LATERAL EXPANSION JOINTS WITH LOOSE FLANGES, FOR MOVEMENT IN ALL PLANES

Type LBR



06

Nominal diameter	Nominal lateral movement absorption	Type LBR 06...	Order No. standard version	Overall length	Weight approx.	Max. width approx.
DN	$2\lambda_{N1}$	–	–	$L_o$	G	B
–	mm	–	–	mm	kg	mm
50	51	.0050.051.0	439805	250	6	240
50	102	.0050.102.0	439806	360	7	240
50	154	.0050.154.0	439807	470	7	240
50	196	.0050.196.0	439808	560	10	240
65	53	.0065.053.0	439809	260	7	260
65	104	.0065.104.0	439810	370	8	260
65	151	.0065.151.0	439811	470	8	260
65	204	.0065.204.0	439812	580	9	260
80	53	.0080.053.0	439813	275	10	290
80	102	.0080.102.0	439814	385	11	290
80	154	.0080.154.0	439815	495	11	290
80	201	.0080.201.0	439816	595	12	290
100	52	.0100.052.0	439817	275	11	310
100	103	.0100.103.0	439818	385	12	310
100	151	.0100.151.0	439819	485	13	310
100	204	.0100.204.0	439820	595	13	310
125	51	.0125.051.0	439821	310	15	340
125	103	.0125.103.0	439822	450	15	340
125	153	.0125.153.0	439823	580	21	340
125	203	.0125.203.0	439824	710	23	340

# TYPE LBR 06 ... PN 6

06

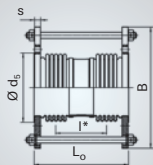
Centre-to-centre distance of bellows	Flange <sup>2)</sup>			Spring rate		
	drilling as per DIN 1092	rim diameter	thickness	$c_1$	$c_2$	$c_p$
I*	PN	$d_5$	s	$c_1$	$c_2$	$c_p$
mm	mm	mm	cm <sup>2</sup>	N/bar	N/mm	N/mm bar
136	6	90	16	4.9	13	0
246	6	90	16	3.6	4.1	0
356	6	90	16	2.8	2	0
445	6	90	16	2.4	1.3	0
141	6	107	16	7.2	16	0
251	6	107	16	5.3	5.2	0
351	6	107	16	4.3	2.7	0
461	6	107	16	3.5	1.5	0
146	6	122	18	8.9	19	0
256	6	122	18	6.6	6.5	0
366	6	122	18	5.3	3.2	0
466	6	122	18	4.5	2	0
141	6	147	18	14	27	0
251	6	147	18	10	8.8	0
351	6	147	18	8.3	4.5	0
461	6	147	18	6.9	2.6	0
167	6	178	20	16	30	0
307	6	178	20	12	9	0
437	6	178	20	9.3	4.5	0
567	6	178	20	7.7	2.7	0

2) Available with other hole patterns / thicknesses on request. The overall length L0 may change then.



# LATERAL EXPANSION JOINTS WITH LOOSE FLANGES, FOR MOVEMENT IN ALL PLANES

Type LBR



06

Nominal diameter	Nominal lateral movement absorption	Type LBR 06...	Order No. standard version	Overall length	Weight approx.	Max. width approx.
DN	$2\lambda_{N1}$	–	–	$L_o$	G	B
–	mm	–	–	mm	kg	mm
150	53	.0150.053.0	439825	330	18	365
150	101	.0150.101.0	439826	450	19	365
150	144	.0150.144.0	439827	570	24	365
150	195	.0150.195.0	439828	690	27	365
200	51	.0200.051.0	439829	345	25	420
200	100	.0200.100.0	439830	475	27	420
200	153	.0200.153.0	439831	605	37	420
200	198	.0200.198.0	439832	730	42	420
250	50	.0250.050.0	439833	365	35	503
250	102	.0250.102.0	439834	505	38	503
250	153	.0250.153.0	439835	635	53	503
250	212	.0250.212.0	439836	805	62	503
300	50	.0300.050.0	439837	380	48	600
300	101	.0300.101.0	439838	540	52	600
300	152	.0300.152.0	439839	690	56	600
300	196	.0300.196.0	439840	840	88	600
300	296	.0300.296.0	439841	1140	111	600
350	52	.0350.052.0	439842	410	61	650
350	102	.0350.102.0	439843	580	65	650
350	148	.0350.148.0	439844	755	89	650
350	195	.0350.195.0	439845	905	98	650
350	300	.0350.300.0	439846	1255	121	650

# TYPE LBR 06 ... PN 6

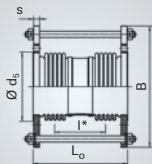
06

Centre-to-centre distance of bellows	Flange <sup>2)</sup>			Spring rate		
	drilling as per DIN 1092	rim diameter	thickness	$c_1$	$c_2$	$c_p$
I*	PN	$d_5$	s	$c_1$	$c_2$	$c_p$
mm	mm	mm	cm <sup>2</sup>	N/bar	N/mm	N/mm bar
166	6	202	20	22	58	0
286	6	202	20	17	20	0
406	6	202	20	14	10	0
526	6	202	20	11	6.1	0
166	6	258	22	42	89	0
296	6	258	22	32	30	0
426	6	258	22	26	15	0
535	6	258	22	22	8.6	0
171	6	312	24	80	111	0
311	6	312	24	61	36	0
441	6	312	24	50	18	0
590	6	312	24	41	9.5	0
191	6	365	24	155	140	0
351	6	365	24	115	43	0
501	6	365	24	93	21	0
630	6	365	24	78	13	0
930	6	365	24	59	5.9	0
215	6	410	26	173	153	0
385	6	410	26	129	49	0
534	6	410	26	103	24	0
684	6	410	26	87	15	0
1034	6	410	26	65	6.6	0

2) Available with other hole patterns / thicknesses on request. The overall length L0 may change then.

# LATERAL EXPANSION JOINTS WITH LOOSE FLANGES, FOR MOVEMENT IN ALL PLANES

Type LBR



06

Nominal diameter	Nominal lateral movement absorption	Type LBR 06...	Order No. standard version	Overall length	Weight approx.	Max. width approx.
DN	$2\lambda_{N1}$	–	–	$L_0$	G	B
–	mm	–	–	mm	kg	mm
400	51	.0400.051.0	439847	465	80	724
400	100	.0400.100.0	439848	665	103	724
400	158	.0400.158.0	439849	865	118	724
400	200	.0400.200.0	439850	1015	129	724
400	294	.0400.294.0	439851	1415	160	724
450	50	.0450.050.0	439852	475	89	779
450	97	.0450.097.0	439853	675	114	779
450	152	.0450.152.0	439854	875	131	779
450	192	.0450.192.0	439855	1025	144	779
450	289	.0450.289.0	439856	1390	179	779
500	52	.0500.052.0	439857	495	123	865
500	104	.0500.104.0	439858	710	153	865
500	147	.0500.147.0	439859	860	168	865
500	207	.0500.207.0	439860	1060	188	865
500	289	.0500.289.0	439861	1360	217	865

# TYPE LBR 06 ... PN 6

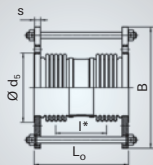
06

Centre-to-centre distance of bellows	Flange <sup>2)</sup>			Spring rate		
	drilling as per DIN 1092	rim diameter	thickness	$c_r$	$c_s$	$c_p$
I*	PN	$d_s$	s	$c_r$	$c_s$	$c_p$
mm	mm	mm	cm <sup>2</sup>	N/bar	N/mm	N/mm bar
231	6	465	28	251	232	0
410	6	465	28	187	69	0
610	6	465	28	149	33	0
760	6	465	28	130	21	0
1160	6	465	28	96	9.5	0
236	6	520	28	315	282	0
415	6	520	28	234	86	0
615	6	520	28	187	41	0
765	6	520	28	160	27	0
1120	6	520	28	122	17	0
236	6	570	32	424	389	0
425	6	570	32	313	113	0
575	6	570	32	263	64	0
775	6	570	32	219	36	0
1075	6	570	32	175	19	0

2) Available with other hole patterns / thicknesses on request. The overall length L0 may change then.

# LATERAL EXPANSION JOINTS WITH LOOSE FLANGES, FOR MOVEMENT IN ALL PLANES

Type LBR



06

Nominal diameter	Nominal lateral movement absorption	Type LBR 10...	Order No. standard version	Overall length	Weight approx.	Max. width approx.
DN	$2\lambda_{N1}$	—	—	$L_o$	G	B
—	mm	—	—	mm	kg	mm
50	51	.0050.051.0	439862	260	9	265
50	102	.0050.102.0	439863	370	10	265
50	146	.0050.146.0	439864	465	12	265
50	202	.0050.202.0	439865	615	13	265
65	53	.0065.053.0	439866	270	11	285
65	104	.0065.104.0	439867	380	11	285
65	146	.0065.146.0	439868	480	12	285
65	201	.0065.201.0	439869	630	13	285
80	53	.0080.053.0	439870	300	13	300
80	101	.0080.101.0	439871	420	14	300
80	151	.0080.151.0	439872	540	15	300
80	202	.0080.202.0	439873	660	15	300
100	50	.0100.050.0	439874	290	14	320
100	100	.0100.100.0	439875	420	15	320
100	146	.0100.146.0	439876	550	16	320
100	203	.0100.203.0	439877	730	22	320
125	50	.0125.050.0	439878	315	19	350
125	100	.0125.100.0	439879	435	20	350
125	153	.0125.153.0	439880	555	24	350
125	200	.0125.200.0	439881	665	25	350

# TYPE LBR 10 ... PN 10

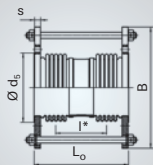
06

Centre-to-centre distance of bellows	Flange <sup>2)</sup>			Spring rate		
	drilling as per DIN 1092	rim diameter	thickness			
I*	PN	d <sub>5</sub>	s	c <sub>r</sub>	c <sub>i</sub>	c <sub>p</sub>
mm	mm	mm	cm <sup>2</sup>	N/bar	N/mm	N/mm bar
136	10	92	19	4.7	13	0
246	10	92	19	3.5	4.1	0
345	10	92	19	2.8	2.1	0
495	10	92	19	2.2	1	0
141	10	107	20	6.9	16	0
251	10	107	20	5.2	5.2	0
351	10	107	20	4.2	2.7	0
501	10	107	20	3.3	1.3	0
161	10	122	20	8.2	29	0
281	10	122	20	6.1	9.7	0
401	10	122	20	4.9	4.8	0
521	10	122	20	4.1	2.9	0
159	10	147	22	13	27	0
289	10	147	22	9.4	8.3	0
419	10	147	22	7.4	4	0
599	10	147	22	5.7	1.9	0
151	10	178	22	16	50	0
271	10	178	22	12	16	0
391	10	178	22	9.9	7.9	0
501	10	178	22	8.3	4.8	0

2) Available with other hole patterns / thicknesses on request. The overall length L0 may change then.

# LATERAL EXPANSION JOINTS WITH LOOSE FLANGES, FOR MOVEMENT IN ALL PLANES

Type LBR



06

Nominal diameter	Nominal lateral movement absorption	Type LBR 10...	Order No. standard version	Overall length	Weight approx.	Max. width approx.
DN	$2\lambda_{N1}$	—	—	$L_o$	G	B
—	mm	—	—	mm	kg	mm
150	51	.0150.051.0	439882	340	25	385
150	102	.0150.102.0	439883	470	27	385
150	145	.0150.145.0	439884	590	33	385
150	195	.0150.195.0	439885	710	36	385
200	52	.0200.052.0	439886	365	34	468
200	100	.0200.100.0	439887	515	37	468
200	153	.0200.153.0	439888	675	50	468
200	206	.0200.206.0	439889	855	58	468
250	52	.0250.052.0	439890	395	48	555
250	101	.0250.101.0	439891	555	63	555
250	152	.0250.152.0	439892	715	72	555
250	198	.0250.198.0	439893	885	82	555
300	51	.0300.051.0	439894	405	66	629
300	102	.0300.102.0	439895	565	72	629
300	145	.0300.145.0	439896	715	97	629
300	196	.0300.196.0	439897	865	109	629
300	292	.0300.292.0	439898	1165	133	629
350	50	.0350.050.0	439899	420	81	689
350	100	.0350.100.0	439900	590	87	689
350	149	.0350.149.0	439901	775	111	689
350	195	.0350.195.0	439902	925	121	689
350	296	.0350.296.0	439903	1275	145	689

# TYPE LBR 10 ... PN 10

06

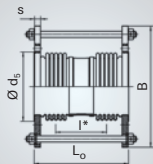
Centre-to-centre distance of bellows	Flange <sup>2)</sup>			Spring rate		
	drilling as per DIN 1092	rim diameter	thickness	$c_1$	$c_2$	$c_p$
I*	PN	$d_5$	s	$c_1$	$c_2$	$c_p$
mm	mm	mm	cm <sup>2</sup>	N/bar	N/mm	N/mm bar
161	10	208	24	26	74	0
291	10	208	24	20	24	0
411	10	208	24	16	12	0
531	10	208	24	14	7.3	0
199	10	258	24	54	92	0
349	10	258	24	40	31	0
509	10	258	24	32	15	0
668	10	258	24	26	8	0
207	10	320	26	110	112	0
367	10	320	26	82	37	0
527	10	320	26	66	18	0
676	10	320	26	54	10	0
199	10	370	28	181	202	0
359	10	370	28	138	65	0
488	10	370	28	115	32	0
638	10	370	28	96	19	0
938	10	370	28	73	9.2	0
213	10	410	28	207	242	0
383	10	410	28	160	78	0
542	10	410	28	127	36	0
692	10	410	28	108	23	0
1042	10	410	28	81	10	0

2) Available with other hole patterns / thicknesses on request. The overall length L0 may change then.



# LATERAL EXPANSION JOINTS WITH LOOSE FLANGES, FOR MOVEMENT IN ALL PLANES

Type LBR



06

Nominal diameter	Nominal lateral movement absorption	Type LBR 10...	Order No. standard version	Overall length	Weight approx.	Max. width approx.
DN	$2\lambda_{N1}$	–	–	$L_o$	G	B
–	mm	–	–	mm	kg	mm
400	51	.0400.051.0	439904	515	136	785
400	106	.0400.106.0	439905	760	164	785
400	146	.0400.146.0	439906	910	177	785
400	200	.0400.200.0	439907	1110	193	785
400	287	.0400.287.0	439908	1460	222	785
450	51	.0450.051.0	439909	505	160	756
450	98	.0450.098.0	439910	710	196	756
450	153	.0450.153.0	439911	910	221	756
450	195	.0450.195.0	439912	1060	239	756
450	285	.0450.285.0	439913	1410	282	756
500	51	.0500.051.0	439914	510	182	808
500	105	.0500.105.0	439915	735	224	808
500	148	.0500.148.0	439916	885	244	808
500	207	.0500.207.0	439917	1085	270	808
500	306	.0500.306.0	439918	1485	323	808

# TYPE LBR 10 ... PN 10

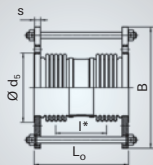
06

Centre-to-centre distance of bellows	Flange <sup>2)</sup>			Spring rate		
	drilling as per DIN 1092	rim diameter	thickness			
I*	PN	d <sub>5</sub>	s	c <sub>r</sub>	c <sub>i</sub>	c <sub>p</sub>
mm	mm	mm	cm <sup>2</sup>	N/bar	N/mm	N/mm bar
251	10	465	37	266	398	0
470	10	465	37	193	108	0
620	10	465	37	163	64	0
820	10	465	37	137	38	0
1170	10	465	37	108	19	0
246	10	520	32	297	500	0
425	10	520	32	225	159	0
625	10	520	32	181	77	0
775	10	520	32	159	51	0
1125	10	520	32	121	25	0
236	10	570	34	367	581	0
435	10	570	34	271	163	0
585	10	570	34	227	94	0
785	10	570	34	189	54	0
1185	10	570	34	142	24	0

2) Available with other hole patterns / thicknesses on request. The overall length L0 may change then.

# LATERAL EXPANSION JOINTS WITH LOOSE FLANGES, FOR MOVEMENT IN ALL PLANES

Type LBR



06

Nominal diameter	Nominal lateral movement absorption	Type LBR 16...	Order No. standard version	Overall length	Weight approx.	Max. width approx.
DN	$2\lambda_{N1}$	–	–	$L_o$	G	B
–	mm	–	–	mm	kg	mm
50	50	.0050.050.0	439919	280	10	265
50	103	.0050.103.0	439920	410	10	265
50	149	.0050.149.0	439921	530	13	265
50	199	.0050.199.0	439922	680	14	265
65	53	.0065.053.0	439923	290	12	285
65	104	.0065.104.0	439924	410	12	285
65	145	.0065.145.0	439925	520	13	285
65	198	.0065.198.0	439926	680	14	285
80	51	.0080.051.0	439927	300	13	300
80	102	.0080.102.0	439928	430	15	300
80	150	.0080.150.0	439929	550	15	300
80	205	.0080.205.0	439930	720	20	300
100	50	.0100.050.0	439931	310	16	320
100	103	.0100.103.0	439932	460	17	320
100	145	.0100.145.0	439933	590	18	320
100	202	.0100.202.0	439934	790	24	320
125	53	.0125.053.0	439935	345	21	350
125	102	.0125.102.0	439936	475	23	350
125	151	.0125.151.0	439937	595	27	350
125	196	.0125.196.0	439938	715	29	350

# TYPE LBR 16 ... PN 16

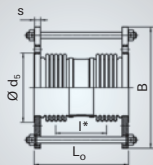
06

Centre-to-centre distance of bellows	Flange <sup>2)</sup>			Spring rate		
	drilling as per DIN 1092	rim diameter	thickness			
I*	PN	d <sub>5</sub>	s	c <sub>r</sub>	c <sub>i</sub>	c <sub>p</sub>
mm	mm	mm	cm <sup>2</sup>	N/bar	N/mm	N/mm bar
151	16	92	19	4.5	20	0
281	16	92	19	3.2	5.8	0
400	16	92	19	2.6	2.9	0
550	16	92	19	2	1.5	0
156	16	107	20	6.6	24	0
276	16	107	20	4.9	7.7	0
386	16	107	20	3.9	4	0
546	16	107	20	3.1	2	0
161	16	122	20	8.3	34	0
291	16	122	20	6.1	11	0
411	16	122	20	4.8	5.5	0
581	16	122	20	3.8	2.8	0
173	16	147	22	12	40	0
323	16	147	22	8.7	12	0
453	16	147	22	6.9	6	0
653	16	147	22	5.3	2.9	0
171	16	178	22	18	67	0
301	16	178	22	14	23	0
421	16	178	22	11	12	0
541	16	178	22	9.5	7.1	0

2) Available with other hole patterns / thicknesses on request. The overall length L0 may change then.

# LATERAL EXPANSION JOINTS WITH LOOSE FLANGES, FOR MOVEMENT IN ALL PLANES

Type LBR



06

Nominal diameter	Nominal lateral movement absorption	Type LBR 16...	Order No. standard version	Overall length	Weight approx.	Max. width approx.
DN	$2\lambda_{N1}$	—	—	$L_o$	G	B
—	mm	—	—	mm	kg	mm
150	53	.0150.053.0	439939	360	30	413
150	100	.0150.100.0	439940	490	32	413
150	147	.0150.147.0	439941	630	38	413
150	190	.0150.190.0	439942	760	42	413
200	50	.0200.050.0	439943	365	43	500
200	100	.0200.100.0	439944	525	47	500
200	150	.0200.150.0	439945	675	60	500
200	200	.0200.200.0	439946	865	69	500
250	52	.0250.052.0	439947	465	71	589
250	103	.0250.103.0	439948	685	92	589
250	154	.0250.154.0	439949	885	104	589
250	207	.0250.207.0	439950	1135	120	589
300	50	.0300.050.0	439951	500	111	680
300	95	.0300.095.0	439952	670	125	680
300	145	.0300.145.0	439953	870	143	680
300	196	.0300.196.0	439954	1120	164	680
300	296	.0300.296.0	439955	1620	206	680
350	51	.0350.051.0	439956	520	151	667
350	100	.0350.100.0	439957	720	172	667
350	149	.0350.149.0	439958	920	192	667
350	199	.0350.199.0	439959	1170	218	667
350	306	.0350.306.0	439960	1720	274	667

# TYPE LBR 16 ... PN 16

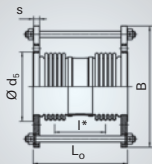
06

Centre-to-centre distance of bellows	Flange <sup>2)</sup>			Spring rate		
	drilling as per DIN 1092	rim diameter	thickness			
I*	PN	d <sub>5</sub>	s	c <sub>1</sub>	c <sub>2</sub>	c <sub>p</sub>
mm	mm	mm	cm <sup>2</sup>	N/bar	N/mm	N/mm bar
181	16	208	24	33	85	0
311	16	208	24	25	30	0
451	16	208	24	20	14	0
581	16	208	24	17	8.7	0
193	16	258	26	75	137	0
353	16	258	26	55	42	0
503	16	258	26	45	21	0
672	16	258	26	36	11	0
246	16	320	32	117	216	0
445	16	320	32	85	62	0
645	16	320	32	68	31	0
895	16	320	32	55	16	0
235	16	375	37	176	236	0
405	16	375	37	136	89	0
605	16	375	37	109	42	0
855	16	375	37	88	22	0
1355	16	375	37	63	8.8	0
260	16	410	32	182	280	0
460	16	410	32	138	99	0
660	16	410	32	111	50	0
910	16	410	32	88	27	0
1460	16	410	32	62	11	0

2) Available with other hole patterns / thicknesses on request. The overall length L0 may change then.

# LATERAL EXPANSION JOINTS WITH LOOSE FLANGES, FOR MOVEMENT IN ALL PLANES

Type LBR



06

Nominal diameter	Nominal lateral movement absorption	Type LBR 16...	Order No. standard version	Overall length	Weight approx.	Max. width approx.
DN	$2\lambda_{N1}$	–	–	$L_o$	G	B
–	mm	–	–	mm	kg	mm
400	52	.0400.052.0	439961	555	185	723
400	94	.0400.094.0	439962	725	205	723
400	147	.0400.147.0	439963	925	227	723
400	200	.0400.200.0	439964	1125	249	723
400	309	.0400.309.0	439965	1625	305	723
450	50	.0450.050.0	439966	560	247	815
450	104	.0450.104.0	439967	780	276	815
450	155	.0450.155.0	439968	980	303	815
450	203	.0450.203.0	439969	1180	330	815
450	296	.0450.296.0	439970	1630	389	815

# TYPE LBR 16 ... PN 16

06

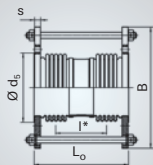
Centre-to-centre distance of bellows	Flange <sup>2)</sup>			Spring rate		
	drilling as per DIN 1092	rim diameter	thickness			
I*	PN	d <sub>5</sub>	s	c <sub>r</sub>	c <sub>s</sub>	c <sub>p</sub>
mm	mm	mm	cm <sup>2</sup>	N/bar	N/mm	N/mm bar
260	16	465	34	224	407	0
430	16	465	34	176	166	0
630	16	465	34	142	81	0
830	16	465	34	119	48	0
1330	16	465	34	85	19	0
260	16	520	37	307	516	0
480	16	520	37	233	171	0
680	16	520	37	192	89	0
880	16	520	37	163	54	0
1330	16	520	37	122	24	0

2) Available with other hole patterns / thicknesses on request. The overall length L0 may change then.



# LATERAL EXPANSION JOINTS WITH LOOSE FLANGES, FOR MOVEMENT IN ALL PLANES

Type LBR



06

Nominal diameter	Nominal lateral movement absorption	Type LBR 25...	Order No. standard version	Overall length	Weight approx.	Max. width approx.
DN	$2\lambda_{N1}$	–	–	$L_o$	G	B
–	mm	–	–	mm	kg	mm
50	50	.0050.050.0	439971	290	10	265
50	98	.0050.098.0	439972	420	11	265
50	148	.0050.148.0	439973	590	14	265
50	205	.0050.205.0	439974	790	15	265
65	51	.0065.051.0	439975	315	13	285
65	99	.0065.099.0	439976	465	14	285
65	153	.0065.153.0	439977	665	15	285
65	195	.0065.195.0	439978	825	20	285
80	52	.0080.052.0	439979	330	16	300
80	103	.0080.103.0	439980	470	20	300
80	155	.0080.155.0	439981	640	22	300
80	193	.0080.193.0	439982	780	23	300
100	50	.0100.050.0	439983	340	21	335
100	101	.0100.101.0	439984	510	26	335
100	145	.0100.145.0	439985	670	28	335
100	192	.0100.192.0	439986	855	32	335
125	51	.0125.051.0	439987	360	30	398
125	102	.0125.102.0	439988	520	32	398
125	153	.0125.153.0	439989	710	39	398
125	196	.0125.196.0	439990	895	43	398

# TYPE LBR 25 ... PN 25

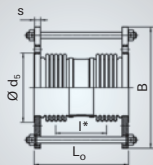
06

Centre-to-centre distance of bellows	Flange <sup>2)</sup>			Spring rate		
	drilling as per DIN 1092	rim diameter	thickness	$c_1$	$c_2$	$c_p$
I*	PN	$d_5$	s	$c_1$	$c_2$	$c_p$
mm	mm	mm	cm <sup>2</sup>	N/bar	N/mm	N/mm bar
151	25	92	20	4.4	23	0
286	25	92	20	3.2	7	0
455	25	92	20	2.4	2.8	0
655	25	92	20	1.8	1.4	0
185	25	107	22	6.3	26	0
335	25	107	22	4.4	8	0
535	25	107	22	3.2	3.1	0
695	25	107	22	2.6	1.9	0
176	25	122	24	7.8	39	0
316	25	122	24	5.7	13	0
486	25	122	24	4.3	5.4	0
626	25	122	24	3.6	3.3	0
197	25	147	24	14	54	0
367	25	147	24	9.7	16	0
527	25	147	24	7.6	7.8	0
712	25	147	24	6.1	4.3	0
195	25	178	26	23	67	0
355	25	178	26	17	21	0
545	25	178	26	13	8.8	0
714	25	178	26	10	4.9	0

2) Available with other hole patterns / thicknesses on request. The overall length L0 may change then.

# LATERAL EXPANSION JOINTS WITH LOOSE FLANGES, FOR MOVEMENT IN ALL PLANES

Type LBR



06

Nominal diameter	Nominal lateral movement absorption	Type LBR 25...	Order No. standard version	Overall length	Weight approx.	Max. width approx.
DN	$2\lambda_{N1}$	–	–	$L_o$	G	B
–	mm	–	–	mm	kg	mm
150	51	.0150.051.0	439991	375	40	460
150	102	.0150.102.0	439992	545	44	460
150	146	.0150.146.0	439993	745	54	460
150	194	.0150.194.0	439994	950	60	460
200	50	.0200.050.0	439995	445	66	544
200	101	.0200.101.0	439996	645	80	544
200	155	.0200.155.0	439997	915	93	544
200	195	.0200.195.0	439998	1115	103	544
250	51	.0250.051.0	439999	480	122	578
250	101	.0250.101.0	440000	700	147	578
250	149	.0250.149.0	440001	950	166	578
250	204	.0250.204.0	440002	1250	190	578
300	61	.0300.061.0	440003	620	170	634
300	110	.0300.110.0	440004	845	193	634
300	150	.0300.150.0	440005	1045	212	634
300	200	.0300.200.0	440006	1345	240	634
300	302	.0300.302.0	440007	1945	298	634
350	50	.0350.050.0	440008	550	237	735
350	100	.0350.100.0	440009	760	262	735
350	145	.0350.145.0	440010	960	285	735
350	190	.0350.190.0	440011	1210	313	735
350	291	.0350.291.0	440012	1760	375	735

# TYPE LBR 25 ... PN 25

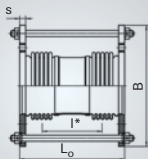
06

Centre-to-centre distance of bellows	Flange <sup>2)</sup>			Spring rate		
	drilling as per DIN 1092	rim diameter	thickness			
I*	PN	d <sub>5</sub>	s	c <sub>1</sub>	c <sub>2</sub>	c <sub>p</sub>
mm	mm	mm	cm <sup>2</sup>	N/bar	N/mm	N/mm bar
205	25	208	28	44	85	0
375	25	208	28	33	26	0
575	25	208	28	25	11	0
764	25	208	28	20	6.1	0
241	25	258	32	79	190	0
441	25	258	32	59	59	0
690	25	258	32	44	23	0
890	25	258	32	36	14	0
251	25	320	35	113	250	0
450	25	320	35	83	74	0
700	25	320	35	64	32	0
1000	25	320	35	50	16	0
340	25	375	38	131	213	0
565	25	375	38	99	83	0
765	25	375	38	82	46	0
1065	25	375	38	65	24	0
1665	25	375	38	46	10	0
260	25	410	42	194	363	0
470	25	410	42	147	125	0
670	25	410	42	120	64	0
920	25	410	42	99	35	0
1470	25	410	42	70	14	0

2) Available with other hole patterns / thicknesses on request. The overall length L0 may change then.

# LATERAL EXPANSION JOINTS WITH PLAIN FIXED FLANGES, FOR MOVEMENT IN ALL PLANES

Type LFR



06

Nominal diameter	Nominal lateral movement absorption	Type LFR 06...	Order No. standard version	Overall length	Weight approx.	Max. width approx.
DN	$2\lambda_{N1}$	–	–	$L_0$	G	B
–	mm	–	–	mm	kg	mm
50	51	.0050.051.0	440013	265	6	240
50	102	.0050.102.0	440014	375	7	240
50	154	.0050.154.0	440015	485	7	240
50	196	.0050.196.0	440016	575	10	240
65	53	.0065.053.0	440017	275	8	260
65	104	.0065.104.0	440018	385	8	260
65	151	.0065.151.0	440019	485	8	260
65	204	.0065.204.0	440020	595	9	260
80	53	.0080.053.0	440021	285	10	290
80	102	.0080.102.0	440022	395	11	290
80	154	.0080.154.0	440023	505	11	290
80	201	.0080.201.0	440024	605	12	290
100	52	.0100.052.0	440025	285	11	310
100	103	.0100.103.0	440026	395	13	310
100	151	.0100.151.0	440027	495	13	310
100	204	.0100.204.0	440028	605	13	310
125	51	.0125.051.0	440029	320	16	340
125	103	.0125.103.0	440030	460	16	340
125	153	.0125.153.0	440031	590	16	340
125	203	.0125.203.0	440032	720	23	340

# TYPE LFR 06 ... PN 6

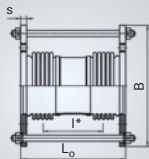
06

Centre-to-centre distance of bellows	Flange <sup>2)</sup>		Spring rate		
	drilling DIN 1092	thickness	$c_1$	$c_2$	$c_3$
$l^*$	PN	s	$c_1$	$c_2$	$c_3$
mm	mm	cm <sup>2</sup>	N/bar	N/mm	N/mm bar
136	6	16	4.6	13	0
246	6	16	3.4	4.1	0
356	6	16	2.7	2	0
445	6	16	2.4	1.3	0
141	6	16	6.7	16	0
251	6	16	5	5.2	0
351	6	16	4.1	2.7	0
461	6	16	3.4	1.5	0
146	6	18	8.4	19	0
256	6	18	6.3	6.5	0
366	6	18	5.1	3.2	0
466	6	18	4.3	2	0
141	6	18	13	27	0
251	6	18	9.8	8.8	0
351	6	18	8	4.5	0
461	6	18	6.7	2.6	0
167	6	20	16	30	0
307	6	20	12	9	0
437	6	20	9.2	4.5	0
567	6	20	7.6	2.7	0

2) Available with other hole patterns / thicknesses on request. The overall length L0 may change then.

# LATERAL EXPANSION JOINTS WITH PLAIN FIXED FLANGES, FOR MOVEMENT IN ALL PLANES

Type LFR



06

Nominal diameter	Nominal lateral movement absorption	Type LFR 06...	Order No. standard version	Overall length	Weight approx.	Max. width approx.
DN	$2\lambda_{N1}$	–	–	$L_0$	G	B
–	mm	–	–	mm	kg	mm
150	53	.0150.053.0	440033	340	19	365
150	101	.0150.101.0	440034	460	19	365
150	151	.0150.151.0	440035	580	21	365
150	202	.0150.202.0	440036	700	27	365
200	51	.0200.051.0	440037	350	26	420
200	100	.0200.100.0	440038	480	27	420
200	153	.0200.153.0	440039	610	29	420
200	198	.0200.198.0	440040	740	43	420
250	50	.0250.050.0	440041	375	36	503
250	102	.0250.102.0	440042	515	39	503
250	153	.0250.153.0	440043	645	41	503
250	212	.0250.212.0	440044	810	63	503
300	50	.0300.050.0	440045	385	50	600
300	101	.0300.101.0	440046	545	54	600
300	152	.0300.152.0	440047	695	58	600
300	196	.0300.196.0	440048	845	90	600
300	296	.0300.296.0	440049	1145	113	600
350	52	.0350.052.0	440050	415	63	650
350	102	.0350.102.0	440051	585	67	650
350	148	.0350.148.0	440052	755	89	650
350	195	.0350.195.0	440053	905	99	650
350	300	.0350.300.0	440054	1255	122	650

# TYPE LFR 06 ... PN 6

06

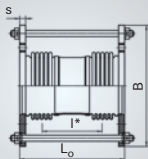
Centre-to-centre distance of bellows	Flange <sup>2)</sup>		Spring rate		
	drilling DIN 1092	thickness	$c_1$	$c_2$	$c_3$
I*	PN	s	$c_1$	$c_2$	$c_3$
mm	mm	cm <sup>2</sup>	N/bar	N/mm	N/mm bar
166	6	20	22	58	0
286	6	20	17	20	0
406	6	20	13	10	0
526	6	20	11	6.1	0
166	6	22	41	89	0
296	6	22	32	30	0
426	6	22	26	14	0
535	6	22	22	8.6	0
171	6	24	80	111	0
311	6	24	61	36	0
441	6	24	50	18	0
590	6	24	41	9.5	0
191	6	24	155	140	0
351	6	24	115	43	0
501	6	24	93	21	0
630	6	24	77	13	0
930	6	24	59	5.9	0
215	6	26	173	153	0
385	6	26	129	49	0
534	6	26	102	24	0
684	6	26	87	15	0
1034	6	26	64	6.6	0

2) Available with other hole patterns / thicknesses on request. The overall length L0 may change then.



# LATERAL EXPANSION JOINTS WITH PLAIN FIXED FLANGES, FOR MOVEMENT IN ALL PLANES

Type LFR



06

Nominal diameter	Nominal lateral movement absorption	Type LFR 06...	Order No. standard version	Overall length	Weight approx.	Max. width approx.
DN	$2\lambda_{N1}$	–	–	$L_0$	G	B
–	mm	–	–	mm	kg	mm
400	51	.0400.051.0	440055	460	83	724
400	100	.0400.100.0	440056	665	103	724
400	158	.0400.158.0	440057	865	119	724
400	200	.0400.200.0	440058	1015	131	724
400	294	.0400.294.0	440059	1415	162	724
450	50	.0450.050.0	440060	470	92	779
450	97	.0450.097.0	440061	675	115	779
450	152	.0450.152.0	440062	875	132	779
450	192	.0450.192.0	440063	1025	145	779
450	289	.0450.289.0	440064	1385	180	779
500	52	.0500.052.0	440065	490	127	865
500	104	.0500.104.0	440066	705	153	865
500	147	.0500.147.0	440067	855	168	865
500	207	.0500.207.0	440068	1055	188	865
500	289	.0500.289.0	440069	1355	218	865

# TYPE LFR 06 ... PN 6

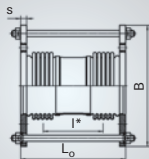
06

Centre-to-centre distance of bellows	Flange <sup>2)</sup>		Spring rate		
	drilling DIN 1092	thickness	$c_1$	$c_2$	$c_3$
I*	PN	s	$c_1$	$c_2$	$c_3$
mm	mm	cm <sup>2</sup>	N/bar	N/mm	N/mm bar
231	6	28	251	232	0
410	6	28	187	69	0
610	6	28	149	33	0
760	6	28	130	21	0
1160	6	28	96	9.5	0
236	6	28	315	282	0
415	6	28	234	86	0
615	6	28	187	41	0
765	6	28	160	27	0
1120	6	28	122	17	0
236	6	32	424	389	0
425	6	32	313	113	0
575	6	32	268	64	0
775	6	32	223	36	0
1075	6	32	178	19	0

2) Available with other hole patterns / thicknesses on request. The overall length L0 may change then.

# LATERAL EXPANSION JOINTS WITH PLAIN FIXED FLANGES, FOR MOVEMENT IN ALL PLANES

Type LFR



06

Nominal diameter	Nominal lateral movement absorption	Type LFR 10...	Order No. standard version	Overall length	Weight approx.	Max. width approx.
DN	$2\lambda_{N1}$	–	–	$L_o$	G	B
–	mm	–	–	mm	kg	mm
50	51	.0050.051.0	440070	270	9	265
50	102	.0050.102.0	440071	380	10	265
50	146	.0050.146.0	440072	475	12	265
50	202	.0050.202.0	440073	625	13	265
65	53	.0065.053.0	440074	280	11	285
65	104	.0065.104.0	440075	390	12	285
65	146	.0065.146.0	440076	490	12	285
65	201	.0065.201.0	440077	640	14	285
80	53	.0080.053.0	440078	310	14	300
80	101	.0080.101.0	440079	430	14	300
80	151	.0080.151.0	440080	550	15	300
80	202	.0080.202.0	440081	670	16	300
100	50	.0100.050.0	440082	300	14	320
100	100	.0100.100.0	440083	430	16	320
100	146	.0100.146.0	440084	560	16	320
100	203	.0100.203.0	440085	740	22	320
125	50	.0125.050.0	440086	320	19	350
125	100	.0125.100.0	440087	440	20	350
125	153	.0125.153.0	440088	560	21	350
125	200	.0125.200.0	440089	670	23	350

# TYPE LFR 10 ... PN 10

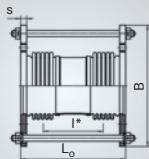
06

Centre-to-centre distance of bellows	Flange <sup>2)</sup>		Spring rate		
	drilling DIN 1092	thickness	$c_1$	$c_2$	$c_3$
$l^*$	PN	s	$c_1$	$c_2$	$c_3$
mm	mm	cm <sup>2</sup>	N/bar	N/mm	N/mm bar
136	16	19	4.6	13	0
246	16	19	3.4	4.1	0
345	16	19	2.8	2.1	0
495	16	19	2.2	1	0
141	16	20	6.7	16	0
251	16	20	5	5.2	0
351	16	20	4.1	2.7	0
501	16	20	3.2	1.3	0
161	16	20	8	29	0
281	16	20	6	9.7	0
401	16	20	4.8	4.8	0
521	16	20	4	2.9	0
159	16	22	13	27	0
289	16	22	9.2	8.3	0
419	16	22	7.2	4	0
599	16	22	5.6	1.9	0
151	16	22	16	50	0
271	16	22	12	16	0
391	16	22	9.7	7.9	0
501	16	22	8.2	4.8	0

2) Available with other hole patterns / thicknesses on request. The overall length L0 may change then.

# LATERAL EXPANSION JOINTS WITH PLAIN FIXED FLANGES, FOR MOVEMENT IN ALL PLANES

Type LFR



06

Nominal diameter	Nominal lateral movement absorption	Type LFR 10...	Order No. standard version	Overall length	Weight approx.	Max. width approx.
DN	$2\lambda_{N1}$	–	–	$L_0$	G	B
–	mm	–	–	mm	kg	mm
150	51	.0150.051.0	440090	345	26	385
150	102	.0150.102.0	440091	475	27	385
150	151	.0150.151.0	440092	595	29	385
150	202	.0150.202.0	440093	715	36	385
200	52	.0200.052.0	440094	370	35	468
200	100	.0200.100.0	440095	520	37	468
200	153	.0200.153.0	440096	680	41	468
200	206	.0200.206.0	440097	860	58	468
250	52	.0250.052.0	440098	400	50	555
250	101	.0250.101.0	440099	560	54	555
250	152	.0250.152.0	440100	720	73	555
250	198	.0250.198.0	440101	885	83	555
300	51	.0300.051.0	440102	400	68	629
300	102	.0300.102.0	440103	560	74	629
300	145	.0300.145.0	440104	710	97	629
300	196	.0300.196.0	440105	860	110	629
300	292	.0300.292.0	440106	1160	134	629
350	50	.0350.050.0	440107	415	82	689
350	100	.0350.100.0	440108	585	90	689
350	149	.0350.149.0	440109	770	111	689
350	195	.0350.195.0	440110	920	121	689
350	296	.0350.296.0	440111	1270	146	689

# TYPE LFR 10 ... PN 10

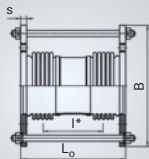
06

Centre-to-centre distance of bellows	Flange <sup>2)</sup>		Spring rate		
	drilling DIN 1092	thickness	$c_1$	$c_2$	$c_3$
I*	PN	s	$c_1$	$c_2$	$c_3$
mm	mm	cm <sup>2</sup>	N/bar	N/mm	N/mm bar
161	16	24	26	74	0
291	16	24	20	24	0
411	16	24	16	12	0
531	16	24	14	7.3	0
199	10	24	53	92	0
349	10	24	40	31	0
509	10	24	31	15	0
668	10	24	25	8	0
207	10	26	107	112	0
367	10	26	81	37	0
527	10	26	65	18	0
676	10	26	54	10	0
199	10	28	188	202	0
359	10	28	142	65	0
488	10	28	115	32	0
638	10	28	96	19	0
938	10	28	73	9.2	0
213	10	28	215	242	0
383	10	28	160	78	0
542	10	28	127	36	0
692	10	28	110	23	0
1042	10	28	81	10	0

2) Available with other hole patterns / thicknesses on request. The overall length L0 may change then.

# LATERAL EXPANSION JOINTS WITH PLAIN FIXED FLANGES, FOR MOVEMENT IN ALL PLANES

Type LFR



06

Nominal diameter	Nominal lateral movement absorption	Type LFR 10...	Order No. standard version	Overall length	Weight approx.	Max. width approx.
DN	$2\lambda_{N1}$	–	–	$L_0$	G	B
–	mm	–	–	mm	kg	mm
400	51	.0400.051.0	440112	510	139	785
400	106	.0400.106.0	440113	750	163	785
400	146	.0400.146.0	440114	900	176	785
400	200	.0400.200.0	440115	1100	193	785
400	287	.0400.287.0	440116	1450	222	785
450	51	.0450.051.0	440117	500	164	756
450	98	.0450.098.0	440118	700	196	756
450	153	.0450.153.0	440119	900	221	756
450	195	.0450.195.0	440120	1050	239	756
450	285	.0450.285.0	440121	1400	284	756
500	51	.0500.051.0	440122	505	187	808
500	105	.0500.105.0	440123	730	223	808
500	148	.0500.148.0	440124	880	243	808
500	207	.0500.207.0	440125	1080	270	808
500	306	.0500.306.0	440126	1480	325	808

# TYPE LFR 10 ... PN 10

06

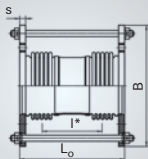
Centre-to-centre distance of bellows	Flange <sup>2)</sup>		Spring rate		
	drilling DIN 1092	thickness	$c_1$	$c_2$	$c_3$
I*	PN	s	$c_1$	$c_2$	$c_3$
mm	mm	cm <sup>2</sup>	N/bar	N/mm	N/mm bar
251	10	37	266	398	0
470	10	37	193	108	0
620	10	37	163	64	0
820	10	37	137	38	0
1170	10	37	108	19	0
246	10	32	307	500	0
425	10	32	225	159	0
625	10	32	181	77	0
775	10	32	159	51	0
1125	10	32	121	25	0
236	10	34	367	581	0
435	10	34	271	163	0
585	10	34	227	94	0
785	10	34	189	54	0
1185	10	34	142	24	0

2) Available with other hole patterns / thicknesses on request. The overall length L0 may change then.



# LATERAL EXPANSION JOINTS WITH PLAIN FIXED FLANGES, FOR MOVEMENT IN ALL PLANES

Type LFR



06

Nominal diameter	Nominal lateral movement absorption	Type LFR 16...	Order No. standard version	Overall length	Weight approx.	Max. width approx.
DN	$2\lambda_{N1}$	–	–	$L_0$	G	B
–	mm	–	–	mm	kg	mm
50	50	.0050.050.0	440127	290	10	265
50	103	.0050.103.0	440128	420	11	265
50	149	.0050.149.0	440129	535	12	265
50	199	.0050.199.0	440130	685	14	265
65	53	.0065.053.0	440131	300	11	285
65	104	.0065.104.0	440132	420	13	285
65	145	.0065.145.0	440133	530	13	285
65	198	.0065.198.0	440134	690	15	285
80	51	.0080.051.0	440135	310	14	300
80	102	.0080.102.0	440136	440	15	300
80	150	.0080.150.0	440137	560	15	300
80	205	.0080.205.0	440138	730	19	300
100	50	.0100.050.0	440139	315	16	320
100	103	.0100.103.0	440140	465	17	320
100	145	.0100.145.0	440141	595	17	320
100	202	.0100.202.0	440142	795	23	320
125	53	.0125.053.0	440143	350	22	350
125	102	.0125.102.0	440144	480	24	350
125	151	.0125.151.0	440145	600	25	350
125	196	.0125.196.0	440146	720	29	350

# TYPE LFR 16 ... PN 16

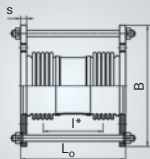
06

Centre-to-centre distance of bellows	Flange <sup>2)</sup>		Spring rate		
	drilling DIN 1092	thickness	$c_1$	$c_2$	$c_3$
I*	PN	s	$c_1$	$c_2$	$c_3$
mm	mm	cm <sup>2</sup>	N/bar	N/mm	N/mm bar
151	16	19	4.4	20	0
281	16	19	3.2	5.8	0
400	16	19	2.5	2.9	0
550	16	19	2	1.5	0
156	16	20	6.4	24	0
276	16	20	4.8	7.7	0
386	16	20	3.9	4	0
546	16	20	3	2	0
161	16	20	8.1	34	0
291	16	20	5.9	11	0
411	16	20	4.8	5.5	0
581	16	20	3.7	2.8	0
173	16	22	12	40	0
323	16	22	8.5	12	0
453	16	22	6.8	6	0
653	16	22	5.2	2.9	0
171	16	22	18	67	0
301	16	22	14	23	0
421	16	22	11	12	0
541	16	22	9.5	7.1	0

2) Available with other hole patterns / thicknesses on request. The overall length L0 may change then.

# LATERAL EXPANSION JOINTS WITH PLAIN FIXED FLANGES, FOR MOVEMENT IN ALL PLANES

Type LFR



06

Nominal diameter	Nominal lateral movement absorption	Type LFR 16...	Order No. standard version	Overall length	Weight approx.	Max. width approx.
DN	$2\lambda_{N1}$	–	–	$L_0$	G	B
–	mm	–	–	mm	kg	mm
150	53	.0150.053.0	440147	365	31	413
150	100	.0150.100.0	440148	495	32	413
150	153	.0150.153.0	440149	635	36	413
150	194	.0150.194.0	440150	765	42	413
200	50	.0200.050.0	440151	370	44	500
200	100	.0200.100.0	440152	530	48	500
200	150	.0200.150.0	440153	680	52	500
200	200	.0200.200.0	440154	870	69	500
250	52	.0250.052.0	440155	460	73	589
250	103	.0250.103.0	440156	680	91	589
250	154	.0250.154.0	440157	880	104	589
250	207	.0250.207.0	440158	1130	121	589
300	50	.0300.050.0	440159	495	110	680
300	95	.0300.095.0	440160	665	125	680
300	145	.0300.145.0	440161	865	143	680
300	196	.0300.196.0	440162	1115	165	680
300	296	.0300.296.0	440163	1615	208	680
350	51	.0350.051.0	440164	515	151	667
350	100	.0350.100.0	440165	715	172	667
350	149	.0350.149.0	440166	915	193	667
350	199	.0350.199.0	440167	1165	220	667
350	306	.0350.306.0	440168	1715	277	667

# TYPE LFR 16 ... PN 16

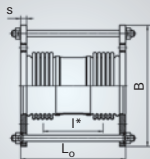
06

Centre-to-centre distance of bellows	Flange <sup>2)</sup>		Spring rate		
	drilling DIN 1092	thickness	$c_1$	$c_2$	$c_3$
$l^*$	PN	s	$c_1$	$c_2$	$c_3$
mm	mm	cm <sup>2</sup>	N/bar	N/mm	N/mm bar
181	16	24	33	85	0
311	16	24	25	30	0
451	16	24	20	14	0
581	16	24	17	8.7	0
193	16	26	75	137	0
353	16	26	55	42	0
503	16	26	45	21	0
672	16	26	36	11	0
246	16	32	117	216	0
445	16	32	87	62	0
645	16	32	69	31	0
895	16	32	55	16	0
235	16	37	176	236	0
405	16	37	136	89	0
605	16	37	109	42	0
855	16	37	88	22	0
1355	16	37	63	8.8	0
260	16	32	182	280	0
460	16	32	138	99	0
660	16	32	111	50	0
910	16	32	88	27	0
1460	16	32	62	11	0

2) Available with other hole patterns / thicknesses on request. The overall length L0 may change then.

# LATERAL EXPANSION JOINTS WITH PLAIN FIXED FLANGES, FOR MOVEMENT IN ALL PLANES

Type LFR



06

Nominal diameter	Nominal lateral movement absorption	Type LFR 10...	Order No. standard version	Overall length	Weight approx.	Max. width approx.
<b>DN</b>	<b><math>2\lambda_{N1}</math></b>	–	–	<b><math>L_0</math></b>	<b>G</b>	<b>B</b>
–	<b>mm</b>	–	–	<b>mm</b>	<b>kg</b>	<b>mm</b>
400	52	.0400.052.0	440169	545	183	723
400	94	.0400.094.0	440170	715	202	723
400	147	.0400.147.0	440171	915	225	723
400	200	.0400.200.0	440172	1115	248	723
400	309	.0400.309.0	440173	1615	306	723
450	50	.0450.050.0	440174	550	243	815
450	104	.0450.104.0	440175	770	274	815
450	155	.0450.155.0	440176	970	301	815
450	203	.0450.203.0	440177	1170	329	815
450	296	.0450.296.0	440178	1620	391	815

# TYPE LFR 16 ... PN 16

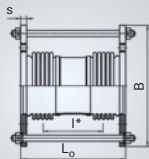
06

Centre-to-centre distance of bellows	Flange <sup>2)</sup>		Spring rate		
	drilling DIN 1092	thickness	$c_r$	$c_s$	$c_p$
I*	PN	s	$c_r$	$c_s$	$c_p$
mm	mm	cm <sup>2</sup>	N/bar	N/mm	N/mm bar
260	16	34	224	407	0
430	16	34	180	166	0
630	16	34	145	81	0
830	16	34	121	48	0
1330	16	34	86	19	0
260	16	37	316	516	0
480	16	37	239	171	0
680	16	37	195	89	0
880	16	37	165	54	0
1330	16	37	122	24	0

2) Available with other hole patterns / thicknesses on request. The overall length L0 may change then.

# LATERAL EXPANSION JOINTS WITH PLAIN FIXED FLANGES, FOR MOVEMENT IN ALL PLANES

Type LFR



06

Nominal diameter	Nominal lateral movement absorption	Type LFR 25...	Order No. standard version	Overall length	Weight approx.	Max. width approx.
DN	$2\lambda_{N1}$	–	–	$L_0$	G	B
–	mm	–	–	mm	kg	mm
50	50	.0050.050.0	440179	300	10	265
50	98	.0050.098.0	440180	430	11	265
50	148	.0050.148.0	440181	600	13	265
50	205	.0050.205.0	440182	800	15	265
65	51	.0065.051.0	440183	320	14	285
65	99	.0065.099.0	440184	470	14	285
65	153	.0065.153.0	440185	670	16	285
65	195	.0065.195.0	440186	830	19	285
80	52	.0080.052.0	440187	335	16	300
80	103	.0080.103.0	440188	475	18	300
80	155	.0080.155.0	440189	645	21	300
80	193	.0080.193.0	440190	785	22	300
100	50	.0100.050.0	440191	345	22	335
100	101	.0100.101.0	440192	515	25	335
100	145	.0100.145.0	440193	675	27	335
100	192	.0100.192.0	440194	860	30	335
125	51	.0125.051.0	440195	365	30	398
125	102	.0125.102.0	440196	525	33	398
125	153	.0125.153.0	440197	715	39	398
125	196	.0125.196.0	440198	900	43	398

# TYPE LFR 25 ... PN 25

06

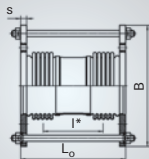
Centre-to-centre distance of bellows	Flange <sup>2)</sup>		Spring rate		
	drilling DIN 1092	thickness	$c_1$	$c_2$	$c_3$
<b>l*</b>	<b>PN</b>	<b>s</b>	<b><math>c_1</math></b>	<b><math>c_2</math></b>	<b><math>c_3</math></b>
<b>mm</b>	<b>mm</b>	<b>cm<sup>2</sup></b>	<b>N/bar</b>	<b>N/mm</b>	<b>N/mm bar</b>
156	40	20	4.3	23	0
286	40	20	3.1	7	0
455	40	20	2.3	2.8	0
655	40	20	1.8	1.4	0
185	40	22	6.1	26	0
335	40	22	4.4	8	0
535	40	22	3.2	3.1	0
695	40	22	2.6	1.9	0
176	40	24	7.8	39	0
316	40	24	5.7	13	0
486	40	24	4.3	5.4	0
626	40	24	3.6	3.3	0
197	40	24	13	54	0
367	40	24	9.6	16	0
527	40	24	7.5	7.8	0
712	40	24	6.1	4.3	0
195	40	26	23	67	0
355	40	26	17	21	0
545	40	26	13	8.8	0
714	40	26	10	4.9	0

2) Available with other hole patterns / thicknesses on request. The overall length L0 may change then.



# LATERAL EXPANSION JOINTS WITH PLAIN FIXED FLANGES, FOR MOVEMENT IN ALL PLANES

Type LFR



06

Nominal diameter	Nominal lateral movement absorption	Type LFR 25...	Order No. standard version	Overall length	Weight approx.	Max. width approx.
DN	$2\lambda_{N1}$	–	–	$L_0$	G	B
–	mm	–	–	mm	kg	mm
150	51	.0150.051.0	440199	370	42	460
150	102	.0150.102.0	440200	540	45	460
150	151	.0150.151.0	440201	740	54	460
150	194	.0150.194.0	440202	945	60	460
200	50	.0200.050.0	440203	440	68	544
200	101	.0200.101.0	440204	640	80	544
200	155	.0200.155.0	440205	910	94	544
200	195	.0200.195.0	440206	1110	104	544
250	51	.0250.051.0	440207	475	125	578
250	101	.0250.101.0	440208	695	147	578
250	149	.0250.149.0	440209	945	167	578
250	204	.0250.204.0	440210	1245	192	578
300	61	.0300.061.0	440211	610	169	634
300	110	.0300.110.0	440212	835	191	634
300	150	.0300.150.0	440213	1035	211	634
300	200	.0300.200.0	440214	1335	240	634
300	302	.0300.302.0	440215	1935	300	634
350	50	.0350.050.0	440216	545	237	735
350	100	.0350.100.0	440217	755	261	735
350	145	.0350.145.0	440218	955	285	735
350	190	.0350.190.0	440219	1205	314	735
350	291	.0350.291.0	440220	1755	378	735

# TYPE LFR 25 ... PN 25

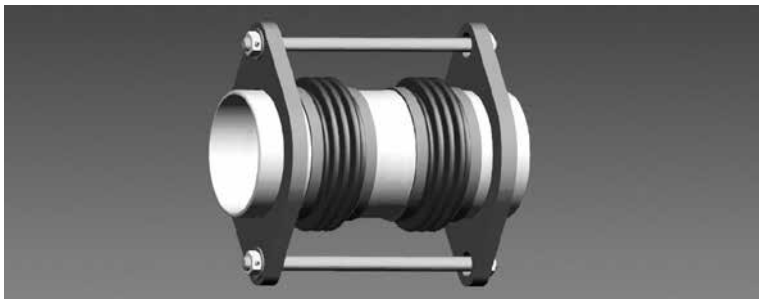
06

Centre-to-centre distance of bellows	Flange <sup>2)</sup>		Spring rate		
	drilling DIN 1092	thickness	$c_1$	$c_2$	$c_3$
$l^*$	PN	s	$c_1$	$c_2$	$c_3$
mm	mm	cm <sup>2</sup>	N/bar	N/mm	N/mm bar
205	40	28	45	85	0
375	40	28	33	26	0
575	40	28	25	11	0
764	40	28	20	6.1	0
241	25	32	79	190	0
441	25	32	59	59	0
690	25	32	44	23	0
890	25	32	36	14	0
251	25	35	117	250	0
450	25	35	85	74	0
700	25	35	64	32	0
1000	25	35	50	16	0
340	25	38	131	213	0
565	25	38	101	83	0
765	25	38	83	46	0
1065	25	38	66	24	0
1665	25	38	46	10	0
260	25	42	194	363	0
470	25	42	150	125	0
670	25	42	122	64	0
920	25	42	99	35	0
1470	25	42	70	14	0

2) Available with other hole patterns / thicknesses on request. The overall length L0 may change then.

# LATERAL EXPANSION JOINTS WITH WELD ENDS TYPE LRR, LRK, LRN

06



## Type designation

The type designation consists of 2 parts

1. Type series, defined by 3 letters
2. Nominal size, defined by 10 digits

## Example

Type LRR: HYDRA lateral expansion joint with weld ends, for movement in all planes

Type LRN: HYDRA lateral expansion joint with weld ends, for movement in one plane

Type LRK: HYDRA lateral expansion joint with weld ends, for movement in all planes

## Standard version/materials:

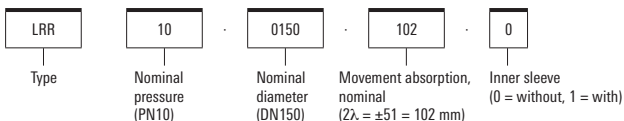
Multi-ply bellow made of 1.4541

Weld ends up to DN 300: P235GH (1.0345)

Weld ends from DN 350: P265GH (1.0425)

Operating temperature: up to 400 °C

## Type designation (example)



## Order text according to guideline 2014/68/EU "Pressure Equipment Directive"

Please state the following with your order:

For standard versions

- Type designation or order number

With material variation

- Type designation
- Details of the materials

According to the Pressure Equipment Directive, the following information is required for testing and documentation:

06

Type of pressure equipment according to Art. 1 & 2:

- Vessel - volume V [l] \_\_\_\_\_
- Piping - nominal diameter DN \_\_\_\_\_

Medium property according to Art. 13:

- Group 1 – dangerous
- Group 2 – all other fluids

State of medium

- Gaseous or liquid if PD > 0.5 bar
- Liquid if PD ≤ 0.5 bar

Design data:

- Max. allowable pressure [bar] \_\_\_\_\_
- Max./min. allowable temperature [°C] \_\_\_\_\_
- Test pressure PT [bar] \_\_\_\_\_

Optional:

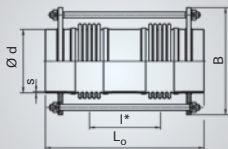
- Category \_\_\_\_\_

### Note

Tell us the dimensions that deviate from the standard and we customize the expansion joint to your specification.

# LATERAL EXPANSION JOINTS WITH WELD ENDS

Type LRR



06

Nominal diameter	Nominal lateral movement absorption	Type LRR 06...	Order No. standard version	Overall length	Weight approx.	Max. width approx.
DN	$2\lambda_{N1}$	–	–	$L_0$	G	B
–	mm	–	–	mm	kg	mm
50	51	.0050.051.0	440579	360	5	205
50	102	.0050.102.0	440580	470	5	205
50	154	.0050.154.0	440581	580	6	205
50	196	.0050.196.0	440582	670	8	205
65	53	.0065.053.0	440583	370	6	225
65	104	.0065.104.0	440584	480	6	225
65	151	.0065.151.0	440585	580	7	225
65	204	.0065.204.0	440586	690	8	225
80	53	.0080.053.0	440587	380	6	240
80	102	.0080.102.0	440588	490	7	240
80	154	.0080.154.0	440589	600	8	240
80	201	.0080.201.0	440590	700	8	240
100	52	.0100.052.0	440591	380	8	265
100	103	.0100.103.0	440592	490	8	265
100	151	.0100.151.0	440593	590	9	265
100	204	.0100.204.0	440594	700	10	265
125	51	.0125.051.0	440595	440	9	290
125	103	.0125.103.0	440596	580	10	290
125	153	.0125.153.0	440597	710	11	290
125	203	.0125.203.0	440598	840	12	290

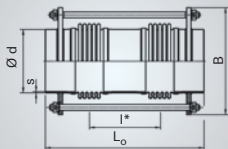
# TYPE LRR 06 ... PN 6

06

Centre-to-centre spacing of bellows	Weld end		Spring rate		
	outside diameter	wall thickness			
I*	d	s	c <sub>r</sub>	c <sub>s</sub>	c <sub>p</sub>
mm	mm	mm	N/bar	N/mm	N/mm bar
136	60.3	2,9	4.2	13	0
246	60.3	2,9	3.2	4.1	0
356	60.3	2,9	2.6	2	0
445	60.3	2,9	2.2	1.3	0
141	76.1	2,9	6.2	16	0
251	76.1	2,9	4.7	5.2	0
351	76.1	2,9	3.9	2.7	0
461	76.1	2,9	3.3	1.5	0
146	88.9	3,2	7.7	19	0
256	88.9	3,2	5.9	6.5	0
366	88.9	3,2	4.8	3.2	0
466	88.9	3,2	4.1	2	0
141	114.3	3,6	12	27	0
251	114.3	3,6	9.2	8.8	0
351	114.3	3,6	7.6	4.5	0
461	114.3	3,6	6.4	2.6	0
183	139.7	4	14	30	0
323	139.7	4	11	9	0
453	139.7	4	8.7	4.5	0
583	139.7	4	7.3	2.7	0

# LATERAL EXPANSION JOINTS WITH WELD ENDS

Type LRR



06

Nominal diameter	Nominal lateral movement absorption	Type LRR 06...	Order No. standard version	Overall length	Weight approx.	Max. width approx.
DN	$2\lambda_{N1}$	–	–	$L_0$	G	B
–	mm	–	–	mm	kg	mm
150	53	.0150.053.0	440599	455	15	320
150	101	.0150.101.0	440600	575	16	320
150	151	.0150.151.0	440601	695	17	320
150	202	.0150.202.0	440602	815	19	320
200	51	.0200.051.0	440603	490	23	375
200	100	.0200.100.0	440604	620	25	375
200	153	.0200.153.0	440605	750	27	375
200	198	.0200.198.0	440606	880	40	375
250	50	.0250.050.0	440607	520	37	465
250	102	.0250.102.0	440608	660	40	465
250	153	.0250.153.0	440609	790	42	465
250	212	.0250.212.0	440610	960	64	465
300	50	.0300.050.0	440611	555	49	550
300	101	.0300.101.0	440612	715	53	550
300	152	.0300.152.0	440613	865	57	550
300	196	.0300.196.0	440614	1020	89	550
300	296	.0300.296.0	440615	1320	112	550
350	52	.0350.052.0	440616	585	52	590
350	102	.0350.102.0	440617	755	56	590
350	148	.0350.148.0	440618	925	78	590
350	195	.0350.195.0	440619	1075	88	590
350	300	.0350.300.0	440620	1425	111	590

# TYPE LRR 06 ... PN 6

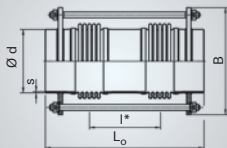
06

Centre-to-centre spacing of bellows	Weld end		Spring rate		
	outside diameter	wall thickness	$c_1$	$c_2$	$c_3$
$l^*$	$d$	$s$	$c_1$	$c_2$	$c_3$
mm	mm	mm	N/bar	N/mm	N/mm bar
182	168.3	4	19	58	0
302	168.3	4	15	20	0
422	168.3	4	12	10	0
542	168.3	4	11	6.1	0
186	219.1	4,5	37	89	0
316	219.1	4,5	29	30	0
446	219.1	4,5	24	14	0
535	219.1	4,5	20	8.6	0
191	273	5	72	111	0
331	273	5	57	36	0
461	273	5	47	18	0
590	273	5	38	9.5	0
215	323.9	5,6	137	140	0
375	323.9	5,6	105	43	0
525	323.9	5,6	87	21	0
630	323.9	5,6	73	13	0
930	323.9	5,6	56	5.9	0
239	355.6	8	157	153	0
409	355.6	8	120	49	0
534	355.6	8	96	24	0
684	355.6	8	82	15	0
1034	355.6	8	62	6.6	0



# LATERAL EXPANSION JOINTS WITH WELD ENDS

Type LRR



06

Nominal diameter	Nominal lateral movement absorption	Type LRR 06...	Order No. standard version	Overall length	Weight approx.	Max. width approx.
DN	$2\lambda_{N1}$	–	–	$L_0$	G	B
–	mm	–	–	mm	kg	mm
400	51	.0400.051.0	440621	645	75	665
400	100	.0400.100.0	440622	850	95	665
400	158	.0400.158.0	440623	1050	111	665
400	200	.0400.200.0	440624	1200	123	665
400	294	.0400.294.0	440625	1600	154	665
450	50	.0450.050.0	440626	655	84	725
450	97	.0450.097.0	440627	860	106	725
450	152	.0450.152.0	440628	1060	123	725
450	192	.0450.192.0	440629	1210	136	725
450	289	.0450.289.0	440630	1570	171	725
500	52	.0500.052.0	440631	750	128	820
500	104	.0500.104.0	440632	965	153	820
500	147	.0500.147.0	440633	1115	168	820
500	207	.0500.207.0	440634	1315	188	820
500	289	.0500.289.0	440635	1615	218	820

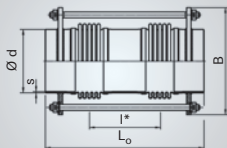
# TYPE LRR 06 ... PN 6

06

Centre-to-centre spacing of bellows	Weld end		Spring rate		
	outside diameter	wall thickness			
I*	d	s	c <sub>1</sub>	c <sub>2</sub>	c <sub>3</sub>
mm	mm	mm	N/bar	N/mm	N/mm bar
255	406.4	8,8	235	232	0
410	406.4	8,8	178	69	0
610	406.4	8,8	143	33	0
760	406.4	8,8	123	21	0
1210	406.4	8,8	92	9.5	0
260	457	8	286	282	0
415	457	8	218	86	0
615	457	8	176	41	0
765	457	8	155	27	0
1120	457	8	119	17	0
264	508	8	375	389	0
425	508	8	286	113	0
575	508	8	248	64	0
775	508	8	209	36	0
1075	508	8	168	19	0

# LATERAL EXPANSION JOINTS WITH WELD ENDS

Type LRR



06

Nominal diameter	Nominal lateral movement absorption	Type LRR 10...	Order No. standard version	Overall length	Weight approx.	Max. width approx.
DN	$2\lambda_{N1}$	—	—	$L_o$	G	B
—	mm	—	—	mm	kg	mm
50	51	.0050.051.0	440636	360	5	205
50	102	.0050.102.0	440637	470	5	205
50	149	.0050.149.0	440638	580	6	205
50	202	.0050.202.0	440639	720	9	205
65	53	.0065.053.0	440640	370	6	225
65	104	.0065.104.0	440641	480	6	225
65	146	.0065.146.0	440642	580	7	225
65	201	.0065.201.0	440643	730	8	225
80	53	.0080.053.0	440644	420	7	240
80	101	.0080.101.0	440645	540	8	240
80	151	.0080.151.0	440646	660	9	240
80	202	.0080.202.0	440647	780	10	240
100	50	.0100.050.0	440648	410	9	265
100	100	.0100.100.0	440649	540	10	265
100	146	.0100.146.0	440650	670	11	265
100	203	.0100.203.0	440651	850	12	265
125	50	.0125.050.0	440652	435	12	290
125	100	.0125.100.0	440653	555	13	290
125	153	.0125.153.0	440654	675	14	290
125	200	.0125.200.0	440655	785	15	290

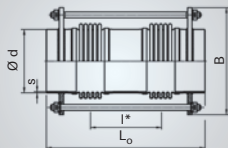
# TYPE LRR 10 ... PN 10

06

Centre-to-centre spacing of bellows	Weld end		Spring rate		
	outside diameter	wall thickness			
I*	d	s	c <sub>r</sub>	c <sub>s</sub>	c <sub>p</sub>
mm	mm	mm	N/bar	N/mm	N/mm bar
136	60.3	2,9	4.2	13	0
246	60.3	2,9	3.2	4.1	0
356	60.3	2,9	2.6	2	0
495	60.3	2,9	2.1	1	0
141	76.1	2,9	6.2	16	0
251	76.1	2,9	4.7	5.2	0
351	76.1	2,9	3.9	2.7	0
501	76.1	2,9	3.1	1.3	0
161	88.9	3,2	7.4	29	0
281	88.9	3,2	5.6	9.7	0
401	88.9	3,2	4.6	4.8	0
521	88.9	3,2	3.8	2.9	0
159	114.3	3,6	11	27	0
289	114.3	3,6	8.5	8.3	0
419	114.3	3,6	6.8	4	0
599	114.3	3,6	5.3	1.9	0
167	139.7	4	14	50	0
287	139.7	4	11	16	0
407	139.7	4	9	7.9	0
517	139.7	4	7.7	4.8	0

# LATERAL EXPANSION JOINTS WITH WELD ENDS

Type LRR



06

Nominal diameter	Nominal lateral movement absorption	Type LRR 10...	Order No. standard version	Overall length	Weight approx.	Max. width approx.
DN	$2\lambda_{N1}$	—	—	$L_0$	G	B
—	mm	—	—	mm	kg	mm
150	51	.0150.051.0	440656	475	17	320
150	102	.0150.102.0	440657	605	19	320
150	151	.0150.151.0	440658	725	20	320
150	202	.0150.202.0	440659	845	22	320
200	52	.0200.052.0	440660	530	29	405
200	100	.0200.100.0	440661	680	32	405
200	153	.0200.153.0	440662	840	35	405
200	206	.0200.206.0	440663	1015	52	405
250	52	.0250.052.0	440664	565	47	495
250	101	.0250.101.0	440665	725	51	495
250	152	.0250.152.0	440666	885	55	495
250	198	.0250.198.0	440667	1055	80	495
300	51	.0300.051.0	440668	590	73	575
300	102	.0300.102.0	440669	750	79	575
300	145	.0300.145.0	440670	905	102	575
300	196	.0300.196.0	440671	1055	114	575
300	292	.0300.292.0	440672	1355	139	575
350	50	.0350.050.0	440673	650	71	610
350	100	.0350.100.0	440674	820	78	610
350	149	.0350.149.0	440675	1005	99	610
350	195	.0350.195.0	440676	1155	109	610
350	296	.0350.296.0	440677	1505	134	610

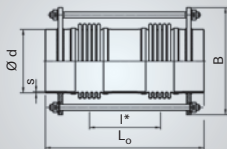
# TYPE LRR 10 ... PN 10

06

Centre-to-centre spacing of bellows	Weld end		Spring rate		
	outside diameter	wall thickness			
I*	d	s	c <sub>1</sub>	c <sub>2</sub>	c <sub>3</sub>
mm	mm	mm	N/bar	N/mm	N/mm bar
177	168.3	4	23	74	0
307	168.3	4	18	24	0
427	168.3	4	15	12	0
547	168.3	4	13	7.3	0
219	219.1	4.5	47	92	0
369	219.1	4.5	36	31	0
529	219.1	4.5	29	15	0
668	219.1	4.5	24	8	0
227	273	5	97	112	0
387	273	5	75	37	0
547	273	5	61	18	0
676	273	5	51	10	0
223	323.9	5.6	162	202	0
383	323.9	5.6	127	65	0
488	323.9	5.6	104	32	0
638	323.9	5.6	90	19	0
938	323.9	5.6	70	9.2	0
237	355.6	8	193	242	0
407	355.6	8	147	78	0
542	355.6	8	119	36	0
692	355.6	8	102	23	0
1042	355.6	8	78	10	0

# LATERAL EXPANSION JOINTS WITH WELD ENDS

Type LRR



06

Nominal diameter	Nominal lateral movement absorption	Type LRR 10...	Order No. standard version	Overall length	Weight approx.	Max. width approx.
DN	$2\lambda_{N1}$	–	–	$L_0$	G	B
–	mm	–	–	mm	kg	mm
400	51	.0400.051.0	440678	715	114	700
400	106	.0400.106.0	440679	960	136	700
400	146	.0400.146.0	440680	1110	149	700
400	200	.0400.200.0	440681	1310	166	700
400	287	.0400.287.0	440682	1660	196	700
450	51	.0450.051.0	440683	715	141	690
450	98	.0450.098.0	440684	920	171	690
450	153	.0450.153.0	440685	1120	196	690
450	195	.0450.195.0	440686	1270	215	690
450	285	.0450.285.0	440687	1620	259	690
500	51	.0500.051.0	440688	720	158	740
500	105	.0500.105.0	440689	945	193	740
500	148	.0500.148.0	440690	1095	213	740
500	207	.0500.207.0	440691	1295	240	740
500	306	.0500.306.0	440692	1695	295	740

# TYPE LRR 10 ... PN 10

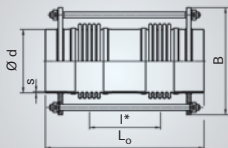
06

Centre-to-centre spacing of bellows	Weld end		Spring rate		
	outside diameter	wall thickness			
<b>l*</b>	<b>d</b>	<b>s</b>	<b>c<sub>r</sub></b>	<b>c<sub>s</sub></b>	<b>c<sub>p</sub></b>
<b>mm</b>	<b>mm</b>	<b>mm</b>	<b>N/bar</b>	<b>N/mm</b>	<b>N/mm bar</b>
275	406.4	8.8	250	398	0
470	406.4	8.8	185	108	0
620	406.4	8.8	157	64	0
820	406.4	8.8	133	38	0
1170	406.4	8.8	105	19	0
270	457	8	279	500	0
425	457	8	214	159	0
625	457	8	174	77	0
775	457	8	151	51	0
1125	457	8	118	25	0
264	508	10	334	581	0
435	508	10	247	163	0
585	508	10	214	94	0
785	508	10	180	54	0
1185	508	10	137	24	0



# LATERAL EXPANSION JOINTS WITH WELD ENDS

Type LRR



06

Nominal diameter	Nominal lateral movement absorption	Type LRR 16...	Order No. standard version	Overall length	Weight approx.	Max. width approx.
DN	$2\lambda_{N1}$	–	–	$L_o$	G	B
–	mm	–	–	mm	kg	mm
50	50	.0050.050.0	440693	380	5	205
50	103	.0050.103.0	440694	510	6	205
50	149	.0050.149.0	440695	630	7	205
50	199	.0050.199.0	440696	780	9	205
65	53	.0065.053.0	440697	410	8	225
65	104	.0065.104.0	440698	530	8	225
65	145	.0065.145.0	440699	640	9	225
65	198	.0065.198.0	440700	800	10	225
80	51	.0080.051.0	440701	420	9	240
80	102	.0080.102.0	440702	550	10	240
80	150	.0080.150.0	440703	670	11	240
80	205	.0080.205.0	440704	840	12	240
100	50	.0100.050.0	440705	425	10	265
100	103	.0100.103.0	440706	575	12	265
100	145	.0100.145.0	440707	705	13	265
100	202	.0100.202.0	440708	905	18	265
125	53	.0125.053.0	440709	485	17	290
125	102	.0125.102.0	440710	615	19	290
125	151	.0125.151.0	440711	735	21	290
125	196	.0125.196.0	440712	855	23	290

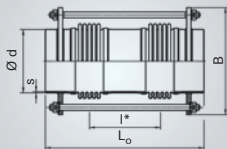
# TYPE LRR 16 ... PN 16

06

Centre-to-centre spacing of bellows	Weld end		Spring rate		
	outside diameter	wall thickness			
I*	d	s	c <sub>1</sub>	c <sub>2</sub>	c <sub>3</sub>
mm	mm	mm	N/bar	N/mm	N/mm bar
151	60.3	2.9	4	20	0
281	60.3	2.9	3	5.8	0
401	60.3	2.9	2.4	2.9	0
550	60.3	2.9	1.9	1.5	0
156	76.1	2.9	5.8	24	0
276	76.1	2.9	4.4	7.7	0
386	76.1	2.9	3.6	4	0
546	76.1	2.9	2.9	2	0
161	88.9	3.2	7.3	34	0
291	88.9	3.2	5.5	11	0
411	88.9	3.2	4.5	5.5	0
581	88.9	3.2	3.5	2.8	0
173	114.3	3.6	11	40	0
323	114.3	3.6	7.9	12	0
453	114.3	3.6	6.4	6	0
653	114.3	3.6	5	2.9	0
187	139.7	4	16	67	0
317	139.7	4	12	23	0
437	139.7	4	10	12	0
557	139.7	4	8.8	7.1	0

# LATERAL EXPANSION JOINTS WITH WELD ENDS

Type LRR



06

Nominal diameter	Nominal lateral movement absorption	Type LRR 16...	Order No. standard version	Overall length	Weight approx.	Max. width approx.
DN	$2\lambda_{N1}$	—	—	$L_0$	G	B
—	mm	—	—	mm	kg	mm
150	53	.0150.053.0	440713	515	24	350
150	100	.0150.100.0	440714	645	26	350
150	153	.0150.153.0	440715	785	29	350
150	194	.0150.194.0	440716	915	35	350
200	50	.0200.050.0	440717	545	40	435
200	100	.0200.100.0	440718	705	44	435
200	150	.0200.150.0	440719	855	48	435
200	200	.0200.200.0	440720	1045	65	435
250	52	.0250.052.0	440721	640	65	520
250	103	.0250.103.0	440722	860	83	520
250	154	.0250.154.0	440723	1060	96	520
250	207	.0250.207.0	440724	1310	112	520
300	50	.0300.050.0	440725	710	107	610
300	95	.0300.095.0	440726	880	122	610
300	145	.0300.145.0	440727	1080	140	610
300	196	.0300.196.0	440728	1330	162	610
300	296	.0300.296.0	440729	1830	206	610
350	51	.0350.051.0	440730	740	116	580
350	100	.0350.100.0	440731	940	137	580
350	149	.0350.149.0	440732	1140	158	580
350	199	.0350.199.0	440733	1390	184	580
350	306	.0350.306.0	440734	1940	242	580

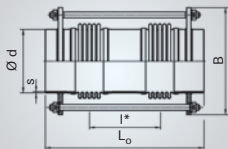
# TYPE LRR 16 ... PN 16

06

Centre-to-centre spacing of bellows	Weld end		Spring rate		
	outside diameter	wall thickness	$c_1$	$c_2$	$c_3$
$l^*$	$d$	$s$	$c_1$	$c_2$	$c_3$
mm	mm	mm	N/bar	N/mm	N/mm bar
197	168.3	4	29	85	0
327	168.3	4	23	30	0
467	168.3	4	19	14	0
597	168.3	4	16	8.7	0
213	219.1	4.5	65	137	0
373	219.1	4.5	50	42	0
523	219.1	4.5	41	21	0
672	219.1	4.5	34	11	0
266	273	5	106	216	0
445	273	5	79	62	0
645	273	5	64	31	0
895	273	5	52	16	0
235	323.9	5.6	156	236	0
405	323.9	5.6	127	89	0
605	323.9	5.6	103	42	0
855	323.9	5.6	83	22	0
1355	323.9	5.6	60	8.8	0
260	355.6	8	166	280	0
460	355.6	8	129	99	0
660	355.6	8	105	50	0
910	355.6	8	84	27	0
1460	355.6	8	60	11	0

# LATERAL EXPANSION JOINTS WITH WELD ENDS

Type LRR



06

Nominal diameter	Nominal lateral movement absorption	Type LRR 16...	Order No. standard version	Overall length	Weight approx.	Max. width approx.
DN	$2\lambda_{N1}$	–	–	$L_0$	G	B
–	mm	–	–	mm	kg	mm
400	52	.0400.052.0	440735	760	141	630
400	94	.0400.094.0	440736	930	160	630
400	147	.0400.147.0	440737	1130	183	630
400	200	.0400.200.0	440738	1330	207	630
400	309	.0400.309.0	440739	1830	264	630
450	50	.0450.050.0	440740	800	198	720
450	104	.0450.104.0	440741	1020	228	720
450	155	.0450.155.0	440742	1220	255	720
450	203	.0450.203.0	440743	1420	283	720
450	296	.0450.296.0	440744	1870	346	720

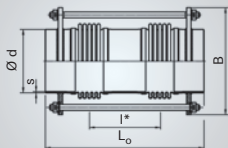
# TYPE LRR 16 ... PN 16

06

Centre-to-centre spacing of bellows	Weld end		Spring rate		
	outside diameter	wall thickness			
<b>l*</b>	<b>d</b>	<b>s</b>	<b>c<sub>1</sub></b>	<b>c<sub>2</sub></b>	<b>c<sub>3</sub></b>
<b>mm</b>	<b>mm</b>	<b>mm</b>	<b>N/bar</b>	<b>N/mm</b>	<b>N/mm bar</b>
260	406.4	8.8	211	407	0
430	406.4	8.8	168	166	0
630	406.4	8.8	137	81	0
830	406.4	8.8	115	48	0
1330	406.4	8.8	83	19	0
260	457	8	290	516	0
480	457	8	224	171	0
680	457	8	185	89	0
880	457	8	158	54	0
1330	457	8	118	24	0

# LATERAL EXPANSION JOINTS WITH WELD ENDS

Type LRR



06

Nominal diameter	Nominal lateral movement absorption	Type LRR 25...	Order No. standard version	Overall length	Weight approx.	Max. width approx.
DN	$2\lambda_{N1}$	–	–	$L_0$	G	B
–	mm	–	–	mm	kg	mm
50	50	.0050.050.0	440745	410	7	205
50	98	.0050.098.0	440746	540	8	205
50	148	.0050.148.0	440747	710	10	205
50	205	.0050.205.0	440748	910	12	205
65	51	.0065.051.0	440749	430	8	225
65	99	.0065.099.0	440750	580	9	225
65	153	.0065.153.0	440751	780	11	225
65	195	.0065.195.0	440752	940	14	225
80	52	.0080.052.0	440753	440	11	240
80	103	.0080.103.0	440754	580	13	240
80	155	.0080.155.0	440755	750	15	240
80	193	.0080.193.0	440756	890	17	240
100	50	.0100.050.0	440757	475	14	265
100	101	.0100.101.0	440758	645	18	265
100	145	.0100.145.0	440759	805	20	265
100	192	.0100.192.0	440760	990	24	265
125	51	.0125.051.0	440761	515	22	320
125	102	.0125.102.0	440762	675	24	320
125	153	.0125.153.0	440763	865	27	320
125	196	.0125.196.0	440764	1050	33	320

# TYPE LRR 25 ... PN 25

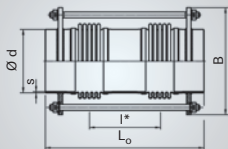
06

Centre-to-centre spacing of bellows	Weld end		Spring rate		
	outside diameter	wall thickness	$c_1$	$c_2$	$c_3$
$l^*$	$d$	$s$	$c_1$	$c_2$	$c_3$
mm	mm	mm	N/bar	N/mm	N/mm bar
156	60.3	2.9	3.9	23	0
286	60.3	2.9	2.9	7	0
455	60.3	2.9	2.2	2.8	0
655	60.3	2.9	1.7	1.4	0
185	76.1	2.9	5.5	26	0
335	76.1	2.9	4.1	8	0
535	76.1	2.9	3	3.1	0
695	76.1	2.9	2.5	1.9	0
176	88.9	3.2	6.9	39	0
316	88.9	3.2	5.2	13	0
486	88.9	3.2	4	5.4	0
626	88.9	3.2	3.4	3.3	0
197	114.3	3.6	12	54	0
367	114.3	3.6	9	16	0
527	114.3	3.6	7.1	7.8	0
712	114.3	3.6	5.8	4.3	0
211	139.7	4	20	67	0
371	139.7	4	15	21	0
561	139.7	4	12	8.8	0
714	139.7	4	9.7	4.9	0



# LATERAL EXPANSION JOINTS WITH WELD ENDS

Type LRR



06

Nominal diameter	Nominal lateral movement absorption	Type LRR 25...	Order No. standard version	Overall length	Weight approx.	Max. width approx.
DN	$2\lambda_{N1}$	–	–	$L_0$	G	B
–	mm	–	–	mm	kg	mm
150	51	.0150.051.0	440765	545	30	380
150	102	.0150.102.0	440766	715	34	380
150	151	.0150.151.0	440767	915	39	380
150	194	.0150.194.0	440768	1120	49	380
200	50	.0200.050.0	440769	670	64	460
200	101	.0200.101.0	440770	870	76	460
200	155	.0200.155.0	440771	1140	90	460
200	195	.0200.195.0	440772	1340	100	460
250	51	.0250.051.0	440773	650	92	495
250	101	.0250.101.0	440774	910	112	495
250	149	.0250.149.0	440775	1160	133	495
250	204	.0250.204.0	440776	1460	158	495
300	61	.0300.061.0	440777	825	144	545
300	110	.0300.110.0	440778	1050	166	545
300	150	.0300.150.0	440779	1250	186	545
300	200	.0300.200.0	440780	1550	216	545
300	302	.0300.302.0	440781	2150	274	545
350	50	.0350.050.0	440782	790	154	615
350	100	.0350.100.0	440783	1000	178	615
350	145	.0350.145.0	440784	1200	201	615
350	190	.0350.190.0	440785	1450	231	615
350	291	.0350.291.0	440786	2000	295	615

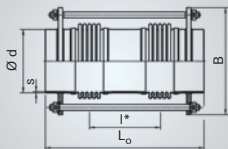
# TYPE LRR 25 ... PN 25

06

Centre-to-centre spacing of bellows	Weld end		Spring rate		
	outside diameter	wall thickness	$c_1$	$c_2$	$c_3$
$l^*$	$d$	$s$	$c_1$	$c_2$	$c_3$
mm	mm	mm	N/bar	N/mm	N/mm bar
221	168.3	4	39	85	0
391	168.3	4	30	26	0
591	168.3	4	23	11	0
764	168.3	4	19	6.1	0
261	219.1	4.5	70	190	0
461	219.1	4.5	53	59	0
690	219.1	4.5	40	23	0
890	219.1	4.5	34	14	0
271	273	5	106	250	0
450	273	5	79	74	0
700	273	5	61	32	0
1000	273	5	48	16	0
340	323.9	5.6	118	213	0
565	323.9	5.6	93	83	0
765	323.9	5.6	78	46	0
1065	323.9	5.6	62	24	0
1665	323.9	5.6	45	10	0
260	355.6	8	179	363	0
470	355.6	8	141	125	0
670	355.6	8	116	64	0
920	355.6	8	94	35	0
1470	355.6	8	68	14	0

# LATERAL EXPANSION JOINTS WITH WELD ENDS

Type LRR



06

Nominal diameter	Nominal lateral movement absorption	Type LRR 40...	Order No. standard version	Overall length	Weight approx.	Max. width approx.
DN	$2\lambda_{N1}$	—	—	$L_0$	G	B
—	mm	—	—	mm	kg	mm
50	53	.0050.053.0	440787	440	7	205
50	100	.0050.100.0	440788	640	9	205
50	146	.0050.146.0	440789	840	11	205
50	204	.0050.204.0	440790	1090	13	205
65	49	.0065.049.0	440791	465	11	225
65	100	.0065.100.0	440792	665	14	225
65	156	.0065.156.0	440793	915	17	225
65	200	.0065.200.0	440794	1115	20	225
80	51	.0080.051.0	440795	475	13	240
80	101	.0080.101.0	440796	675	15	240
80	156	.0080.156.0	440797	925	18	240
80	188	.0080.188.0	440798	1075	22	240
100	46	.0100.046.0	440799	590	25	325
100	96	.0100.096.0	440800	830	32	325
100	146	.0100.146.0	440801	1130	39	325
100	197	.0100.197.0	440802	1430	46	325
125	46	.0125.046.0	440803	600	31	350
125	94	.0125.094.0	440804	850	37	350
125	152	.0125.152.0	440805	1200	46	350
125	193	.0125.193.0	440806	1450	53	350

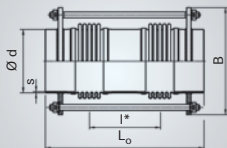
# TYPE LRR 40 ... PN 40

06

Centre-to-centre spacing of bellows	Weld end		Spring rate		
	outside diameter	wall thickness			
I*	d	s	c <sub>1</sub>	c <sub>2</sub>	c <sub>3</sub>
mm	mm	mm	N/bar	N/mm	N/mm bar
194	60.3	2.9	3.5	19	0
394	60.3	2.9	2.4	4.7	0
594	60.3	2.9	1.8	2.1	0
844	60.3	2.9	1.4	1	0
198	76.1	2.9	6.2	33	0
398	76.1	2.9	4.3	8.4	0
648	76.1	2.9	3.1	3.2	0
848	76.1	2.9	2.6	1.8	0
202	88.9	3.2	8	38	0
402	88.9	3.2	5.6	9.8	0
652	88.9	3.2	4.1	3.7	0
802	88.9	3.2	3.5	2.5	0
265	114.3	3.6	19	63	0
465	114.3	3.6	13	20	0
765	114.3	3.6	9.6	7.8	0
1065	114.3	3.6	7.6	4.1	0
230	139.7	4	25	78	0
480	139.7	4	17	20	0
830	139.7	4	12	6.8	0
1080	139.7	4	10	4.1	0

# LATERAL EXPANSION JOINTS WITH WELD ENDS

Type LRR



06

Nominal diameter	Nominal lateral movement absorption	Type LRR 40...	Order No. standard version	Overall length	Weight approx.	Max. width approx.
DN	$2\lambda_{N1}$	–	–	$L_o$	G	B
–	mm	–	–	mm	kg	mm
150	55	.0150.055.0	440807	730	51	405
150	96	.0150.096.0	440808	980	60	405
150	149	.0150.149.0	440809	1330	73	405
150	195	.0150.195.0	440810	1630	83	405
200	54	.0200.054.0	440811	760	99	440
200	97	.0200.097.0	440812	960	113	440
200	149	.0200.149.0	440813	1260	133	440
200	206	.0200.206.0	440814	1610	156	440
250	45	.0250.045.0	440815	720	136	530
250	97	.0250.097.0	440816	970	159	530
250	151	.0250.151.0	440817	1320	193	530
250	206	.0250.206.0	440818	1670	225	530

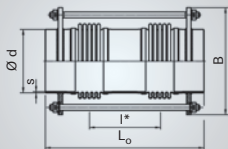
# TYPE LRR 40 ... PN 40

06

Centre-to-centre spacing of bellows	Weld end		Spring rate		
	outside diameter	wall thickness			
<b>l*</b>	<b>d</b>	<b>s</b>	<b>c<sub>r</sub></b>	<b>c<sub>s</sub></b>	<b>c<sub>p</sub></b>
<b>mm</b>	<b>mm</b>	<b>mm</b>	<b>N/bar</b>	<b>N/mm</b>	<b>N/mm bar</b>
314	168.3	4	38	74	0
564	168.3	4	28	24	0
914	168.3	4	21	9.4	0
1214	168.3	4	17	5.4	0
300	219.1	4.5	60	161	0
500	219.1	4.5	48	62	0
800	219.1	4.5	36	25	0
1150	219.1	4.5	28	12	0
255	273	6.3	110	288	0
505	273	6.3	83	82	0
855	273	6.3	60	30	0
1205	273	6.3	48	15	0

# LATERAL EXPANSION JOINTS WITH WELD ENDS

Type LRR



06

Nominal diameter	Nominal lateral movement absorption	Type LRR 63...	Order No. standard version	Overall length	Weight approx.	Max. width approx.
DN	$2\lambda_{N1}$	—	—	$L_0$	G	B
—	mm	—	—	mm	kg	mm
50	50	.0050.050.0	440819	555	10	205
50	96	.0050.096.0	440820	790	13	205
50	155	.0050.155.0	440821	1140	17	205
50	198	.0050.198.0	440822	1390	20	205
65	55	.0065.055.0	440823	570	16	255
65	96	.0065.096.0	440824	820	20	255
65	145	.0065.145.0	440825	1120	25	255
65	203	.0065.203.0	440826	1470	30	255
80	50	.0080.050.0	440827	590	25	300
80	98	.0080.098.0	440828	890	31	300
80	152	.0080.152.0	440829	1240	38	300
80	198	.0080.198.0	440830	1540	44	300
100	50	.0100.050.0	440831	700	43	350
100	98	.0100.098.0	440832	1000	52	350
100	155	.0100.155.0	440833	1400	65	350
100	197	.0100.197.0	440834	1700	74	350
125	55	.0125.055.0	440835	740	60	410
125	99	.0125.099.0	440836	1040	73	410
125	143	.0125.143.0	440837	1340	87	410
125	201	.0125.201.0	440838	1740	104	410

# TYPE LRR 63 ... PN 63

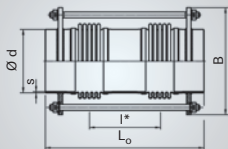
06

Centre-to-centre spacing of bellows	Weld end		Spring rate		
	outside diameter	wall thickness			
<b>l*</b>	<b>d</b>	<b>s</b>	<b>c<sub>1</sub></b>	<b>c<sub>2</sub></b>	<b>c<sub>3</sub></b>
<b>mm</b>	<b>mm</b>	<b>mm</b>	<b>N/bar</b>	<b>N/mm</b>	<b>N/mm bar</b>
260	60.3	2.9	3.6	28	0
510	60.3	2.9	2.5	7.3	0
860	60.3	2.9	1.7	2.6	0
1110	60.3	2.9	1.4	1.5	0
265	76.1	3.2	6.9	35	0
515	76.1	3.2	4.8	9.3	0
815	76.1	3.2	3.5	3.7	0
1165	76.1	3.2	2.6	1.8	0
265	88.9	4	12	44	0
565	88.9	4	8.1	9.8	0
915	88.9	4	5.8	3.8	0
1165	88.9	4	4.8	2.3	0
290	114.3	4.5	20	68	0
590	114.3	4.5	14	17	0
990	114.3	4.5	10	6	0
1290	114.3	4.5	8.2	3.6	0
318	139.7	6.3	30	67	0
618	139.7	6.3	21	19	0
918	139.7	6.3	17	8.7	0
1318	139.7	6.3	13	4.2	0



# LATERAL EXPANSION JOINTS WITH WELD ENDS

Type LRR



06

Nominal diameter	Nominal lateral movement absorption	Type LRR 63...	Order No. standard version	Overall length	Weight approx.	Max. width approx.
<b>DN</b>	<b><math>2\lambda_{N1}</math></b>	–	–	<b><math>L_0</math></b>	<b>G</b>	<b>B</b>
–	<b>mm</b>	–	–	<b>mm</b>	<b>kg</b>	<b>mm</b>
150	50	.0150.050.0	440839	750	83	385
150	98	.0150.098.0	440840	1050	101	385
150	153	.0150.153.0	440841	1450	124	385
150	195	.0150.195.0	440842	1750	142	385
200	53	.0200.053.0	440843	910	147	475
200	95	.0200.095.0	440844	1210	174	475
200	142	.0200.142.0	440845	1610	209	475
200	199	.0200.199.0	440846	2110	253	475

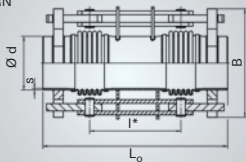
# TYPE LRR 63 ... PN 63

06

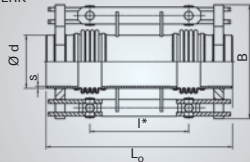
Centre-to-centre spacing of bellows	Weld end		Spring rate		
	outside diameter	wall thickness			
<b>l*</b>	<b>d</b>	<b>s</b>	<b>c<sub>r</sub></b>	<b>c<sub>s</sub></b>	<b>c<sub>p</sub></b>
<b>mm</b>	<b>mm</b>	<b>mm</b>	<b>N/bar</b>	<b>N/mm</b>	<b>N/mm bar</b>
295	168.3	5.6	38	116	0
595	168.3	5.6	27	31	0
995	168.3	5.6	19	11	0
1295	168.3	5.6	16	6.9	0
405	219.1	8	59	188	0
705	219.1	8	44	65	0
1105	219.1	8	33	27	0
1605	219.1	8	25	13	0

# LATERAL EXPANSION JOINT WITH WELD ENDS

Type LRN



Type LRK



06

Nominal diameter	Nominal lateral movement absorption	Type LRN 06 ... LRK 06 ...	Order No. standard version		LRN		LRK		Max. width approx.
			LRN	LRK	overall length	weight approx.	overall length	weight approx.	
DN	$2\lambda_{N1}$	—	—	—	$L_0$	G	$L_0$	G	B
—	mm	—	—	—	mm	kg	mm	kg	mm
600	58	.0600.058.0	440395	440221	795	206	795	235	900
600	108	.0600.108.0	440396	440222	905	222	905	252	900
600	150	.0600.150.0	440397	440223	1055	243	1055	273	900
600	205	.0600.205.0	440398	440224	1255	272	1255	301	900
600	302	.0600.302.0	440399	440225	1605	322	1605	351	900
700	53	.0700.053.0	440400	440226	835	285	835	314	1010
700	98	.0700.098.0	440401	440227	945	303	945	332	1010
700	152	.0700.152.0	440402	440228	1100	332	1100	362	1010
700	211	.0700.211.0	440403	440229	1300	371	1300	401	1010
700	299	.0700.299.0	440404	440230	1600	429	1600	459	1010
800	51	.0800.051.0	440405	440231	915	346	915	376	1120
800	98	.0800.098.0	440406	440232	1045	376	1045	407	1120
800	151	.0800.151.0	440407	440233	1210	414	1210	442	1120
800	206	.0800.206.0	440408	440234	1410	457	1410	485	1120
800	303	.0800.303.0	440409	440235	1760	532	1760	560	1120
900	52	.0900.052.0	440410	440236	1015	539	1015	590	1285
900	97	.0900.097.0	440411	440237	1145	577	1145	630	1285
900	150	.0900.150.0	440412	440238	1395	645	1395	698	1285
900	197	.0900.197.0	440413	440239	1510	679	1510	731	1285
900	295	.0900.295.0	440414	440240	1910	786	1910	838	1285

# FOR MOVEMENT IN ONE PLANE TYPE LRN 06 ... FOR MOVEMENT IN ALL PLANES TYPE LRK 06 ...

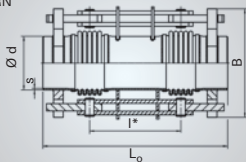
## PN 06

06

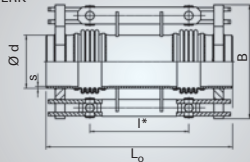
Centre-to-centre spacing of bellows	Weld end		Spring rate		
	outside diameter	wall thickness			
<b>l*</b>	<b>d</b>	<b>s</b>	<b>c<sub>r</sub></b>	<b>c<sub>s</sub></b>	<b>c<sub>p</sub></b>
<b>mm</b>	<b>mm</b>	<b>mm</b>	<b>N/bar</b>	<b>N/mm</b>	<b>N/mm bar</b>
363	610	8	427	430	6.9
418	610	8	369	193	8.6
568	610	8	272	105	4.7
768	610	8	201	57	2.5
1118	610	8	138	27	1.2
363	711	8	573	612	9.2
418	711	8	497	276	12
545	711	10	380	135	8.1
745	711	10	278	72	4.4
1045	711	10	198	37	2.2
383	813	10	708	1050	13
448	813	10	604	458	15
580	813	10	465	227	11
780	813	10	346	125	6.1
1130	813	10	239	60	2.9
433	914	10	997	1165	13
498	914	10	865	525	16
748	914	8	575	232	7.1
830	914	8	518	157	6.9
1230	914	8	349	71	3.1

# LATERAL EXPANSION JOINT WITH WELD ENDS

Type LRN



Type LRK



06

Nominal diameter	Nominal lateral movement absorption	Type LRN 06 ... LRK 06 ...	Order No. standard version		LRN		LRK		Max. width approx.
			LRN	LRK	overall length	weight approx.	overall length	weight approx.	
DN	$2\lambda_{\text{N}}$	—	—	—	$L_o$	G	$L_o$	G	B
—	mm	—	—	—	mm	kg	mm	kg	mm
1000	50	.1000.050.0	440415	440241	1035	595	1035	647	1395
1000	104	.1000.104.0	440416	440242	1220	652	1220	705	1395
1000	152	.1000.152.0	440417	440243	1390	704	1390	756	1395
1000	210	.1000.210.0	440418	440244	1640	778	1640	831	1395
1000	303	.1000.303.0	440419	440245	2040	895	2040	947	1395
1200	63	.1200.063.0	440420	440246	1155	820	1155	872	1615
1200	100	.1200.100.0	440421	440247	1320	885	1320	937	1615
1200	155	.1200.155.0	440422	440248	1540	968	1540	1020	1615
1200	206	.1200.206.0	440423	440249	1790	1068	1790	1121	1615
1200	308	.1200.308.0	440424	440250	2290	1266	2290	1318	1615
1400	49	.1400.049.0	440425	440251	1340	1161	1340	1281	1840
1400	97	.1400.097.0	440426	440252	1480	1190	1480	1311	1840
1400	149	.1400.149.0	440427	440253	1880	1386	1880	1507	1840
1400	202	.1400.202.0	440428	440254	2280	1586	2280	1706	1840
1400	307	.1400.307.0	440429	440255	3080	1981	3080	2102	1840
1600	47	.1600.047.0	440430	440256	1540	1723	1540	1926	2080
1600	103	.1600.103.0	440431	440257	1780	1817	1780	2019	2080
1600	147	.1600.147.0	440432	440258	2180	2062	2180	2264	2080
1600	190	.1600.190.0	440433	440259	2580	2307	2580	2510	2080
1600	300	.1600.300.0	440434	440260	3580	2915	3580	3117	2080

# FOR MOVEMENT IN ONE PLANE TYPE LRN 06 ... FOR MOVEMENT IN ALL PLANES TYPE LRK 06 ...

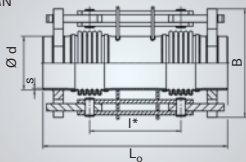
## PN 06

06

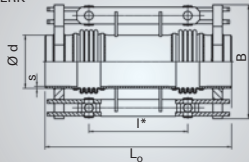
Centre-to-centre spacing of bellows	Weld end		Spring rate		
	outside diameter	wall thickness			
<b>l*</b>	<b>d</b>	<b>s</b>	<b>c<sub>1</sub></b>	<b>c<sub>2</sub></b>	<b>c<sub>3</sub></b>
<b>mm</b>	<b>mm</b>	<b>mm</b>	<b>N/bar</b>	<b>N/mm</b>	<b>N/mm bar</b>
443	1016	10	1196	1396	16
560	1016	10	940	517	16
695	1016	10	758	280	13
945	1016	10	558	152	6.9
1345	1016	10	392	75	3.4
478	1220	10	1556	1415	25
610	1220	10	1212	687	19
795	1220	10	930	337	14
1045	1220	10	708	195	7.9
1545	1220	10	479	89	3.6
720	1420	15	1848	1848	13
740	1420	15	1797	873	24
1140	1420	15	1167	368	10
1540	1420	15	864	202	5.6
2340	1420	15	569	88	2.4
820	1620	15	2625	2089	13
940	1620	15	2288	794	20
1340	1620	15	1606	391	9.6
1740	1620	15	1237	232	5.7
2740	1620	15	786	94	2.3

# LATERAL EXPANSION JOINT WITH WELD ENDS

Type LRN



Type LRK



06

Nominal diameter	Nominal lateral movement absorption	Type LRN 06 ... LRK 06 ...	Order No. standard version		LRN		LRK		Max. width approx.
			LRN	LRK	overall length	weight approx.	overall length	weight approx.	
DN	$2\lambda_{\text{N}}$	–	–	–	$L_0$	G	$L_0$	G	B
–	mm	–	–	–	mm	kg	mm	kg	mm
1800	63	.1800.063.0	440435	440261	1480	1789	1480	2106	2280
1800	102	.1800.102.0	440436	440262	1880	2055	1880	2372	2280
1800	150	.1800.150.0	440437	440263	2380	2385	2380	2702	2280
1800	199	.1800.199.0	440438	440264	2880	2718	2880	3036	2280
1800	307	.1800.307.0	440439	440265	3980	3445	3980	3762	2280
2000	57	.2000.057.0	440440	–	1580	2681	–	–	2575
2000	101	.2000.101.0	440441	–	2080	3104	–	–	2575
2000	146	.2000.146.0	440442	–	2580	3526	–	–	2575
2000	199	.2000.199.0	440443	–	3180	4034	–	–	2575
2000	306	.2000.306.0	440444	–	4380	5045	–	–	2575

# FOR MOVEMENT IN ONE PLANE TYPE LRN 06 ... FOR MOVEMENT IN ALL PLANES TYPE LRK 06 ...

## PN 06

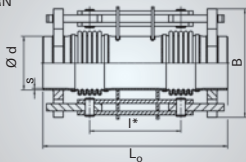
06

Centre-to-centre spacing of bellows	Weld end		Spring rate		
	outside diameter	wall thickness			
<b>l*</b>	<b>d</b>	<b>s</b>	<b>c<sub>r</sub></b>	<b>c<sub>s</sub></b>	<b>c<sub>p</sub></b>
mm	mm	mm	N/bar	N/mm	N/mm bar
640	1820	15	4219	2400	53
1040	1820	15	2598	910	20
1540	1820	15	1755	415	9.2
2040	1820	15	1325	237	5.2
3140	1820	15	861	100	2.2
640	2020	15	6472	3254	65
1140	2020	15	3637	1027	20
1640	2020	15	2529	497	9.9
2240	2020	15	1852	266	5.3
3440	2020	15	1206	113	2.3

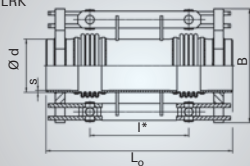


# LATERAL EXPANSION JOINT WITH WELD ENDS

Type LRN



Type LRK



Nominal diameter	Nominal lateral movement absorption	Type LRN 10 ... LRK 10 ...	Order No. standard version		LRN		LRK		Max. width approx.
			LRN	LRK	overall length	weight approx.	overall length	weight approx.	
DN	$2\lambda_{\text{N}}$	—	—	—	$L_0$	G	$L_0$	G	B
—	mm	—	—	—	mm	kg	mm	kg	mm
600	55	.0600.055.0	440445	440266	840	264	840	295	900
600	103	.0600.103.0	440446	440267	955	287	955	317	900
600	155	.0600.155.0	440447	440268	1155	322	1155	351	900
600	207	.0600.207.0	440448	440269	1355	356	1355	386	900
600	298	.0600.298.0	440449	440270	1705	417	1705	446	900
700	52	.0700.052.0	440450	440271	900	421	900	472	1065
700	111	.0700.111.0	440451	440272	1075	470	1075	521	1065
700	152	.0700.152.0	440452	440273	1190	501	1190	553	1065
700	208	.0700.208.0	440453	440274	1390	547	1390	600	1065
700	307	.0700.307.0	440454	440275	1740	627	1740	679	1065
800	51	.0800.051.0	440455	440276	970	508	970	559	1165
800	98	.0800.098.0	440456	440277	1105	552	1105	603	1165
800	150	.0800.150.0	440457	440278	1270	604	1270	655	1165
800	204	.0800.204.0	440458	440279	1470	662	1470	713	1165
800	299	.0800.299.0	440459	440280	1820	766	1820	817	1165
900	52	.0900.052.0	440460	440281	1070	655	1070	707	1315
900	97	.0900.097.0	440461	440282	1205	704	1205	756	1315
900	146	.0900.146.0	440462	440283	1370	760	1370	813	1315
900	194	.0900.194.0	440463	440284	1570	824	1570	876	1315
900	291	.0900.291.0	440464	440285	1970	953	1970	1005	1315

# FOR MOVEMENT IN ONE PLANE TYPE LRN 10 ... FOR MOVEMENT IN ALL PLANES TYPE LRK 10 ...

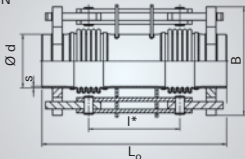
## PN 10

06

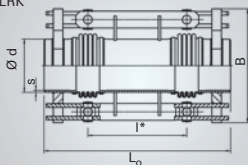
Centre-to-centre spacing of bellows	Weld end		Spring rate		
	outside diameter	wall thickness			
<b>l*</b>	<b>d</b>	<b>s</b>	<b>c<sub>r</sub></b>	<b>c<sub>s</sub></b>	<b>c<sub>p</sub></b>
<b>mm</b>	<b>mm</b>	<b>mm</b>	<b>N/bar</b>	<b>N/mm</b>	<b>N/mm bar</b>
365	610	10	424	662	7
423	610	10	366	296	8.7
623	610	10	248	136	4
823	610	10	188	78	2.3
1173	610	10	132	38	1.1
375	711	12	698	1123	10
488	711	12	535	396	9.7
570	711	12	458	242	8.6
770	711	12	339	133	4.7
1120	711	12	233	63	2.2
385	813	12	880	1384	13
453	813	12	748	600	16
585	813	12	577	297	11
785	813	12	430	165	6.2
1135	813	12	298	79	3
435	914	12	992	1538	13
503	914	12	858	690	16
635	914	12	677	358	12
835	914	12	515	207	7
1235	914	12	348	95	3.2

# LATERAL EXPANSION JOINT WITH WELD ENDS

Type LRN



Type LRK



06

Nominal diameter	Nominal lateral movement absorption	Type LRN 10 ... LRK 10 ...	Order No. standard version		LRN		LRK		Max. width approx.
			LRN	LRK	overall length	weight approx.	overall length	weight approx.	
DN	$2\lambda_{\text{N}}$	—	—	—	$L_0$	G	$L_0$	G	B
—	mm	—	—	—	mm	kg	mm	kg	mm
1000	58	.1000.058.0	440465	440286	1260	978	1260	1099	1450
1000	102	.1000.102.0	440466	440287	1480	1072	1480	1193	1450
1000	155	.1000.155.0	440467	440288	1705	1165	1705	1282	1450
1000	212	.1000.212.0	440468	440289	2005	1281	2005	1398	1450
1000	298	.1000.298.0	440469	440290	2455	1456	2455	1573	1450
1200	51	.1200.051.0	440470	440291	1260	1292	1260	1499	1680
1200	102	.1200.102.0	440471	440292	1505	1429	1505	1633	1680
1200	151	.1200.151.0	440472	440293	1805	1582	1805	1785	1680
1200	201	.1200.201.0	440473	440294	2105	1734	2105	1937	1680
1200	300	.1200.300.0	440474	440295	2705	2038	2705	2242	1680
1400	54	.1400.054.0	440475	—	1660	2226	—	—	1975
1400	106	.1400.106.0	440476	—	1815	2296	—	—	1975
1400	155	.1400.155.0	440477	—	2215	2572	—	—	1975
1400	204	.1400.204.0	440478	—	2615	2847	—	—	1975
1400	303	.1400.303.0	440479	—	3415	3402	—	—	1975

# FOR MOVEMENT IN ONE PLANE TYPE LRN 10 ... FOR MOVEMENT IN ALL PLANES TYPE LRK 10 ...

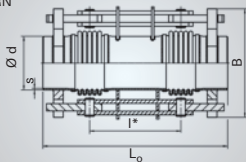
## PN 10

06

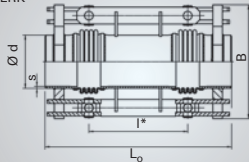
Centre-to-centre spacing of bellows	Weld end		Spring rate		
	outside diameter	wall thickness			
<b>l*</b>	<b>d</b>	<b>s</b>	<b>c<sub>r</sub></b>	<b>c<sub>s</sub></b>	<b>c<sub>p</sub></b>
<b>mm</b>	<b>mm</b>	<b>mm</b>	<b>N/bar</b>	<b>N/mm</b>	<b>N/mm bar</b>
480	1016	15	1478	1857	18
665	1016	15	1065	772	12
853	1016	15	833	393	8.8
1153	1016	15	616	215	4.8
1603	1016	15	443	111	2.5
480	1220	15	2587	3030	26
653	1220	15	1905	1095	21
953	1220	15	1305	513	9.9
1253	1220	15	992	297	5.7
1853	1220	15	671	136	2.6
830	1420	15	2516	2287	10
858	1420	15	2431	1068	19
1258	1420	15	1658	497	9.1
1658	1420	15	1258	286	5.2
2458	1420	15	848	130	2.4

# LATERAL EXPANSION JOINT WITH WELD ENDS

Type LRN



Type LRK



06

Nominal diameter	Nominal lateral movement absorption	Type LRN 16 ... LRK 16 ...	Order No. standard version		LRN		LRK		Max. width approx.
			LRN	LRK	overall length	weight approx.	overall length	weight approx.	
DN	$2\lambda_{\text{N}}$	—	—	—	$L_0$	G	$L_0$	G	B
—	mm	—	—	—	mm	kg	mm	kg	mm
500	53	.0500.053.0	440480	440296	810	250	810	280	790
500	107	.0500.107.0	440481	440297	945	276	945	306	790
500	148	.0500.148.0	440482	440298	1095	299	1095	328	790
500	203	.0500.203.0	440483	440299	1295	329	1295	359	790
500	313	.0500.313.0	440484	440300	1695	390	1695	419	790
600	53	.0600.053.0	440485	440301	945	393	945	443	945
600	99	.0600.099.0	440486	440302	1115	437	1115	487	945
600	150	.0600.150.0	440487	440303	1365	489	1365	539	945
600	202	.0600.202.0	440488	440304	1615	542	1615	592	945
600	305	.0600.305.0	440489	440305	2115	646	2115	696	945
700	54	.0700.054.0	440490	440306	1005	511	1005	562	1085
700	100	.0700.100.0	440491	440307	1180	564	1180	616	1085
700	151	.0700.151.0	440492	440308	1430	630	1430	682	1085
700	202	.0700.202.0	440493	440309	1680	696	1680	748	1085
700	304	.0700.304.0	440494	440310	2180	829	2180	881	1085
800	58	.0800.058.0	440495	440311	1120	764	1120	885	1220
800	105	.0800.105.0	440496	440312	1300	833	1300	954	1220
800	153	.0800.153.0	440497	440313	1550	918	1550	1039	1220
800	211	.0800.211.0	440498	440314	1850	1018	1850	1139	1220
800	307	.0800.307.0	440499	440315	2350	1188	2350	1309	1220

# FOR MOVEMENT IN ONE PLANE TYPE LRN 16 ... FOR MOVEMENT IN ALL PLANES TYPE LRK 16 ...

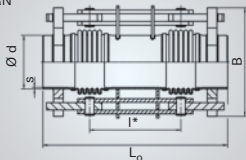
## PN 16

06

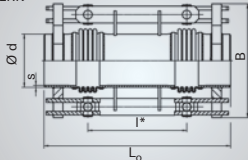
Centre-to-centre spacing of bellows	Weld end		Spring rate		
	outside diameter	wall thickness			
<b>l*</b>	<b>d</b>	<b>s</b>	<b>c<sub>1</sub></b>	<b>c<sub>2</sub></b>	<b>c<sub>3</sub></b>
<b>mm</b>	<b>mm</b>	<b>mm</b>	<b>N/bar</b>	<b>N/mm</b>	<b>N/mm bar</b>
338	508	10	325	714	5.6
418	508	10	262	279	6.1
568	508	10	193	151	3.3
768	508	10	143	83	1.8
1168	508	10	94	36	0.8
398	610	12	487	1103	8.2
508	610	12	382	451	7.5
758	610	12	256	203	3.4
1008	610	12	192	115	1.9
1508	610	12	129	51	0.9
403	711	12	651	1332	11
515	711	12	510	543	10
765	711	12	343	246	4.6
1015	711	12	258	140	2.6
1515	711	12	173	63	1.2
460	813	15	981	1375	11
575	813	15	786	589	11
825	813	15	548	286	5.3
1125	813	15	402	154	2.9
1625	813	15	278	74	1.4

# LATERAL EXPANSION JOINT WITH WELD ENDS

Type LRN



Type LRK



06

Nominal diameter	Nominal lateral movement absorption	Type LRN 16 ... LRK 16 ...	Order No. standard version		LRN		LRK		Max. width approx.
			LRN	LRK	overall length	weight approx.	overall length	weight approx.	
DN	$2\lambda_{\text{N}}$	—	—	—	$L_o$	G	$L_o$	G	B
—	mm	—	—	—	mm	kg	mm	kg	mm
900	52	.0900.052.0	440500	440316	1270	1155	1270	1362	1380
900	104	.0900.104.0	440501	440317	1455	1249	1455	1454	1380
900	157	.0900.157.0	440502	440318	1670	1349	1670	1556	1380
900	205	.0900.205.0	440503	440319	1920	1458	1920	1664	1380
900	293	.0900.293.0	440504	440320	2370	1651	2370	1857	1380
1000	51	.1000.051.0	440505	440321	1310	1279	1310	1488	1490
1000	102	.1000.102.0	440506	440322	1510	1397	1510	1603	1490
1000	154	.1000.154.0	440507	440323	1735	1510	1735	1716	1490
1000	210	.1000.210.0	440508	440324	2035	1647	2035	1853	1490
1000	303	.1000.303.0	440509	440325	2535	1873	2535	2078	1490

# FOR MOVEMENT IN ONE PLANE TYPE LRN 16 ... FOR MOVEMENT IN ALL PLANES TYPE LRK 16 ...

## PN 16

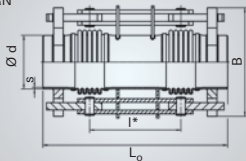
06

Centre-to-centre spacing of bellows	Weld end		Spring rate		
	outside diameter	wall thickness			
<b>l*</b>	<b>d</b>	<b>s</b>	<b>c<sub>r</sub></b>	<b>c<sub>s</sub></b>	<b>c<sub>p</sub></b>
<b>mm</b>	<b>mm</b>	<b>mm</b>	<b>N/bar</b>	<b>N/mm</b>	<b>N/mm bar</b>
535	914	15	1355	1878	8.6
653	914	15	1110	756	9.6
835	914	15	866	383	7
1085	914	15	667	227	4.2
1535	914	15	471	113	2.1
555	1016	15	1605	2466	11
680	1016	15	1308	982	12
868	1016	15	1024	502	9
1168	1016	15	761	277	5
1668	1016	15	533	136	2.4

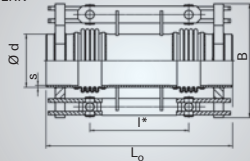


# LATERAL EXPANSION JOINT WITH WELD ENDS

Type LRN



Type LRK



06

Nominal diameter	Nominal lateral movement absorption	Type LRN 25 ... LRK 25 ...	Order No. standard version		LRN		LRK		Max. width approx.
			LRN	LRK	overall length	weight approx.	overall length	weight approx.	
DN	$2\lambda_{\text{N}}$	—	—	—	$L_0$	G	$L_0$	G	B
—	mm	—	—	—	mm	kg	mm	kg	mm
400	50	.0400.050.0	440510	440326	860	217	860	247	680
400	100	.0400.100.0	440511	440327	1110	251	1110	281	680
400	153	.0400.153.0	440512	440328	1310	280	1310	310	680
400	203	.0400.203.0	440513	440329	1560	313	1560	343	680
400	295	.0400.295.0	440514	440330	2010	372	2010	401	680
450	51	.0450.051.0	440515	440331	905	331	905	382	785
450	103	.0450.103.0	440516	440332	1110	373	1110	424	785
450	154	.0450.154.0	440517	440333	1360	417	1360	468	785
450	195	.0450.195.0	440518	440334	1560	452	1560	502	785
450	297	.0450.297.0	440519	440335	2060	544	2060	595	785
500	53	.0500.053.0	440520	440336	965	385	965	436	845
500	105	.0500.105.0	440521	440337	1220	439	1220	490	845
500	150	.0500.150.0	440522	440338	1380	476	1380	528	845
500	202	.0500.202.0	440523	440339	1630	523	1630	575	845
500	305	.0500.305.0	440524	440340	2130	616	2130	668	845
600	49	.0600.049.0	440525	440341	1085	624	1085	745	1000
600	98	.0600.098.0	440526	440342	1240	684	1240	805	1000
600	151	.0600.151.0	440527	440343	1455	751	1455	872	1000
600	202	.0600.202.0	440528	440344	1705	823	1705	944	1000
600	303	.0600.303.0	440529	440345	2205	967	2205	1088	1000
700	51	.0700.051.0	440530	440346	1185	931	1185	1137	1150
700	103	.0700.103.0	440531	440347	1420	1030	1420	1235	1150
700	150	.0700.150.0	440532	440348	1670	1121	1670	1326	1150
700	207	.0700.207.0	440533	440349	1970	1234	1970	1439	1150
700	301	.0700.301.0	440534	440350	2470	1425	2470	1630	1150

# FOR MOVEMENT IN ONE PLANE TYPE LRN 25 ... FOR MOVEMENT IN ALL PLANES TYPE LRK 25 ...

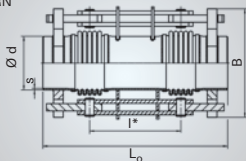
## PN 25

06

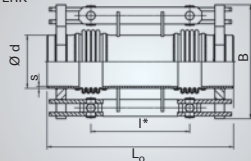
Centre-to-centre spacing of bellows	Weld end		Spring rate		
	outside diameter	wall thickness			
<b>l*</b>	<b>d</b>	<b>s</b>	<b>c<sub>1</sub></b>	<b>c<sub>2</sub></b>	<b>c<sub>3</sub></b>
mm	mm	mm	N/bar	N/mm	N/mm bar
375	406.4	10	189	639	3.5
600	406.4	10	118	199	1.7
775	406.4	10	91	100	1.2
1025	406.4	10	69	57	0.7
1475	406.4	10	48	27	0.3
378	457	10	293	794	4.5
530	457	10	209	269	3.4
780	457	10	142	124	1.6
980	457	10	113	79	1
1480	457	10	75	35	0.4
408	508	12	338	999	5.6
635	508	12	216	325	2.8
765	508	12	179	187	2.3
1015	508	12	135	106	1.3
1515	508	12	91	48	0.6
483	610	15	541	1238	4.5
595	610	15	437	486	4.9
778	610	15	335	238	3.4
1028	610	15	253	136	2
1528	610	15	171	62	0.9
418	711	15	1046	1757	11
585	711	15	748	600	8.5
835	711	15	524	294	4.1
1135	711	15	385	159	2.2
1635	711	15	267	77	1.1

# LATERAL EXPANSION JOINT WITH WELD ENDS

Type LRN



Type LRK



Nominal diameter	Nominal lateral movement absorption	Type LRN 40 ... LRK 40 ...	Order No. standard version		LRN		LRK		Max. width approx.
			LRN	LRK	overall length	weight approx.	overall length	weight approx.	
DN	$2\lambda_{\text{N}}$	—	—	—	$L_0$	G	$L_0$	G	B
—	mm	—	—	—	mm	kg	mm	kg	mm
300	52	.0300.052.0	440535	440351	855	195	855	228	580
300	101	.0300.101.0	440536	440352	1045	219	1045	252	580
300	147	.0300.147.0	440537	440353	1295	248	1295	281	580
300	194	.0300.194.0	440538	440354	1545	276	1545	309	580
300	297	.0300.297.0	440539	440355	2095	339	2095	372	580
350	51	.0350.051.0	440540	440356	915	278	915	328	675
350	106	.0350.106.0	440541	440357	1135	316	1135	366	675
350	155	.0350.155.0	440542	440358	1385	355	1385	405	675
350	204	.0350.204.0	440543	440359	1635	393	1635	444	675
350	301	.0350.301.0	440544	440360	2135	471	2135	522	675
400	50	.0400.050.0	440545	440361	915	321	915	392	725
400	99	.0400.099.0	440546	440362	1170	371	1170	442	725
400	149	.0400.149.0	440547	440363	1370	410	1370	481	725
400	198	.0400.198.0	440548	440364	1620	455	1620	526	725
400	296	.0400.296.0	440549	440365	2120	552	2120	623	725
450	49	.0450.049.0	440550	440366	945	384	945	435	815
450	107	.0450.107.0	440551	440367	1210	445	1210	496	815
450	154	.0450.154.0	440552	440368	1460	495	1460	545	815
450	201	.0450.201.0	440553	440369	1710	545	1710	596	815
450	304	.0450.304.0	440554	440370	2260	655	2260	705	815
500	47	.0500.047.0	440555	440371	1140	588	1140	710	890
500	96	.0500.096.0	440556	440372	1405	664	1405	786	890
500	146	.0500.146.0	440557	440373	1755	755	1755	877	890
500	196	.0500.196.0	440558	440374	2105	846	2105	968	890
500	296	.0500.296.0	440559	440375	2805	1028	2805	1150	890

# FOR MOVEMENT IN ONE PLANE TYPE LRN 40 ... FOR MOVEMENT IN ALL PLANES TYPE LRK 40 ...

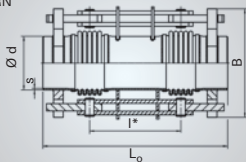
## PN 40

06

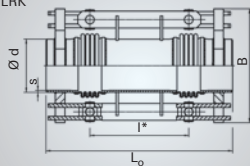
Centre-to-centre spacing of bellows	Weld end		Spring rate		
	outside diameter	wall thickness			
<b>l*</b>	<b>d</b>	<b>s</b>	<b>c<sub>1</sub></b>	<b>c<sub>2</sub></b>	<b>c<sub>3</sub></b>
<b>mm</b>	<b>mm</b>	<b>mm</b>	<b>N/bar</b>	<b>N/mm</b>	<b>N/mm bar</b>
418	323.9	7.1	109	407	1.7
563	323.9	7.1	81	149	1.4
813	323.9	7.1	56	71	0.7
1063	323.9	7.1	43	42	0.4
1613	323.9	7.1	28	18	0.2
395	355.6	8	173	479	2.3
568	355.6	8	120	155	1.7
818	355.6	8	84	75	0.8
1068	355.6	8	64	44	0.5
1568	355.6	8	44	20	0.2
383	406.4	10	233	669	3.7
610	406.4	10	146	210	1.8
785	406.4	10	113	105	1.3
1035	406.4	10	86	61	0.7
1535	406.4	10	58	28	0.3
398	457	10	281	917	4.5
605	457	10	184	264	2.9
855	457	10	131	132	1.5
1105	457	10	101	79	0.9
1655	457	10	67	35	0.4
495	508	12	370	1142	3.6
703	508	12	261	377	2.7
1053	508	12	174	168	1.2
1403	508	12	130	95	0.7
2103	508	12	87	42	0.3

# LATERAL EXPANSION JOINT WITH WELD ENDS

Type LRN



Type LRK



06

Nominal diameter	Nominal lateral movement absorption	Type LRN 63 ... LRK 63 ...	Order No. standard version		LRN		LRK		Max. width approx.
			LRN	LRK	overall length	weight approx.	overall length	weight approx.	
DN	$2\lambda_{\text{N}}$	—	—	—	$L_0$	G	$L_0$	G	B
—	mm	—	—	—	mm	kg	mm	kg	mm
250	51	.0250.051.0	440560	440376	920	207	920	240	575
250	104	.0250.104.0	440561	440377	1215	243	1215	276	575
250	153	.0250.153.0	440562	440378	1515	279	1515	312	575
250	202	.0250.202.0	440563	440379	1815	314	1815	347	575
300	48	.0300.048.0	440564	440380	950	304	950	354	625
300	100	.0300.100.0	440565	440381	1200	350	1200	400	625
300	150	.0300.150.0	440566	440382	1500	401	1500	451	625
300	200	.0300.200.0	440567	440383	1800	453	1800	503	625
300	299	.0300.299.0	440568	440384	2400	556	2400	606	625
350	49	.0350.049.0	440569	440385	1045	367	1045	401	695
350	97	.0350.097.0	440570	440386	1260	415	1260	449	695
350	147	.0350.147.0	440571	440387	1560	473	1560	507	695
350	198	.0350.198.0	440572	440388	1860	530	1860	564	695
350	299	.0350.299.0	440573	440389	2460	644	2460	678	695
400	52	.0400.052.0	440574	440390	1170	555	1170	671	780
400	102	.0400.102.0	440575	440391	1520	652	1520	768	780
400	152	.0400.152.0	440576	440392	1920	762	1920	879	780
400	196	.0400.196.0	440577	440393	2270	861	2270	978	780
400	297	.0400.297.0	440578	440394	3070	1087	3070	1204	780

# FOR MOVEMENT IN ONE PLANE TYPE LRN 63 ... FOR MOVEMENT IN ALL PLANES TYPE LRK 63 ...

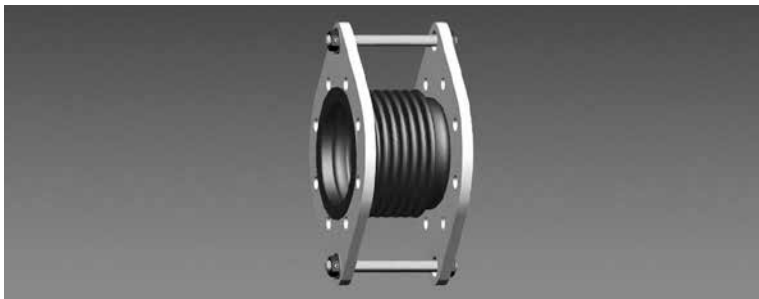
## PN 63

06

Centre-to-centre spacing of bellows	Weld end		Spring rate		
	outside diameter	wall thickness			
I*	d	s	c <sub>1</sub>	c <sub>2</sub>	c <sub>3</sub>
mm	mm	mm	N/bar	N/mm	N/mm bar
385	273	8.8	86	357	1.8
658	273	8.8	50	102	0.7
958	273	8.8	34	48	0.3
1258	273	8.8	26	28	0.2
425	323.9	10	135	448	1.8
625	323.9	10	91	138	1.2
925	323.9	10	62	63	0.6
1225	323.9	10	47	36	0.3
1825	323.9	10	31	16	0.1
448	355.6	12	156	605	2.2
605	355.6	12	115	221	1.8
905	355.6	12	77	99	0.8
1205	355.6	12	58	56	0.5
1805	355.6	12	39	25	0.2
510	406.4	15	233	621	2.6
835	406.4	15	142	192	1.1
1235	406.4	15	96	88	0.5
1585	406.4	15	75	53	0.3
2385	406.4	15	50	24	0.1

# LATERAL EXPANSION JOINTS WITH LOOSE FLANGES, SOUND INSULATING TYPE LBS

06



## Type designation

The type designation consists of 2 parts

1. Type series, defined by 3 letters
2. Nominal size, defined by 10 digits

## Example

Type LBS: HYDRA sound insulating lateral expansion joint for absorbing vibration, with loose flanges

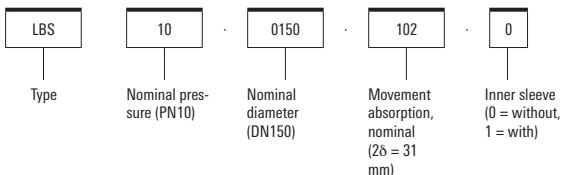
## Standard version/materials:

Multi-ply bellows made of 1.4541

Flange made of P 265 GH (1.0425)

Operating temperature: up to 400 °C

## Type designation (example)



## Order text according to guideline 2014/68/EU "Pressure Equipment Directive"

Please state the following with your order:

For standard versions

- Type designation or order number

With material variation

- Type designation
- Details of the materials

According to the Pressure Equipment Directive, the following information is required for testing and documentation:

06

Type of pressure equipment according to Art. 1 & 2:

- Vessel - volume V [l] \_\_\_\_\_
- Piping - nominal diameter DN \_\_\_\_\_

Medium property according to Art. 13:

- Group 1 – dangerous
- Group 2 – all other fluids

State of medium

- Gaseous or liquid if PD > 0.5 bar
- Liquid if PD ≤ 0.5 bar

Design data:

- Max. allowable pressure [bar] \_\_\_\_\_
- Max./min. allowable temperature [°C] \_\_\_\_\_
- Test pressure PT [bar] \_\_\_\_\_

Optional:

- Category \_\_\_\_\_

### Note

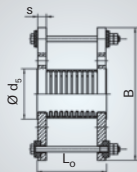
Tell us the dimensions that deviate from the standard and we customize the expansion joint to your specification.

On request, flanges can also be supplied with other hole patterns / flange sheet thicknesses. In this case, the specified overall length L0 may change.



# LATERAL EXPANSION JOINTS WITH LOOSE FLANGES, SOUND INSULATING

Type LBS



06

Nominal diameter	Nominal lateral movement absorption		Type LBS 06...	Order No. standard version	Overall length	Weight approx.	Max. width approx.
	for 1000 load cycles	with vibrations					
DN	$2\lambda_{-N}$	$\hat{i}$	–	–	$L_0$	G	B
–	mm	mm	–	–	mm	kg	mm
50	18	0.5	.0050.018	459873	165	6	240
65	20	0.5	.0065.020	459874	180	7	260
80	21	0.5	.0080.021	459875	190	10	290
100	20	0.5	.0100.020	459876	190	11	310
125	19	0.5	.0125.019	459877	210	15	340
150	31	0.5	.0150.031	459878	265	17	365
200	32	0.5	.0200.032	459879	285	24	420
250	36	0.5	.0250.036	459880	330	39	503
300	40	0.5	.0300.040	459881	345	55	600
350	38	0.5	.0350.038	459882	360	69	650
400	31	0.5	.0400.031	459883	390	89	724

# TYPE LBS 06 ... PN 06

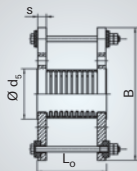
06

Flange <sup>2)</sup>			Spring rate			Natural frequency of bellows	
drilling DIN 1092	flange diameter	thickness				axial	radial
PN	d <sub>s</sub>	s	c <sub>r</sub>	c <sub>λ</sub>	c <sub>p</sub>	ω <sub>α</sub>	ω <sub>r</sub>
–	mm	mm	N/bar	N/mm	N/mm bar	Hz	Hz
06	90	16	6	77	0	200	385
06	107	16	8.7	91	0	155	340
06	122	18	11	99	0	145	325
06	147	18	17	162	0	125	345
06	178	20	21	212	0	115	355
06	202	20	25	117	0	90	355
06	258	22	48	165	0	75	325
06	312	24	83	298	0	55	285
06	365	24	153	358	0	50	250
06	410	26	179	418	0	50	270
06	465	28	268	501	0	55	335

2) Available with other hole patterns / thicknesses on request. The overall length L0 may change then.

# LATERAL EXPANSION JOINTS WITH LOOSE FLANGES, SOUND INSULATING

Type LBS



06

Nominal diameter	Nominal lateral movement absorption		Type LBS 10...	Order No. standard version	Overall length	Weight approx.	Max. width approx.
	for 1000 load cycles	with vibrations					
DN	$2\lambda_{-N}$	$\hat{i}$	–	–	$L_0$	G	B
–	mm	mm	–	–	mm	kg	mm
50	18	0.5	.0050.018	459885	175	9	265
65	20	0.5	.0065.020	459886	200	12	285
80	21	0.5	.0080.021	459887	210	13	300
100	20	0.5	.0100.020	459888	210	15	320
125	19	0.5	.0125.019	459889	215	19	350
150	31	0.5	.0150.031	459890	285	26	385
200	32	0.5	.0200.032	459891	300	35	468
250	36	0.5	.0250.036	459892	345	54	555
300	40	0.5	.0300.040	459893	370	77	629
350	38	0.5	.0350.038	459895	380	93	689
400	31	0.5	.0400.031	459896	430	152	785

# TYPE LBS 10 ... PN 10

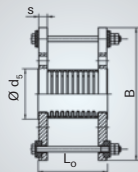
06

Flange <sup>2)</sup>			Spring rate			Natural frequency of bellows	
drilling DIN 1092	flange diameter	thickness				axial	radial
PN	d <sub>s</sub>	s	c <sub>r</sub>	c <sub>λ</sub>	c <sub>p</sub>	ω <sub>α</sub>	ω <sub>r</sub>
–	mm	mm	N/bar	N/mm	N/mm bar	Hz	Hz
16	92	19	5.7	77	0	200	385
16	107	20	8.1	136	0	160	315
16	122	20	10	146	0	150	305
16	147	22	16	236	0	125	325
16	178	22	20	364	0	115	355
16	208	24	29	191	0	90	335
10	258	24	58	266	0	75	315
10	320	26	113	339	0	55	260
10	370	28	178	532	0	45	225
10	410	28	213	620	0	40	210
10	465	37	289	1003	0	55	305

2) Available with other hole patterns / thicknesses on request. The overall length L0 may change then.

# LATERAL EXPANSION JOINTS WITH LOOSE FLANGES, SOUND INSULATING

Type LBS



06

Nominal diameter	Nominal lateral movement absorption		Type LBS 16...	Order No. standard version	Overall length	Weight approx.	Max. width approx.
	for 1000 load cycles	with vibrations					
DN	$2\lambda_{-N}$	$\hat{i}$	–	–	$L_0$	G	B
–	mm	mm	–	–	mm	kg	mm
50	18	0.5	.0050.017	459898	185	10	265
65	20	0.5	.0065.022	459899	210	12	285
80	21	0.5	.0080.020	459900	210	13	300
100	20	0.5	.0100.015	459901	200	16	320
125	19	0.5	.0125.015	459902	210	19	350
150	31	0.5	.0150.032	459903	290	29	413
200	32	0.5	.0200.033	459904	310	47	500
250	36	0.5	.0250.025	459905	355	73	589
300	40	0.5	.0300.027	459906	385	110	680
350	38	0.5	.0350.025	459907	380	151	667
400	31	0.5	.0400.033	459908	450	193	723

# TYP LBS 16 ... PN 16

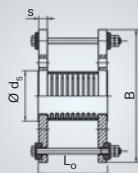
06

Flange <sup>2)</sup>			Spring rate			Natural frequency of bellows	
drilling DIN 1092	flange diameter	thickness				axial	radial
PN	d <sub>s</sub>	s	c <sub>r</sub>	c <sub>λ</sub>	c <sub>p</sub>	ω <sub>α</sub>	ω <sub>r</sub>
–	mm	mm	N/bar	N/mm	N/mm bar	Hz	Hz
16	92	19	5.5	119	0	205	360
16	107	20	7.8	130	0	140	260
16	122	20	10	178	0	145	300
16	147	22	16	402	0	135	390
16	178	22	25	573	0	130	425
16	208	24	36	220	0	90	315
16	258	26	78	421	0	70	285
16	320	32	133	499	0	85	410
16	375	37	199	741	0	70	360
16	410	32	214	1035	0	65	350
16	465	34	250	1192	0	55	275

2) Available with other hole patterns / thicknesses on request. The overall length L0 may change then.

# LATERAL EXPANSION JOINTS WITH LOOSE FLANGES, SOUND INSULATING

Type LBS



06

Nominal diameter	Nominal lateral movement absorption		Type LBS 25...	Order No. standard version	Overall length	Weight approx.	Max. width approx.
	for 1000 load cycles	with vibrations					
DN	$2\lambda_{-N}$	$\hat{i}$	–	–	$L_0$	G	B
–	mm	mm	–	–	mm	kg	mm
50	18	0.5	.0050.018	459909	190	10	265
65	20	0.5	.0065.020	459911	215	14	285
80	21	0.5	.0080.021	459912	215	16	300
100	20	0.5	.0100.020	459913	215	20	335
125	19	0.5	.0125.019	459914	230	30	398
150	31	0.5	.0150.031	459915	300	43	460
200	32	0.5	.0200.032	459916	325	66	544
250	36	0.5	.0250.036	459918	370	129	578
300	40	0.5	.0300.040	459919	405	164	634
350	38	0.5	.0350.038	459920	420	242	735

# TYP LBS 25 ... PN 25

06

Flange <sup>2)</sup>			Spring rate			Natural frequency of bellows	
drilling DIN 1092	flange diameter	thickness				axial	radial
PN	d <sub>s</sub>	s	c <sub>r</sub>	c <sub>λ</sub>	c <sub>p</sub>	ω <sub>α</sub>	ω <sub>r</sub>
–	mm	mm	N/bar	N/mm	N/mm bar	Hz	Hz
40	92	20	5.5	159	0	225	400
40	107	22	7.5	205	0	160	295
40	122	24	9.8	289	0	155	325
40	147	24	19	476	0	135	380
40	178	26	30	671	0	135	410
40	208	28	48	310	0	90	315
25	258	32	94	592	0	105	425
25	320	35	128	788	0	85	390
25	375	38	171	1344	0	75	340
25	410	42	223	1354	0	65	310

2) Available with other hole patterns / thicknesses on request. The overall length L0 may change then.



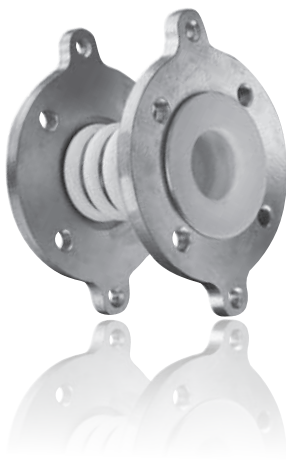
# SPECIAL RANGES



07



The standard ranges described in Chapter 6 are supplemented in this chapter by a series of special ranges of expansion joints and related products. These products are primarily designed either for special applications – engine manufacturing, apparatus construction, district heating – or for special performance data, e.g. high pressures. Type series are available for the more frequently demanded dimension ranges. Special designs outside these ranges can be supplied on request. The following pages provide a quick overview of the special ranges.



## Exhaust expansion joints with special cuffs

**Series**

various

**Nominal diameters**

DN 20-200

**Pressure ratings**

PN1



07

## Single-ply expansion joints for apparatus construction

**Series**

AON

**Nominal diameters**

DN 100-3000

**Pressure stages**

dependent on nominal diameter



## Axial expansion joints with PTFE lining

**Series**

ABT

**Nominal diameters**

DN 50-500

DN 50-300

**Pressure stages**

PN10 and PN25



## Axial expansion joints with automatic release mechanism

### Series

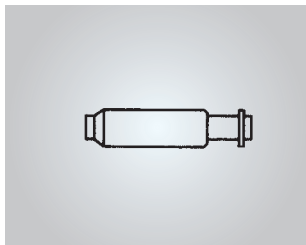
ARH

### Nominal diameters

DN 40-1000

### Pressure stages

PN 16 and PN 25



07

## Pressure balanced axial expansion joints

### Series

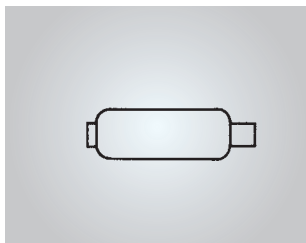
DRD

### Nominal diameters

DN 400-1000

### Pressure stages

PN 25 and PN 40



## Rectangular expansion joints

### Series

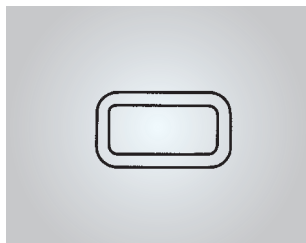
XOZ etc.

### Nominal diameters

Max. length of side b = 3700

### Pressure stages

Max. PS = 2 bar



## Axial expansion joints for vacuum technology

### Series

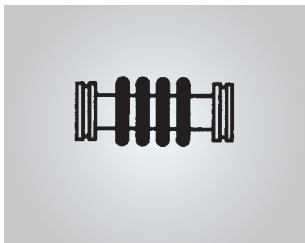
AVZ

### Nominal diameters

DN 16-500

### Pressure stages

PN 1



07

## Axial expansion joints for heating and ventilation installations

### Series

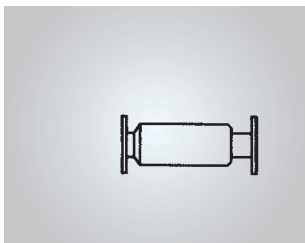
various

### Nominal diameters

DN 15-100

### Pressure stages

PN 6-25



## Expansion joints and metal bellows for high pressures

### Series

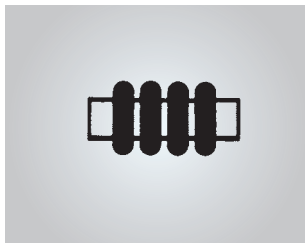
various

### Nominal diameters

DN 10-1000

### Pressure stages

Max. PN 400



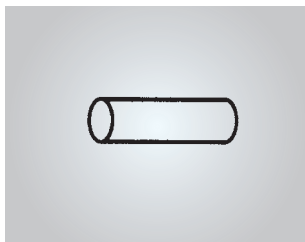
07

---

## Thin-walled pipes

### Diameter

$d_i = 40-1000$



## EXHAUST EXPANSION JOINTS WITH SPECIAL CUFFS

Special conditions apply to exhaust expansion joints that must be mounted directly at the engine:

- High temperatures ( $t > 400\text{ °C}$ )
- Temperature peaks, according to engine output
- Absorption of thermal expansion and sustained vibrations
- Compact dimensions, because of restricted space
- Assembly and disassembly must be rapid if the engine needs to be overhauled or repaired

To meet these requirements we supply special designs based on existing tool series, which are tailored to specific applications and have in some cases been developed jointly with the engine manufacturers.

Special tools can also be manufactured if necessary. When developing new designs, we are able to make use of our wide-ranging experience and our specially adapted testing facilities, which is an advantage with regard to both development times and costs.



Fig. 7.1 Exhaust expansion joints with special cuffs

## Assembly of exhaust expansion joints

The requirement for simple installation is met by special installation cuffs (see Figs. 7.2 and 7.3).

The moVix connection is a quick-fixing device developed by Witzenmann, which uses a wire-mesh ring made of heat-resistant material to seal and secure. This ring is press-fitted together with the conical cuff of the bellows by means of a V-band clamp. An unmachined pipe is a sufficient counterpart (Fig. 7.4).

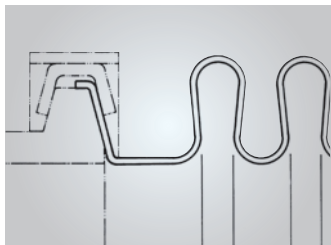


Fig. 7.2 Conical cuff for V-band clamp

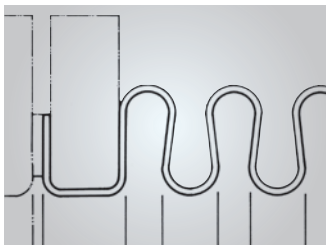


Fig. 7.3 Flange cuff for split flanges

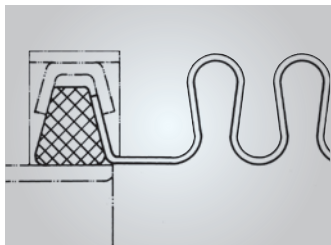


Fig. 7.4 moVix connection



# SINGLE PLY EXPANSION JOINTS FOR APPARATUS CONSTRUCTION

The special range of single ply expansion joints designed for apparatus and vessel construction meets the special demands of these fields to a special degree.

- Thick single ply for welding direct to the vessel wall
- Good lateral rigidity, which supersedes axial guidance in the vessel
- Small corrugations without circumferential welds for optimum overall dimensions



Fig. 7.7 Single ply expansion joint without connection parts

## Design and choice of expansion joints

The values in the table apply to one corrugation. The required number of corrugations  $n_w$  is dependent on the required movement.

### Number of corrugations $n_w$

$$(7.1) \quad n_w = 2\delta_{RT} / 2\delta_{WN}$$

Movement absorption, cold  $2\delta_{RT}$

Movement absorption per corrugation  $2\delta_{WN}$

(see table for nominal movement)

The nominal movement, total length and spring rate of the multi-corrugation expansion joint are dependent on the selected number of corrugations (rounded up to integer number).

## Nominal deflection $2\delta_N$ in mm

$$(7.2) \quad 2\delta_N = 2\delta_{WN} \cdot n_W$$

(rounded down to whole mm)

## Overall length $L_0$ in mm

$$(7.3) \quad L_0 = l_W \cdot n_W + 2l_B$$

Length of single corrugation  $l_W$  in mm

Length of cuff  $l_B$  in mm

## Spring rate of single bellows $c_\delta$ in N/mm

$$(7.4) \quad c_\delta = c_{\delta W} / n_W$$

Spring rate of the single corrugation  $c_{\delta W}$  in N/mm

The cuff diameter  $d_B$  can be adapted to the available connections. The dimension tables specify the permissible diameter range. Please indicate the desired dimension in the order.

**It should be noted** that the cylindrical section of the cuff IBZ should be at least 10 mm long on account of the production technology used. The length of transition zone must be between 4 mm and  $l_W/2$ .

For use in systems subject to approval, preliminary examination, acceptance test, certification and documentation must be agreed upon when the order is placed.

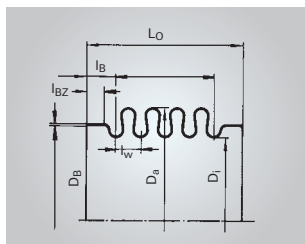


Fig. 7.8 Dimensions/descriptions

# SINGLE PLY EXPANSION JOINTS FOR APPARATUS CONSTRUCTION TYPE AON

07



## Type designation

The type designation consists of 2 parts

1. Type series, defined by 3 letters
2. Nominal size, defined by 9 digits

## Example

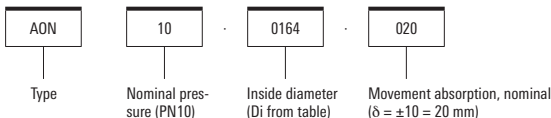
Type AON: HYDRA single ply expansion joint for apparatus construction

## Standard design/materials

Single ply bellows made of 1.4541

Operating temperature: up to 550 °C

## Type designation (example)



## Order text according to guideline 2014/68/EU "Pressure Equipment Directive"

Please state the following with your order:

For standard versions

- Type designation or order number

With material variation

- Type designation
- Details of the materials

According to the Pressure Equipment Directive, the following information is required for testing and documentation:

Type of pressure equipment according to Art. 1 & 2:

- Vessel - volume V [l] \_\_\_\_\_
- Piping - nominal diameter DN \_\_\_\_\_

Medium property according to Art. 13:

- Group 1 – dangerous
- Group 2 – all other fluids

State of medium

- Gaseous or liquid if PD > 0.5 bar
- Liquid if PD ≤ 0.5 bar

Design data:

- Max. allowable pressure [bar] \_\_\_\_\_
- Max./min. allowable temperature [°C] \_\_\_\_\_
- Test pressure PT [bar] \_\_\_\_\_

Optional:

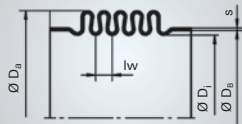
- Category \_\_\_\_\_

### Note

Tell us the dimensions that deviate from the standard and we customize the expansion joint to your specification.

# SINGLE PLY EXPANSION JOINTS FOR APPARATUS CONSTRUCTION

Type AON



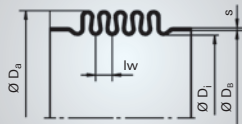
07

Nominal diameter	Nominal pressure	Nominal axial movement absorption per corrugation	Type AON ...	Weight per corrugation approx.	Bellows		
					wall thickness	diameter	
						inside	outside
DN	PN	$2\Delta_{WN}$	—	$G_w$	s	$D_i$	$D_a$
—	—	mm	—	kg	mm	mm	mm
100	25	1.9	25.0110.	0.1	1	110	145
100	50	1.3	50.0110.	0.2	1.5	110	146
125	20	2.5	20.0135.	0.2	1	135	175
125	40	1.7	40.0135.	0.2	1.5	135	176
150	10	4	10.0164.	0.2	1	164	216
150	20	2.7	20.0164.	0.4	1.5	164	216
150	50	1.9	50.0164.	0.5	2	164	215
200	6	5.8	06.0214.	0.4	1	214	276
200	16	4	16.0214.	0.6	1.5	214	278
200	32	2.8	32.0214.	0.7	2	214	275
250	6	7	06.0268.	0.5	1	268	336
250	12.5	4.4	12.0268.	0.8	1.5	268	334
250	25	3.4	25.0268.	1	2	268	336
250	63	2.2	63.0268.	1.5	3	268	336
300	5	8.4	05.0318.	0.7	1	318	392
300	10	5.6	10.0318.	1	1.5	318	392
300	20	4.2	20.0318.	1.3	2	318	393
300	50	2.8	50.0318.	2	3	318	393
350	4	9.6	04.0350.	0.8	1	350	429
350	10	6.4	10.0350.	1.2	1.5	350	429
350	16	4.6	16.0350.	1.6	2	350	428
350	50	3	50.0350.	2.3	3	350	426

Bellows					Spring rate axial per corrugation
corrugated length of a corrugation	cuff diameter		maximum number of corrugations	effective cross-section	
	inside	outside			
$l_w$	$D_{B \min.}$	$D_{B \max.}$	$n_w$	A	$C_{0W}$
mm	mm	mm	—	cm <sup>2</sup>	N/mm
12	112	143	9	128	7400
13	112	143	7	129	20500
14	137	173	10	189	5960
15	137	173	6	190	18600
15	166	214	11	284	3370
16	166	213	8	284	11400
17	166	211	8	282	25700
17	216	274	15	471	2500
18	216	275	15	475	7900
19	216	271	16	470	19200
19	271	334	14	716	2400
20	271	331	15	712	8550
21	271	332	14	716	20000
22	271	330	15	716	60500
20	321	390	13	990	2150
21	321	389	13	990	7200
22	321	389	13	993	17300
24	321	387	13	993	52000
21	353	427	12	1192	1950
22	353	426	12	1192	6500
23	353	424	12	1188	16900
25	353	420	13	1182	54000

# SINGLE PLY EXPANSION JOINTS FOR APPARATUS CONSTRUCTION

Type AON



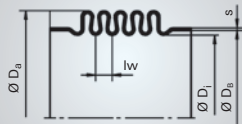
Nominal diameter	Nominal pressure	Nominal axial movement absorption per corrugation	Type AON ...	Weight per corrugation approx.	Bellows		
					wall thickness	diameter	
						inside	outside
DN	PN	$2\Delta_{WN}$	—	$G_w$	s	$D_i$	$D_a$
—	—	mm	—	kg	mm	mm	mm
400	4	10	04.0400.	0.9	1	400	480
400	8	7.2	08.0400.	1.4	1.5	400	484
400	16	5.6	16.0400.	2	2	400	486
400	40	3.8	40.0400.	2.9	3	400	486
450	5	10	05.0451.	1	1	451	530
450	10	6.6	10.0451.	1.5	1.5	451	530
450	16	4.8	16.0451.	2	2	451	530
450	40	3.4	40.0451.	3.1	3	451	530
500	3.2	13.6	03.0502.	1.3	1	502	595
500	8	8.8	08.0502.	2	1.5	502	595
500	12.5	6	12.0502.	2.5	2	502	590
500	32	4.4	32.0502.	3.9	3	502	593
550	6	8.4	06.0552.	1.2	1	552	622
550	12.5	5.8	12.0552.	1.8	1.5	552	624
550	20	4.2	20.0552.	2.3	2	552	623
550	40	3	40.0552.	3.6	3	552	626
600	3.2	14.4	03.0603.	1.6	1	603	698
600	6	9.2	06.0603.	2.4	1.5	603	697
600	12.5	6.6	12.0603.	3.2	2	603	695
600	32	4.2	32.0603.	4.6	3	603	692
700	2.5	16.6	02.0704.	2.1	1	704	807
700	6	12.6	06.0704.	3.2	1.5	704	810
700	10	7.8	10.0704.	4	2	704	804
700	25	5.2	25.0704.	6.1	3	704	806

Bellows					Spring rate axial per corrugation
corrugated length of a corrugation	cuff diameter		maximum number of corrugations	effective cross-section	
	inside	outside			
$l_w$	$D_{B \min.}$	$D_{B \max.}$	$n_w$	A	$C_{0W}$
mm	mm	mm	—	cm <sup>2</sup>	N/mm
22	403	478	12	1521	2100
23	403	481	11	1534	6000
24	403	482	11	1541	14100
26	403	480	11	1541	42000
24	454	528	12	1890	2350
24	454	527	12	1890	7900
25	454	526	12	1890	19800
27	454	524	12	1890	58000
24	505	593	10	2363	1600
25	505	592	10	2363	5500
26	505	586	11	2341	15800
28	505	587	11	2354	43000
25	556	620	13	2706	3800
25	556	621	13	2715	12000
26	556	619	13	2711	31300
28	556	620	13	2725	85000
26	607	696	10	3323	1800
26	607	694	10	3318	6200
27	607	691	10	3308	16400
29	607	686	10	3293	53700
27	708	805	9	4483	1600
28	708	807	9	4501	5100
29	708	800	9	4465	14800
31	708	800	9	4477	48800



# SINGLE PLY EXPANSION JOINTS FOR APPARATUS CONSTRUCTION

Type AON

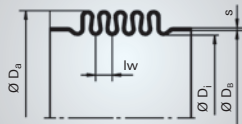


Nominal diameter	Nominal pressure	Nominal axial movement absorption per corrugation	Type AON ...	Weight per corrugation approx.	Bellows		
					wall thickness	diameter	
						inside	outside
DN	PN	$2\Delta S_{WN}$	—	$G_w$	s	$D_i$	$D_a$
—	—	mm	—	kg	mm	mm	mm
800	2.5	19	02.0805.	2.5	1	805	915
800	6	12	06.0805.	3.7	1.5	805	912
800	10	9.4	10.0805.	5	2	805	915
800	25	5.2	25.0805.	7	3	805	906
900	4	13	04.0914.	2.4	1	914	1002
900	8	9.2	08.0914.	3.6	1.5	914	1004
900	12.5	7	12.0914.	4.9	2	914	1005
900	25	4.6	25.0914.	7.4	3	914	1007
1000	8	10	08.1016.	4.3	1.5	1016	1110
1000	12.5	8	12.1016.	5.8	2	1016	1113
1000	25	5.4	25.1016.	8.8	3	1016	1115
1100	6	11.2	06.1111.	4.9	1.5	1111	1210
1100	12.5	8	12.1111.	6.4	2	1111	1208
1100	20	5.6	20.1111.	9.8	3	1111	1212
1200	6	11.2	06.1211.	5.3	1.5	1211	1310
1200	10	8.4	10.1211.	7.1	2	1211	1310
1200	20	5.6	20.1211.	10.8	3	1211	1312
1400	8	13.8	08.1412.	10.6	2	1412	1536
1400	12.5	10.8	12.1412.	17.1	3	1412	1548
1600	6	15.6	06.1612.	12.9	2	1612	1746
1600	12.5	12	12.1612.	20.7	3	1612	1758
1800	6	16	06.1812.	14.6	2	1812	1946
1800	12.5	11.8	12.1812.	22.9	3	1812	1955

Bellows					Spring rate axial per corrugation
corrugated length of a corrugation	cuff diameter		maximum number of corrugations	effective cross-section	
	inside	outside			
$l_w$	$D_{B \min.}$	$D_{B \max.}$	$n_w$	A	$C_{0W}$
mm	mm	mm	—	cm <sup>2</sup>	N/mm
29	809	913	8	5809	1300
30	809	909	8	5789	5500
31	809	911	8	5809	12500
33	809	900	9	5748	56000
30	918	1000	10	7208	3100
31	918	1001	10	7223	9800
32	918	1001	10	7231	23500
34	918	1001	10	7246	78000
33	1020	1107	9	8875	9400
34	1020	1109	9	8900	21000
36	1020	1109	9	8917	70000
33	1115	1207	9	10577	9000
35	1115	1204	9	10559	23000
37	1115	1206	9	10596	73000
33	1215	1307	9	12479	9800
36	1215	1306	9	12479	23500
38	1215	1306	9	12499	78000
54	1420	1420	6	17064	13400
56	1420	1420	6	17203	36000
54	1620	1620	6	22141	12400
56	1620	1620	6	22299	33000
54	1820	1820	6	27730	13800
56	1820	1820	6	27863	39000

# SINGLE PLY EXPANSION JOINTS FOR APPARATUS CONSTRUCTION

Type AON



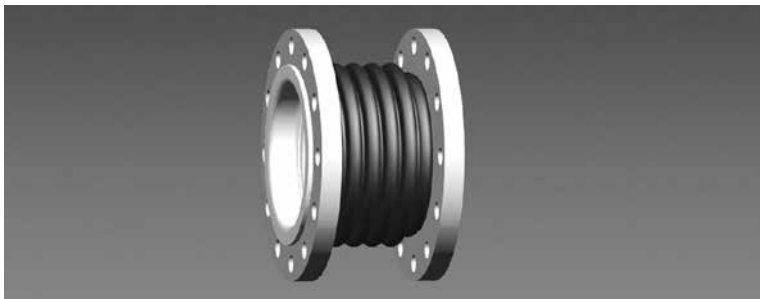
07

Nominal diameter	Nominal pressure	Nominal axial movement absorption per corrugation	Type AON ...	Weight per corrugation approx.	Bellows		
					wall thickness	diameter	
						inside	outside
DN	PN	$2\delta_{WN}$	–	$G_w$	s	$D_i$	$D_a$
–	–	mm	–	kg	mm	mm	mm
2000	6	18	06.2012.	17.2	2	2012	2156
2000	10	13.6	10.2012.	27.4	3	2012	2168
2200	6	18	06.2212.	18.9	2	2212	2356
2200	10	13.4	10.2212.	29.8	3	2212	2366
2400	5	20	05.2412.	22	2	2412	2568
2400	10	14	10.2412.	33.5	3	2412	2572
2600	5	20	05.2612.	24.1	2	2612	2770
2600	8	14	08.2612.	36.3	3	2612	2772
2800	5	20	05.2812.	25.4	2	2812	2966
2800	8	14	08.2812.	39.1	3	2812	2972
3000	5	19.6	05.3012.	26.9	2	3012	3164
3000	8	14	08.3012.	41.9	3	3012	3172

Bellows					Spring rate axial per corrugation
corrugated length of a corrugation	cuff diameter		maximum number of corrugations	effective cross-section	
	inside	outside			
$l_w$	$D_{B \text{ min.}}$	$D_{B \text{ max.}}$	$n_w$	A	$C_{0w}$
mm	mm	mm	–	cm <sup>2</sup>	N/mm
54	2020	2020	6	34110	12300
56	2020	2020	6	34307	34000
54	2220	2220	6	40972	13500
56	2220	2220	6	41151	38800
54	2420	2420	6	48695	12000
56	2420	2420	6	48774	38000
54	2620	2620	6	56874	13400
56	2620	2620	6	56917	40000
54	2820	2820	6	65552	14400
56	2820	2820	6	65688	44000
54	3020	3020	6	74894	16000
56	3020	3020	6	75088	47000

# AXIAL EXPANSION JOINTS WITH PTFE LINING TYPE ABT

07



## Type designation

The type designation consists of 2 parts

1. Type series, defined by 3 letters
2. Nominal size, defined by 9 digits

## Example

Type ABT: HYDRA axial expansion joint with PTFE liner and loose flanges

## Standard design/materials

Multi-ply bellows made of 1.4541

Flange made of S235JRG2 (1.0038) or P250GH (1.0460)

Operating temperature: up to 230 °C

## Type designation (example)

ABT

Type

10

Nominal pressure (PN10)

0150

Nominal diameter (DN150)

060

Movement absorption, nominal  
( $2\delta = \pm 30 = 60$  mm)

## Order text according to guideline 2014/68/EU "Pressure Equipment Directive"

Please state the following with your order:

For standard versions

- Type designation or order number

With material variation

- Type designation
- Details of the materials

According to the Pressure Equipment Directive, the following information is required for testing and documentation:

Type of pressure equipment according to Art. 1 & 2:

- Vessel - volume V [l] \_\_\_\_\_
- Piping - nominal diameter DN \_\_\_\_\_

Medium property according to Art. 13:

- Group 1 – dangerous
- Group 2 – all other fluids

State of medium

- Gaseous or liquid if PD > 0.5 bar
- Liquid if PD ≤ 0.5 bar

Design data:

- Max. allowable pressure [bar] \_\_\_\_\_
- Max./min. allowable temperature [°C] \_\_\_\_\_
- Test pressure PT [bar] \_\_\_\_\_

Optional:

- Category \_\_\_\_\_

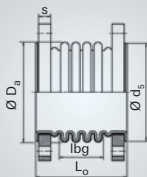
### Note

Tell us the dimensions that deviate from the standard and we customize the expansion joint to your specification.

On request, flanges can also be supplied with other hole patterns / flange sheet thicknesses. In this case, the specified overall length L0 may change.

# AXIAL EXPANSION JOINTS WITH PTFE LINING

Type ABT



Nominal diameter	Nominal axial movement absorption <sup>1)</sup>	Type ABT 10 ...	Order number standard design	Overall length	Weight approx.	Flange <sup>2)</sup>		
						drilling as per EN 1092	flange diameter	thickness
–	$2s_N$	–	–	$L_o$	G	PN	$d_s$	s
–	mm	–	–	mm	kg	-	mm	mm
32	9	.0032.009	427980	147	3.9	40	70	18
32	18	.0032.018	427982	222	4.1	40	70	18
40	11	.0040.011	427985	159	4.5	40	80	18
40	22	.0040.022	427986	244	4.8	40	80	18
50	13	.0050.013	427987	183	6	16	92	20
50	27	.0050.027	427988	298	7	16	92	20
65	17	.0065.017	427989	183	7	16	107	20
65	32	.0065.032	427990	289	8	16	107	20
80	20	.0080.020	427991	188	8	16	122	20
80	35	.0080.035	427992	278	9	16	122	20
100	20	.0100.020	427994	182	10	16	147	22
100	40	.0100.040	427995	270	11	16	147	22
125	29	.0125.029	427996	224	14	16	178	22
125	50	.0125.050	427997	366	17	16	178	22
150	30	.0150.030	427998	251	18	16	208	24
150	60	.0150.060	427999	391	23	16	208	24
200	42	.0200.042	428000	250	25	10	258	24
200	78	.0200.078	428001	422	33	10	258	24
250	44	.0250.044	428002	245	32	10	320	26
250	81	.0250.081	428003	394	38	10	320	26

# TYPE ABT 10... PN 10

07

Bellows			Nominal movement absorption <sup>1)</sup>		Spring rate		
outside diameter	corrugated length	effective cross-section	angular	lateral	axial	angular	lateral
D <sub>s</sub>	l <sub>bg</sub>	A	2α <sub>N</sub>	2λ <sub>N</sub>	c <sub>0</sub>	c <sub>α</sub>	c <sub>λ</sub>
mm	mm	cm <sup>2</sup>	degree	mm	N/mm	Nm/deg	N/mm
61	75	20	20	4.7	471	2.7	327
61	150	20	31	19	235	1.3	40
74	85	30.6	20	5.3	466	4	384
74	170	30.6	30	21	232	1.9	48
88	95	44.7	19	5.7	457	5.7	439
88	209	44.3	32	26	344	4.2	68
106	95	67.1	20	6	352	6.6	507
107	200	67.4	30	24	278	5.3	91
120	100	87.3	20	6.5	312	7.6	525
121	189	87.6	29	22	270	6.6	128
148	88	135	17	4.6	495	18	1671
148	176	135	28	18	247	9.3	208
169	120	179	20	7.9	397	19	956
172	260	181	30	29	409	20	214
204	140	261	18	7.8	743	54	1926
204	280	261	29	31	371	27	240
258	140	432	19	8.5	442	53	1883
261	310	434	30	35	391	48	344
318	120	666	17	6.1	525	98	4696
318	270	667	24	25	341	63	604

1) Inner sleeve, movement absorption: The inner sleeve is designed for axial movement only.

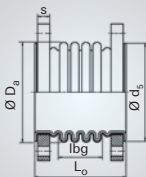
The movements (axial, angular, lateral) apply to 1000 load changes and are to be regarded as alternativ, i.e. the sum of their proportions in percentages should not exceed 100 %.

2) Available with other hole patterns / thicknesses on request. The overall length L0 may change then.



# AXIAL EXPANSION JOINTS WITH PTFE LINING

Type ABT



07

Nominal diameter	Nominal axial movement absorption	Type ABT 10 ...	Order number standard design	Overall length	Weight approx.	Flange <sup>2)</sup>		
						drilling as per EN 1092	flange diameter	thickness
–	$2\delta_N$	–	–	$L_o$	G	PN	$d_s$	s
–	mm	–	–	mm	kg	–	mm	mm
300	55	.0300.055	428004	291	40	10	370	26
300	95	.0300.095	428005	433	51	10	370	26
350	60	.0350.060	428006	304	60	10	410	30
350	92	.0350.092	428007	415	71	10	410	30
400	52	.0400.052	428008	293	74	10	465	32
400	104	.0400.104	428009	437	85	10	465	32
450	70	.0450.070	428010	342	95	10	520	36
450	130	.0450.130	428011	549	127	10	520	36
500	56	.0500.056	428012	323	116	10	570	38
500	126	.0500.126	428013	523	144	10	570	38
600	70	.0600.070	428014	351	147	10	670	42
600	126	.0600.126	428015	499	168	10	670	42

# TYPE ABT 10... PN 10

07

Bellows			Nominal movement absorption <sup>1)</sup>		Spring rate		
outside diameter	corrugated length	effective cross-section	angular	lateral	axial	angular	lateral
D <sub>s</sub>	l <sub>bg</sub>	A	2c <sub>αN</sub>	2λ <sub>Nl</sub>	c <sub>0</sub>	c <sub>α</sub>	c <sub>λ</sub>
mm	mm	cm <sup>2</sup>	degree	mm	N/mm	Nm/deg	N/mm
374	165	932	17	8.9	522	136	3447
375	306	932	25	28	405	106	780
408	170	1119	17	9.1	501	157	3741
409	280	1119	23	23	436	137	1203
463	144	1449	13	5.9	767	312	10331
463	288	1449	22	23	383	156	1290
516	185	1821	15	9	600	306	6154
516	390	1813	24	35	531	271	1225
571	160	2235	12	5.6	1172	735	19775
571	360	2235	22	29	521	327	1736
678	185	3201	12	6.8	824	737	14818
678	333	3201	17	22	457	409	2538

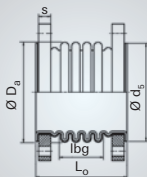
1) Inner sleeve, movement absorption: The inner sleeve is designed for axial movement only.

The movements (axial, angular, lateral) apply to 1000 load changes and are to be regarded as alternativ, i.e. the sum of their

2) Available with other hole patterns / thicknesses on request. The overall length L0 may change then.

# AXIAL EXPANSION JOINTS WITH PTFE LINING

Type ABT



07

Nominal diameter	Nominal axial movement absorption	Type ABT 25 ...	Order number standard design	Overall length	Weight approx.	Flange <sup>2)</sup>		
						drilling as per EN 1092	flange diameter	thickness
–	$2s_N$	–	–	$L_o$	G	PN	$d_s$	s
–	mm	–	–	mm	kg	–	mm	mm
32	8	.0032.008	428016	148	4	40	70	18
32	15	.0032.015	428017	208	4.2	40	70	18
40	10	.0040.010	428018	165	4.6	40	80	18
40	17	.0040.017	428019	265	5	40	80	18
50	15	.0050.015	428021	203	6	40	92	20
50	24	.0050.024	428022	310	7	40	92	20
65	14	.0065.014	428023	199	8	40	107	22
65	26	.0065.026	428024	183	9	40	107	22
80	16	.0080.016	428027	214	10	40	122	24
80	29	.0080.029	428029	306	11	40	122	24
100	21	.0100.021	428030	224	14	40	147	26
100	35	.0100.035	428032	330	17	40	147	26
125	20	.0125.020	428033	222	20	40	178	28
125	35	.0125.035	428034	300	22	40	178	28
150	26	.0150.026	428035	263	24	40	208	30
150	47	.0150.047	428036	375	30	40	208	30
200	30	.0200.030	428037	243	36	25	258	32
200	52	.0200.052	428038	330	40	25	258	32
250	35	.0250.035	428039	272	51	25	320	35
250	61	.0250.061	428040	368	57	25	320	35

# TYPE ABT 25... PN 25

**07**

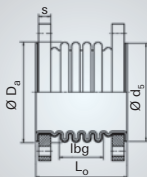
Bellows			Nominal movement absorption <sup>1)</sup>		Spring rate		
outside diameter	corrugated length	effective cross-section	angular	lateral	axial	angular	lateral
D <sub>s</sub>	l <sub>bg</sub>	A	2α <sub>N</sub>	2λ <sub>N</sub>	c <sub>0</sub>	c <sub>α</sub>	c <sub>λ</sub>
mm	mm	cm <sup>2</sup>	degree	mm	N/mm	Nm/deg	N/mm
61	75	19.7	17	4.2	794	4.5	551
61	135	19.7	24	14	440	2.4	94
75	90	30.8	17	5	776	6.8	579
75	190	30.5	22	18	678	5.9	113
88	114	44.3	19	7.9	630	7.9	419
89	220	44.2	25	24	708	9.1	128
108	105	67.2	16	5.4	1075	20	1292
108	189	67.2	23	18	596	11.4	221
123	115	87.8	16	5.9	1192	29	1562
123	207	87.8	23	19	663	16	267
150	120	135.2	16	6.5	891	33	1643
151	225	135	23	20	759	29	400
172	104	181	14	4.7	1025	53	3351
172	182	181	20	14	586	29	625
204	140	260	15	6.8	1443	106	3738
204	252	260	21	22	802	59	640
261	116	436	13	5	1186	145	7463
261	203	436	19	15	677	83	1391
322	128	672	13	5.1	1244	236	9912
322	224	672	18	16	711	135	1849

1) Inner sleeve, movement absorption: The inner sleeve is designed for axial movement only. The movements (axial, angular, lateral) apply to 1000 load changes and are to be regarded as alternativ, i.e. the sum of their proportions in percentages should not exceed 100 %.

2) Available with other hole patterns / thicknesses on request. The overall length L0 may change then.

# AXIAL EXPANSION JOINTS WITH PTFE LINING

Type ABT



07

Nominal diameter	Nominal axial movement absorption	Type ABT 25 ...	Order number standard design	Overall length	Weight approx.	Flange <sup>2)</sup>		
						drilling as per EN 1092	flange diameter	thickness
–	$2\delta_{N_1}$	–	–	$L_o$	G	PN	$d_s$	s
–	mm	–	–	mm	kg	-	mm	mm
300	40	.0300.040	428041	297	71	25	375	38
300	70	.0300.070	428042	405	80	25	375	38
350	42	.0350.042	428043	309	103	25	410	42
350	73	.0350.073	428044	420	112	25	410	42
400	44	.0400.044	428045	345	146	25	465	48
400	88	.0400.088	428046	505	166	25	465	48
450	50	.0450.050	428047	402	190	25	520	54
450	90	.0450.090	428048	566	219	25	520	54
500	48	.0500.048	428049	373	228	25	570	58
500	96	.0500.096	428050	541	264	25	570	58
600	48	.0600.048	428051	386	325	25	670	68
600	96	.0600.096	428052	550	369	25	670	68

# TYPE ABT 25...

## PN 25

07

Bellows			Nominal movement absorption <sup>1)</sup>		Spring rate		
outside diameter	corrugated length	effective cross-section	angular	lateral	axial	angular	lateral
D <sub>s</sub>	l <sub>bg</sub>	A	2c <sub>αN</sub>	2λ <sub>Nl</sub>	c <sub>0</sub>	c <sub>α</sub>	c <sub>λ</sub>
mm	mm	cm <sup>2</sup>	degree	mm	N/mm	Nm/deg	N/mm
377	144	932	12	5.6	1470	387	12844
377	252	932	18	17	839	221	2395
410	148	1116	12	5.5	1489	469	14731
410	259	1116	17	17	851	267	2749
464	160	1439	11	5.5	2068	842	22617
464	320	1439	18	22	1033	421	2824
523	205	1831	11	7.1	1953	1011	16539
523	369	1831	16	23	1085	561	2836
578	168	2255	9.6	5	2211	1406	34269
578	336	2255	16	20	1105	703	4280
680	164	3190	8.1	4.1	2329	2091	53466
680	328	3190	13	16	1164	1045	6683

1) Inner sleeve, movement absorption: The inner sleeve is designed for axial movement only.

The movements (axial, angular, lateral) apply to 1000 load changes and are to be regarded as alternativ, i.e. the sum of their proportions in percentages should not exceed 100 %.

2) Available with other hole patterns / thicknesses on request. The overall length L0 may change then.

# AXIAL EXPANSION JOINTS WITH PRETENSION TYPE ARH

07



## Type designation

The type designation consists of 2 parts

1. Type series, defined by 3 letters
2. Nominal size, defined by 10 digits

## Example

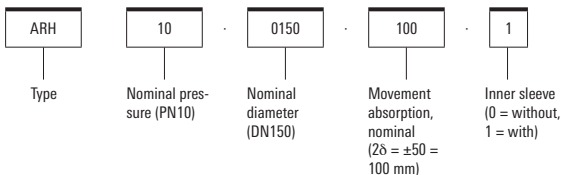
Type ARH: HYDRA axial expansion joints with pretension

## Standard design/materials

Multi-ply bellows made of 1.4541

Operating temperature: up to 300 °C

## Type designation (example)



## Order text according to guideline 2014/68/EU "Pressure Equipment Directive"

Please state the following with your order:

For standard versions

- Type designation or order number

With material variation

- Type designation
- Details of the materials

According to the Pressure Equipment Directive, the following information is required for testing and documentation:

Type of pressure equipment according to Art. 1 & 2:

- Vessel - volume V [l] \_\_\_\_\_
- Piping - nominal diameter DN \_\_\_\_\_

Medium property according to Art. 13:

- Group 1 – dangerous
- Group 2 – all other fluids

State of medium

- Gaseous or liquid if PD > 0.5 bar
- Liquid if PD ≤ 0.5 bar

Design data:

- Max. allowable pressure [bar] \_\_\_\_\_
- Max./min. allowable temperature [°C] \_\_\_\_\_
- Test pressure PT [bar] \_\_\_\_\_

Optional:

- Category \_\_\_\_\_

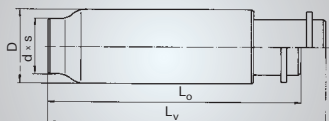
### Note

Tell us the dimensions that deviate from the standard and we customize the expansion joint to your specification.



# AXIAL EXPANSION JOINTS WITH PRETENSION

Type ARH



07

Nominal diameter	Nominal axial movement absorption	Type ARH 16...	Overall length		Weight approx.
			unloaded	pre-tensioned	
–	$2\delta_N$	–	$L_o$	$L_v$	G
–	mm	–	mm	mm	kg
50	34	.0050.034.0	290	307	3
50	66	.0050.066.0	450	483	4
50	100	.0050.100.0	620	670	6
65	40	.0065.040.0	290	310	5
65	80	.0065.080.0	450	490	7
65	120	.0065.120.0	650	710	10
80	80	.0080.080.0	500	540	8
80	120	.0080.120.0	630	690	10
80	160	.0080.160.0	850	930	14
100	90	.0100.090.0	555	600	11
100	140	.0100.140.0	700	770	15
100	180	.0100.180.0	960	1050	21
125	100	.0125.100.0	550	600	15
125	150	.0125.150.0	700	775	20
125	200	.0125.200.0	950	1050	29
150	100	.0150.100.0	550	600	20
150	150	.0150.150.0	700	775	27
150	200	.0150.200.0	950	1050	37
200	100	.0200.100.0	580	630	30
200	150	.0200.150.0	750	825	42
200	200	.0200.200.0	950	1050	57
250	100	.0250.100.0	580	630	42
250	150	.0250.150.0	750	825	57
250	200	.0250.200.0	950	1050	82

# TYPE ARH 16...

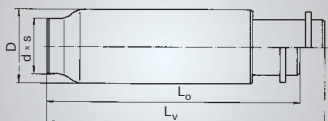
## PN 16

07

Weld ends		External pipe diameter	Effective bellows cross-section	Axial spring rate	Shear force	Perm. torsional movement
outside diameter	wall thickness					
d	s	D	A	c <sub>s</sub>	F <sub>s</sub>	Mt
mm	mm	mm	cm <sup>2</sup>	N/mm	kN	kNm
60.3	2.9	106	45	60	5	0.3
60.3	2.9	106	45	30	5	0.3
60.3	2.9	106	45	45	5	0.3
76.1	2.9	120	68	60	8	0.4
76.1	2.9	120	68	30	8	0.4
76.1	2.9	120	68	45	8	0.4
88.9	3.2	135	88	115	11	0.8
88.9	3.2	135	88	40	11	0.8
88.9	3.2	135	88	60	11	0.8
114.3	3.6	161	135	120	11	1.1
114.3	3.6	161	135	40	11	1.1
114.3	3.6	161	135	60	11	1.1
139.7	3.6	196	201	120	19	2
139.7	3.6	196	201	45	19	2
139.7	3.6	196	201	60	19	2
168.3	4.0	224	279	120	19	2.4
168.3	4.0	224	279	50	19	2.4
168.3	4.0	224	279	60	19	2.4
219.1	4.5	287	448	110	27	4.1
219.1	4.5	287	448	60	27	4.1
219.1	4.5	287	448	55	27	4.1
273.0	5.0	344	684	120	40	7.0
273.0	5.0	344	684	75	40	7.0
273.0	5.0	344	684	60	40	7.0

# AXIAL EXPANSION JOINTS WITH PRETENSION

Type ARH



07

Nominal diameter	Nominal axial movement absorption	Type ARH 16...	Overall length		Weight approx. G kg
			unloaded $L_o$ mm	pre-tensioned $L_v$ mm	
–	$2\delta_N$	–	$L_o$	$L_v$	G
–	mm	–	mm	mm	kg
300	100	.0300.100.0	580	630	56
300	150	.0300.150.0	800	875	77
300	200	.0300.200.0	950	1050	105
350	100	.0350.100.0	580	630	70
350	150	.0350.150.0	800	875	95
350	200	.0350.200.0	950	1050	130
400	100	.0400.100.0	580	630	85
400	150	.0400.150.0	800	875	110
400	200	.0400.200.0	1000	1100	160
450	100	.0450.100.0	650	700	100
450	150	.0450.150.0	800	875	140
450	200	.0450.200.0	1000	1100	190
500	100	.0500.100.0	650	700	120
500	150	.0500.150.0	800	875	160
500	200	.0500.200.0	1000	1100	220
600	100	.0600.100.0	650	700	150
600	150	.0600.150.0	825	900	210
600	200	.0600.200.0	1000	1150	280

# TYPE ARH 16...

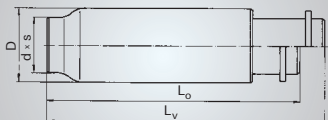
## PN 16

07

Weld ends		External pipe diameter	Effective bellows cross-section	Axial spring rate	Shear force	Perm. torsional movement
outside diameter	wall thickness					
d	s	D	A	c <sub>s</sub>	F <sub>s</sub>	Mt
mm	mm	mm	cm <sup>2</sup>	N/mm	kN	kNm
323.9	5.6	405	958	120	40	8.2
323.9	5.6	405	958	80	40	8.2
323.9	5.6	405	958	60	40	8.2
355.6	5.6	437	1115	120	40	9.0
355.6	5.6	437	1115	230	40	9.0
355.6	5.6	437	1115	60	40	9.0
406.4	6.3	487	1442	240	65	18.0
406.4	6.3	487	1442	250	65	18.0
406.4	6.3	487	1442	120	65	18.0
457.2	6.3	545	1821	300	71	23.0
457.2	6.3	545	1821	270	71	23.0
457.2	6.3	545	1821	150	71	23.0
508.0	6.3	610	2240	360	73	25.0
508.0	6.3	610	2240	240	73	25.0
508.0	6.3	610	2240	180	73	25.0
609.6	6.3	711	3197	560	94	39.0
609.6	6.3	711	3197	370	94	39.0
609.6	6.3	711	3197	280	94	39.0

# AXIAL EXPANSION JOINTS WITH PRETENSION

Type ARH



07

Nominal diameter	Nominal axial movement absorption	Type ARH 16...	Overall length		Weight approx.
			unloaded	pre-tensioned	
–	$2\delta_N$	–	$L_o$	$L_v$	G
–	mm	–	mm	mm	kg
700	100	.0700.100.0	650	700	190
700	150	.0700.150.0	875	950	260
700	200	.0700.200.0	1050	1150	350
800	100	.0800.100.0	700	750	240
800	150	.0800.150.0	875	950	320
800	200	.0800.200.0	1050	1150	430
900	100	.0900.100.0	700	750	300
900	150	.0900.150.0	900	975	400
900	200	.0900.200.0	1050	1150	530
1000	100	.1000.100.0	700	750	370
1000	150	.1000.150.0	900	975	500
1000	200	.1000.200.0	1050	1150	660

# TYPE ARH 16...

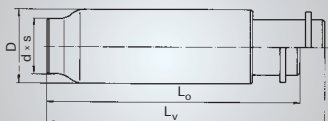
## PN 16

07

Weld ends		External pipe diameter	Effective bellows cross-section	Axial spring rate	Shear force	Perm. torsional movement
outside diameter	wall thickness					
d	s	D	A	c <sub>s</sub>	F <sub>s</sub>	Mt
mm	mm	mm	cm <sup>2</sup>	N/mm	kN	kNm
711.0	7.1	820	4318	540	98	46.0
711.0	7.1	820	4318	300	98	46.0
711.0	7.1	820	4318	245	98	46.0
813.0	8.0	930	5615	600	133	69.0
813.0	8.0	930	5615	380	133	69.0
813.0	8.0	930	5615	300	133	69.0
914.0	10.0	1050	7173	870	126	78.0
914.0	10.0	1050	7173	440	126	78.0
914.0	10.0	1050	7173	350	126	78.0
1016.0	10.0	1160	8834	860	124	86.0
1016.0	10.0	1160	8834	490	124	86.0
1016.0	10.0	1160	8834	380	124	86.0

# AXIAL EXPANSION JOINTS WITH PRETENSION

Type ARH



07

Nominal diameter	Nominal axial movement absorption	Type ARH 25...	Overall length		Weight approx.
			unloaded	pre-tensioned	
–	$2\delta_N$	–	$L_0$	$L_V$	G
–	mm	–	mm	mm	kg
50	34	.0050.034.1	300	317	4
50	66	.0050.066.1	450	483	5
50	100	.0050.100.1	640	690	7
65	40	.0065.040.1	300	320	6
65	80	.0065.080.1	450	490	8
65	120	.0065.120.1	664	725	11
80	70	.0080.070.1	480	515	9
80	110	.0080.110.1	610	665	12
80	140	.0080.140.1	810	880	17
100	80	.0100.080.1	560	600	13
100	120	.0100.120.1	720	780	18
100	160	.0100.160.1	970	1050	24
125	84	.0125.084.1	558	600	18
125	130	.0125.130.1	735	800	24
125	170	.0125.170.1	965	1050	34
150	90	.0150.090.1	555	600	24
150	140	.0150.140.1	760	830	32
150	180	.0150.180.1	960	1050	45

# TYPE ARH 25...

## PN 25

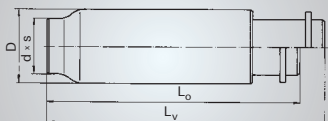
07

Weld ends		External pipe diameter	Effective bellows cross-section	Axial spring rate	Shear force	Perm. torsional movement
outside diameter	wall thickness					
d	s	D	A	c <sub>s</sub>	F <sub>s</sub>	Mt
mm	mm	mm	cm <sup>2</sup>	N/mm	kN	kNm
60.3	2.9	106	45	80	5	0.2
60.3	2.9	106	45	40	5	0.2
60.3	2.9	106	45	70	5	0.2
76.1	2.9	120	68	90	6	0.4
76.1	2.9	120	68	45	6	0.4
76.1	2.9	120	68	65	6	0.4
88.9	3.2	135	88	160	10	0.8
88.9	3.2	135	88	65	10	0.8
88.9	3.2	135	88	80	10	0.8
114.3	3.6	161	135	200	10	0.9
114.3	3.6	161	135	70	10	0.9
114.3	3.6	161	135	100	10	0.9
139.7	3.6	196	201	200	17	1.9
139.7	3.6	196	201	80	17	1.9
139.7	3.6	196	201	100	17	1.9
168.3	4.0	224	279	200	17	2.1
168.3	4.0	224	279	90	17	2.1
168.3	4.0	224	279	100	17	2.1



# AXIAL EXPANSION JOINTS WITH PRETENSION

Type ARH



07

Nominal diameter	Nominal axial movement absorption	Type ARH 25...	Overall length		Weight approx.
			unloaded	pre-tensioned	
–	$2\delta_N$	–	$L_0$	$L_v$	G
–	mm	–	mm	mm	kg
200	100	.0200.100.1	600	650	36
200	150	.0200.150.1	785	860	50
200	200	.0200.200.1	1000	1100	70
250	100	.0250.100.1	600	650	50
250	150	.0250.150.1	785	860	70
250	200	.0250.200.1	1000	1100	95
300	100	.0300.100.1	600	650	70
300	150	.0300.150.1	800	875	90
300	200	.0300.200.1	1000	1100	95
350	100	.0350.100.1	600	650	80
350	150	.0350.150.1	800	875	110
350	200	.0350.200.1	1000	1100	150
400	100	.0400.100.1	600	650	100
400	150	.0400.150.1	800	875	130
400	200	.0400.200.1	1000	1100	190
450	100	.0450.100.1	650	700	120
450	150	.0450.150.1	825	900	160
450	200	.0450.200.1	1050	1150	220

# TYPE ARH 25...

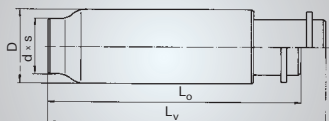
## PN 25

**07**

Weld ends		External pipe diameter	Effective bellows cross-section	Axial spring rate	Shear force	Perm. torsional movement
outside diameter	wall thickness					
d	s	D	A	c <sub>s</sub>	F <sub>s</sub>	Mt
mm	mm	mm	cm <sup>2</sup>	N/mm	kN	kNm
219.1	4.5	287	448	200	36	5.6
219.1	4.5	287	448	100	36	5.6
219.1	4.5	287	448	100	36	5.6
273.0	5.0	344	684	200	36	6.9
273.0	5.0	344	684	110	36	6.9
273.0	5.0	344	684	100	36	6.9
323.9	5.6	405	958	220	70	15.0
323.9	5.6	405	958	120	70	15.0
323.9	5.6	405	958	110	70	15.0
355.6	6.3	437	1115	200	70	16.0
355.6	6.3	437	1115	160	70	16.0
355.6	6.3	437	1115	100	70	16.0
406.4	7.1	487	1442	300	70	18.0
406.4	7.1	487	1442	280	70	18.0
406.4	7.1	487	1442	150	70	18.0
457.2	8.0	545	1821	460	99	30.0
457.2	8.0	545	1821	320	99	30.0
457.2	8.0	545	1821	230	99	30.0

# AXIAL EXPANSION JOINTS WITH PRETENSION

Type ARH



07

Nominal diameter	Nominal axial movement absorption	Type ARH 25...	Overall length		Weight approx. G kg
			unloaded $L_o$ mm	pre-tensioned $L_v$ mm	
–	$2\delta_N$	–	$L_o$	$L_v$	G
–	mm	–	mm	mm	kg
500	100	.0500.100.1	650	700	140
500	150	.0500.150.1	825	900	190
500	200	.0500.200.1	1050	1150	260
600	100	.0600.100.1	650	700	180
600	150	.0600.150.1	825	900	240
600	200	.0600.200.1	1050	1150	340
700	100	.0700.100.1	700	700	220
700	150	.0700.150.1	925	1000	300
700	200	.0700.200.1	1050	1150	420
800	100	.0800.100.1	700	750	270
800	150	.0800.150.1	925	1000	370
800	200	.0800.200.1	1100	1200	520
900	100	.0900.100.1	700	750	330
900	150	.0900.150.1	925	1000	460
900	200	.0900.200.1	1100	1200	650
1000	100	.1000.100.1	700	750	410
1000	150	.1000.150.1	925	1000	570
1000	200	.1000.200.1	1100	1200	810

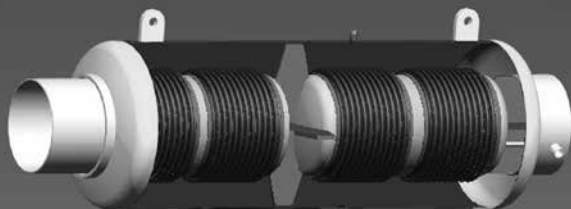
# TYPE ARH 25...

## PN 25

07

Weld ends		External pipe diameter	Effective bellows cross-section	Axial spring rate	Shear force	Perm. torsional movement
outside diameter	wall thickness					
d	s	D	A	c <sub>s</sub>	F <sub>s</sub>	Mt
mm	mm	mm	cm <sup>2</sup>	N/mm	kN	kNm
508.0	8.0	610	2240	610	131	33.0
508.0	8.0	610	2240	410	131	33.0
508.0	8.0	610	2240	305	131	33.0
609.6	10.0	711	3197	630	131	52.0
609.6	10.0	711	3197	500	131	52.0
609.6	10.0	711	3197	315	131	52.0
711.0	11.0	820	4318	1230	198	95.0
711.0	11.0	820	4318	770	198	95.0
711.0	11.0	820	4318	560	198	95.0
813.0	12.5	930	5615	1160	198	108.0
813.0	12.5	930	5615	725	198	108.0
813.0	12.5	930	5615	580	198	108.0
914.0	14.2	1050	7173	1750	183	119.0
914.0	14.2	1050	7173	875	183	119.0
914.0	14.2	1050	7173	700	183	119.0
1016.0	14.2	1160	8834	1580	183	132.0
1016.0	14.2	1160	8834	900	183	132.0
1016.0	14.2	1160	8834	700	183	132.0

# PRESSURE BALANCED AXIAL EXPANSION JOINTS TYPE DRD



07

## Type designation

The type designation consists of 2 parts

1. Type series, defined by 3 letters
2. Nominal size, defined by 10 digits

## Example

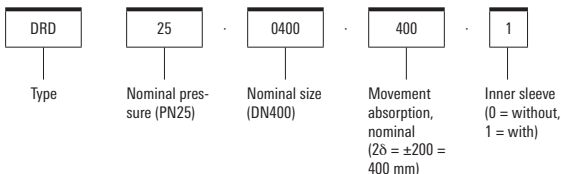
Type DRD: HYDRA pressure balanced axial expansion joint

## Standard design/materials

Multi-ply bellows made of 1.4541

Operating temperature: up to 300 °C

## Type designation (example)



## Order text according to guideline 2014/68/EU "Pressure Equipment Directive"

Please state the following with your order:

For standard versions

- Type designation or order number

With material variation

- Type designation
- Details of the materials

According to the Pressure Equipment Directive, the following information is required for testing and documentation:

Type of pressure equipment according to Art. 1 & 2:

- Vessel - volume V [l] \_\_\_\_\_
- Piping - nominal diameter DN \_\_\_\_\_

Medium property according to Art. 13:

- Group 1 – dangerous
- Group 2 – all other fluids

State of medium

- Gaseous or liquid if PD > 0.5 bar
- Liquid if PD ≤ 0.5 bar

Design data:

- Max. allowable pressure [bar] \_\_\_\_\_
- Max./min. allowable temperature [°C] \_\_\_\_\_
- Test pressure PT [bar] \_\_\_\_\_

Optional:

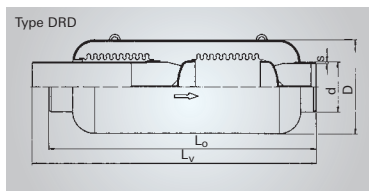
- Category \_\_\_\_\_

### Note

Tell us the dimensions that deviate from the standard and we customize the expansion joint to your specification.

# PRESSURE BALANCED AXIAL EXPANSION JOINTS

# TYPE DRD 25... PN 25

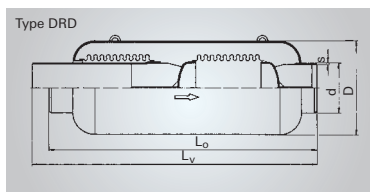


07

Nominal diameter	Nominal axial movement absorption	Type DRD 25...	Overall length		Weight approx.	Weld ends		Casing outside diameter	Axial spring rate
			unloaded	pre-tensioned		outside diameter	wall thickness		
–	$2\delta_H$	–	$L_0$	$L_V$	G	d	s	D	$c_0$
–	mm	–	mm	mm	kg	mm	mm	mm	N/mm
400	360	.. 0400.360.1	2800	2980	720	406.4	7.1	650	249
500	360	.. 0500.360.1	2900	3080	1000	508	8	813	341
600	380	.. 0600.380.1	3100	3290	1380	610	10	950	448
700	360	.. 0700.360.1	3350	3530	2000	711	10	1150	552
800	300	.. 0800.300.1	3350	3500	2250	813	10	1250	796
900	300	.. 0900.300.1	3350	3500	3200	914	12	1500	932
1000	300	.. 1000.300.1	3500	3650	3750	1016	12	1600	1173

# PRESSURE BALANCED AXIAL EXPANSION JOINTS

# TYPE DRD 40... PN 40



Nominal diameter	Nominal axial movement absorption	Type DRD 40...	Overall length		Weight approx.	Weld ends		Casing outside diameter	Axial spring rate
			un-stressed	pre-stressed		outside diameter	wall thickness		
–	2δN	–	L <sub>0</sub>	L <sub>v</sub>	G	d	s	D	c <sub>δ</sub>
–	mm	–	mm	mm	kg	mm	mm	mm	N/mm
400	300	.. 0400.300.1	3000	3150	1000	406.4	8	711	411
500	240	.. 0500.240.1	2850	2970	1400	508	10	813	756
600	240	.. 0600.240.1	2900	3020	2050	610	12	950	980
700	240	.. 0700.240.1	3350	3470	3100	711	12	1150	1107
800	240	.. 0800.240.1	3400	3520	3650	813	15	1250	1401
900	220	.. 0900.220.1	3450	3560	5250	914	15	1500	1744
1000	220	.. 1000.220.1	3500	3610	6350	1016	20	1600	2250

07



# RECTANGULAR EXPANSION JOINTS

## TYPE XOZ, XFZ, XRZ, XSZ

### Design and choice of expansion joints

The necessary number of corrugations  $n_w$  is dependent on the movement

### Number of corrugations $n_w$

$$(7.5) \quad n_w = 2\delta_{RT} / 2\delta_{WN}$$

Axial movement absorption, cold  $2\delta_{RT}$  in mm

Axial movement absorption per corrugation  $2\delta_{WN}$  in mm

Nominal movement, corrugated length and spring rate of the multi-corrugation expansion joint are dependent on the selected number of corrugations (rounded up to an integer number):

### Corrugated length in mm

$$(7.6) \quad l = l_w \cdot n_w$$

Length of individual corrugations  $l_w$  in mm

Number of corrugations  $n_w$

The length of the cuffs or the connection parts must be taken into account when determining the total length  $L_o$  of the complete expansion joint.

### Axial spring rate of one corrugation $c_{\delta w}$ in N/mm

$$(7.7) \quad c_{\delta w} = c_{\delta E} / n_w + 2(b_1 + b_2)c_{\delta l}$$

Spring rate of four corners,  $c_{\delta E}$  in N/mm

Spring rate for 1 mm profile length,  $c_{\delta l}$  in N/mm

Length of sides  $b_1$ ,  $b_2$  in mm

## Spring rate of complete expansion joint $c_{\delta}$ in N/mm

$$(7.8) \quad c_{\delta} = c_{\delta W} / n_W$$

Connection parts	Type series
None	XOZ
Flange	XFZ
Weld ends	XRZ
others	XSZ

Fig. 7.9 Connection parts / Type series

07

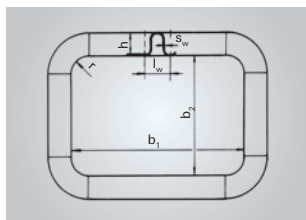


Fig. 7.10 Type XOZ

Please consult us for further details.

# AXIAL EXPANSION JOINTS FOR VACUUM TECHNOLOGY

Expansion joints for vacuum systems are usually designed using single-ply bellows with relatively thin walls. Their small adjusting forces and moments place only a very slight load on the connection flanges, which is essential to ensure absolute tightness of the flange connections during operation. The bellows can be welded to the connection flanges gap-free and vacuum-tight due to the use of special flanged weld seams.

High and highest leak tightness levels can be verified by means of He.-leak tightness tests. The minimum leakage rate which can be determined is  $10^{-10}$  mbar·l·s<sup>-1</sup>.

Flanges are used predominantly for the connections:

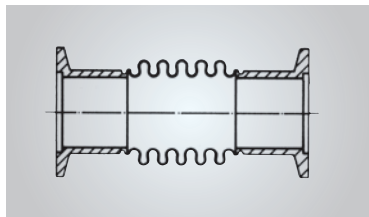
## **DN 16-50**

Small flanges according to DIN 28 403

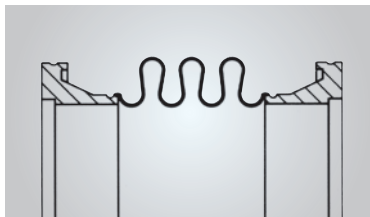
## **DN 63-500**

Clamp flanges according to DIN 28 404

The vacuum expansion joints can be designed on request with total lengths and movement adapted to specific applications.



*Fig. 7.11 Axial expansion joint with small flanges*



*Fig. 7.12 Axial expansion joint with clamping flanges*

# AXIAL EXPANSION JOINTS FOR HEATING AND VENTILATION INSTALLATIONS

We have developed a series of axial expansion joints especially for the needs of heating and sanitary construction, whose different types of connection are adapted to specific assembly conditions:

- Weld ends
- Loose or fixed flanges, drilled according to DIN
- Screwed nipples with pipe thread, male or female

The connection parts are made of carbon steel as standard, whilst the corrugated metal bellows are made of stainless steel 1.4541. These provide excellent corrosion resistance for reliable operation extending over several decades. The expansion joints are designed accordingly for 10000 full load cycles (in contrast with the standard range), as necessary in heating and ventilation installations owing to the more frequent temperature changes.

Guiding sleeves are provided in some designs; they simplify aligned installation, although they cannot replace slide points or anchors. Designs with an external protection cover are pretensioned in the factory. This means that assembly errors are largely eliminated and the installation of thermal insulation is simplified.

**Nominal diameters: DN 15-100**

**Nominal pressures: PN 6-25**

Exact dimensions and performance data are specified in a separate publication "Metal hoses and expansion joints for technical building equipment".



Fig. 7.13 Expansion joints for heating and ventilating installations

## EXPANSION JOINTS AND METAL BELLOWS FOR HIGH PRESSURES

Our standard ranges include expansion joints with nominal pressure ratings which are fully sufficient under normal circumstances for piping and plant construction. If a higher nominal pressure is necessary in individual cases, for example in heat exchangers, individually designed expansion joints can also be supplied. If the combined requirements of inner pressure and movement cause the technical limits to be reached, it is sometimes possible to use reinforcing rings or to apply pressure to the bellows externally (see also Chapter 8, "Special designs"). In addition, metal bellows, such as those used for stem sealing in valves, must often be designed for high pressures, which are mostly applied externally.

07



*Fig. 7.14 High-pressure bellows*

## Delivery options

The graph below provides an overview of the delivery options with regard to multi-ply high-pressure bellows with lyre-shaped corrugations. It shows the external pressure load which can be achieved when the pressure is applied externally. Additional tools are necessary for some nominal diameters in the shaded area.

If the pressure is applied internally, the pressure values achieved are almost identical if low movement values demand only a few number of corrugations. If larger movements are required, the permissible pressure is reduced for reasons of stability.

Please consult us for further details.

07

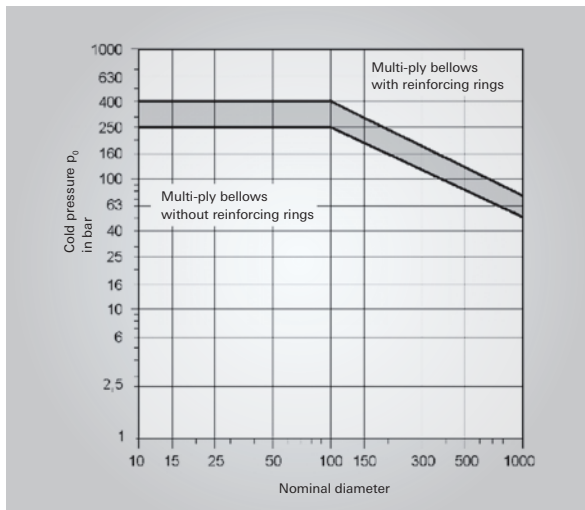


Fig. 7.15 Maximum pressure of multi-ply bellows made of 1.4541 (lyre-shaped corrugations)

## THIN-WALLED PIPES

Thin-walled pipes with a longitudinal weld seam are available in any diameters. The diameters have close tolerances.

If desired, we can provide cylinders with end cuffs, beads or corrugations, or further process them to produce vessels.



Fig. 7.16 Thin-walled pipes, with longitudinal weld seam

### Delivery options

The table below specifies the length which can be supplied for 1.4541 and 1.4571 that also apply to materials with similar strength values.

The supplied lengths may have to be reduced for materials whose strength values are very different from those specified here.

Special materials can also be used instead of austenitic stainless steels like 1.4541 and 1.4571. Almost all the stainless steels and special alloys listed in Chapter 17 are available.

Stainless steel pipes with fixed diameters are available in longer sizes (up to approx. 6 m) in the diameter range DN 5 – 150.

Please consult us if you require further details.

## Available lengths

Diameter Range	Length, dependent on wall thickness, in mm valid for stainless steel 1.4541 and 1.4571			
	Standard wall thickness $s_n$ in mm			
	0.3	0.5	0.7	1.0
$d_i$	–	–	–	–
mm	–	–	–	–
40 - 60	600	400	250	200
61 - 80	800	800	600	400
81 - 90	1200	800	600	400
91 - 110	1200	1200	800	800
111 - 150	1200	1200	1200	800
151 - 1000	1200	1200	1200	1200

Fig. 7.17



# CUSTOM-BUILT DESIGNS



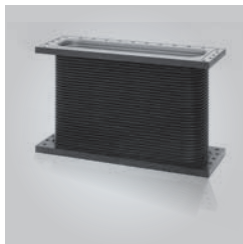
08

## Expansion joints made of special materials

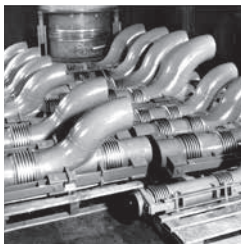
Aggressive media, extremely low weight, electrical conductivity and magnetic permeability are possible reasons for using either expansion joint bellows or complete expansion joints made of special materials, such as:

- Copper
- Aluminium
- Titanium

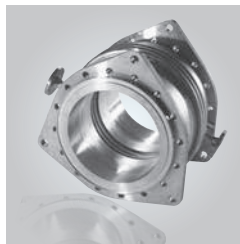
Outstanding knowledge and experience in the field of welding and forming techniques are necessary to manufacture them.



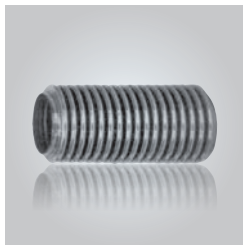
*Fig. 8.1 Exp. joint as hollow conductor made of aluminium*



*Fig. 8.2 Pressure balanced expansion joint*



*Fig. 8.3 Chamber expansion joint made of titanium for the chemical industry*



*Fig. 8.4 Metal bellows made of copper*



*Fig. 8.5 Axial expansion joint with aluminium flanges for absorbing vibrations*



*Fig. 8.6 Axial expansion joint made of Alloy 825 for heat exchanger (DN 1200/PN 40)*

## Axial expansion joints for chemical tankers

Special expansion joints for product and chemical tankers combine the high flexibility and pressure resistance of multi-ply expansion joints with the excellent resistance to chemicals and seawater provided by an internal PTFE liner. Its other main characteristic: it can be flushed, even if the pipeline is routed horizontally!

This special axial expansion joint has a multi-ply, stainless steel bellows with a special corrugation shape, to which support elements for the internal liner can be fitted. The internal liner is made of polytetrafluoroethylene (PTFE) and is resistant to the chemicals that have to be transported. Its shallowly corrugated shape and its smooth surface prevent the conveyed products from sticking and permit the pipe to be cleaned by flushing. There are no residue chemicals, even if the expansion joint is installed horizontally. The liner is bent around the flanges with a special corrosion-proof coating, and also acts as a seal. The outer ply of the bellows is made of Alloy 825. It is corrosion-proof, resistant to seawater and allows the expansion joint to be used on deck.

08

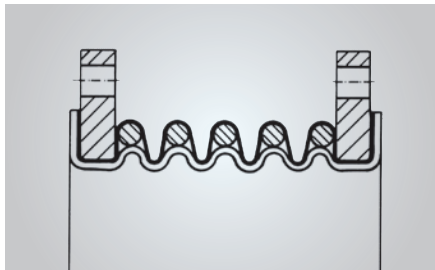


Fig. 8.7 Axial expansion joint for chemical tankers

## Axial expansion joints, pressure applied externally

The bellows of this design is arranged so that the pressure is applied externally to it. This makes the design more complex, since bellows with a larger diameter and an additional, pressure resistant outer casing are necessary, but on the other hand offers a number of potential, crucial advantages:

- Extremely large movement absorption in conjunction with low adjusting forces, since stability problems which would have to be taken into account if the pressure was applied internally are practically insignificant
- The bellows are protected from damage by the outer casing
- No residues of aggressive liquids or condensates remain in the corrugations, since they can drain off
- No deposits of solids can remain in the corrugations, since the corrugations are not located in the line of flow
- The expansion joint and the downstream pipe can be completely drained and vented. (Note: Normally it is not necessary to drain the bellows corrugations of HYDRA expansion joints with small corrugations, since only a small volume of liquid can remain in the corrugations.)

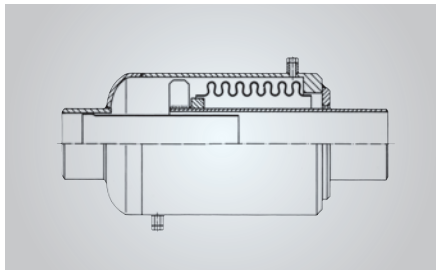


Fig. 8.8 Axial expansion joint, pressure applied externally

## Axial expansion joints for gas pipes under bridges

The axial expansion joint with externally applied pressure has been specially designed to withstand the dynamic stresses of bridge pipes. It meets very stringent safety requirements necessary for very busy road bridges.

Its features are:

- Large axial movement absorption for compensating long pipe sections
- Any aggressive condensates only wet the bellows corrugations on the outside and can drain off before corrosion occurs
- The inner sleeve provides a smooth flow
- The bellows encloses a toroidal chamber which is open at one end only and which permits a periodic leak tightness test with a suitable instrument
- The external protection cover prevents the bellows from being damaged during transport and installation, and thereby makes it more reliable
- Drain valves in the outer casing allow the pipe to be drained
- Installation is simplified by an adjustable assembly and pretension device

08

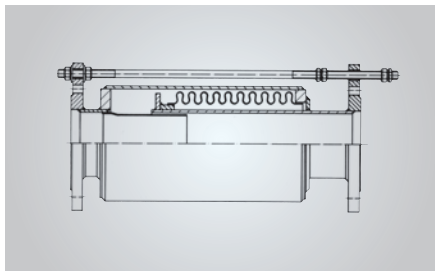


Fig. 8.9 Axial expansion joint for gas pipes under bridges

## Axial expansion joint with leakage monitoring

If critical media (toxic, explosive, flammable) are conveyed, it is reasonable to provide permanent leakage monitoring at the flexible pipe elements, to enable any leak to be detected at an early stage. The multi-ply bellows has a unique advantage – the patented leakage indicator.

Check holes in the intermediate plies, made at defined points in the cuff region of the bellows, are guided into a toroidal chamber, which is monitored for leaks. This enables detecting any damage anywhere in the inner ply early (see Chapter 10, "The Multi-ply Principle").

Other types of leakage monitoring are possible at low operating pressures using a double-ply bellows and special connection parts (Fig. 8.11) or a chamber expansion joint (Fig. 8.12).

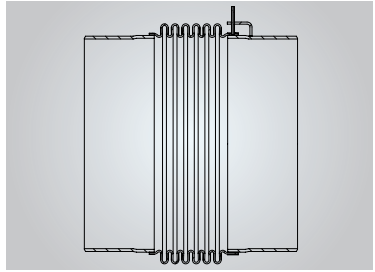


Fig. 8.10 Axial expansion joint with leakage monitoring

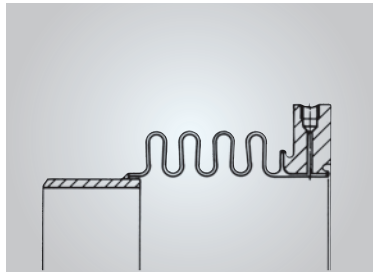


Fig. 8.11 Leakage monitoring with double-ply bellows

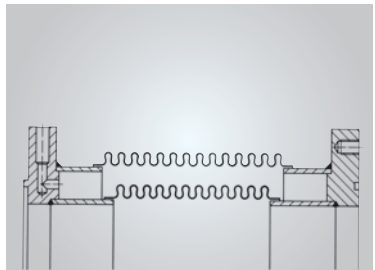


Fig. 8.12 Chamber expansion joint for leakage monitoring

## Chamber expansion joints

(Fig. 8.13)

Heated pipes or double pipes for conveying highly viscous media or media which solidify at ambient temperature require chamber expansion joints to compensate thermal expansion and to ensure "force free" connections. The chamber expansion joint with flange connection shown below is a frequently used type; the actual medium flows inside it, whilst the toroidal chamber is used for heating.

The connection for the heating fluid, e.g. steam, is provided via the flanges, usually using metal hoses (Fig. 8.13). Weld ends can also be provided as connectors instead of flanges. For cooling pipes chamber expansion can also be used. Chamber expansion joints whose toroidal chamber is fitted with a leakage detection facility can be used specifically for leak tightness testing, for example in conjunction with toxic media (Fig. 8.12).

## Expansion joints with toroidal bellows

(Fig 8.14)

This type of bellows is suitable for extremely high pressures in conjunction with relatively modest movements, which are conditions that can occur in apparatus construction. The circumferential stresses in the bellows are reduced by the thick walls of the connection parts. If several toroidal corrugations are necessary due to the required movement, reinforcing rings must be fitted between them (Fig. 8.15).

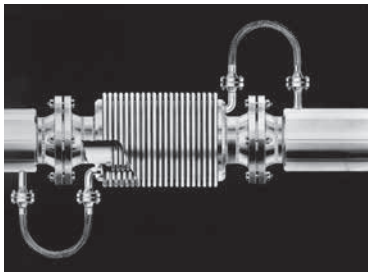


Fig. 8.13 Chamber expansion joint

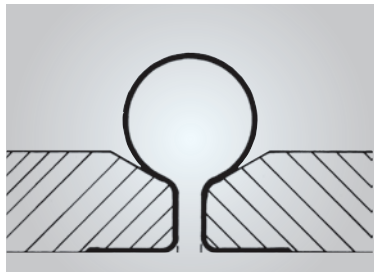


Fig. 8.14 Expansion joint with toroidal bellows

## Expansion joint with reinforcing rings

(Fig 8.15)

Reinforcing rings are used if the circumferential stresses become excessive as a result of high operating pressures, generally combined with large diameters, and it is no longer either technically possible or economically advisable to increase the number of plies or the thickness of the bellows wall. Reinforcing rings absorb the circumferential stresses instead, so that the wall of the bellows can remain relatively thin and flexible overall.

## Axial expansion joints as dismantling pieces

(Fig 8.16)

This expansion joint is used to create space for assembling and dismantling fittings. Therefore the expansion joint is loosened from the fitting and compressed with threaded rods.

At the same time the expansion joint reduces the connecting forces and moments acting on the fitting. The use of axial expansion joints is restricted by the axial pressure thrust. If the forces are too high, restrained expansion joints must be used.

08

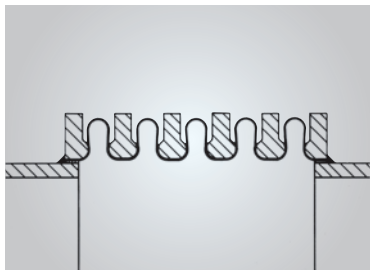


Fig. 8.15 Expansion joint with reinforcing rings

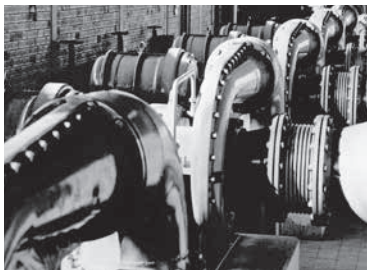


Fig. 8.16 Axial expansion joint as dismantling piece



## Expansion joints with pretensioners

(Fig. 8.17 / 8.18)

Axial expansion joints can be fitted with pretensioners to simplify assembly on the construction site.

The pretensioning bracket is set to a fixed pretension, with which the expansion joint is adjusted in the factory to the installation dimension. The bracket must be removed before the pipe is put into service (Fig. 8.17).

The adjustable pretension device, which comprises threaded rods and nuts that link the connection parts of the expansion joints together, enables the installation length to be set simply and rapidly for assembly (Fig. 8.18). See Chapter 7, Type ARH.

Pretensioners are usually only designed to absorb the adjusting forces. They cannot absorb either additional loads or the axial pressure thrust.

08

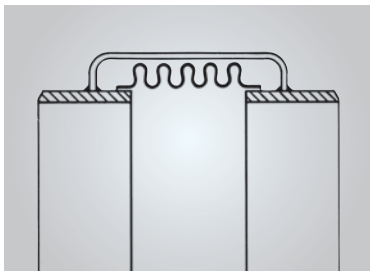


Fig. 8.17 Expansion joint with pretensioning bracket

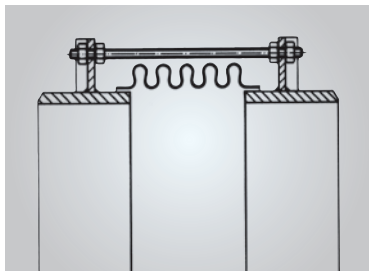


Fig. 8.18 Expansion joint pretensioned with threaded rod

## Expansion joints with stroke limitations

(Fig 8.19)

Stroke limiters can be provided for axial expansion joints if:

- The stroke must be distributed between several expansion joints in special cases
- Pressure tests must be performed during the construction work before the final anchors are secured in position
- The anchors are likely to fail or the pipe is likely to move excessively as a result of an incident (Chapter 7, Type ARH)

## Flange expansion joints with external protection cover

(Fig 8.20)

If damage is likely to be caused to the bellows by external factors due to the installation location, the expansion joints can be fitted with external protection covers. The cover can be detached from the design shown here, for example to enable the flanges to be assembled.

08

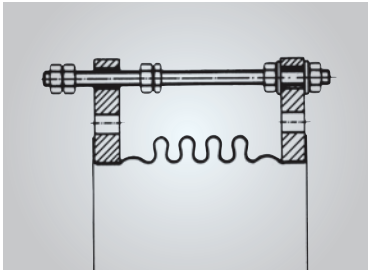


Fig. 8.19 Expansion joint with stroke limitation

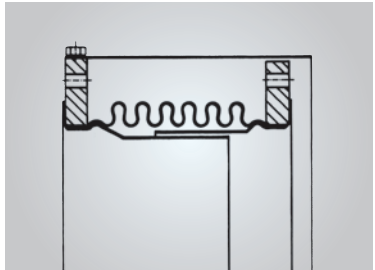


Fig. 8.20 Flange expansion joint with external protective sleeve

### Axial expansion joints with welding neck flanges

Fig. 8.22)

The axial expansion joints in the standard range are available with either loose flanges or plain fixed flanges with the same total length. The special design shown here can be supplied if welding neck flanges with a raised face are desired and the slight increase in the total length does not matter.

### Universal expansion joints as centrifuge connections

Fig. 8.23)

The universal expansion joint is designed to be highly durable in the face of large lateral vibration amplitudes and has a lateral natural frequency which is sufficiently high in relation to the excitation frequency (rotation speed) of the centrifuge.

08

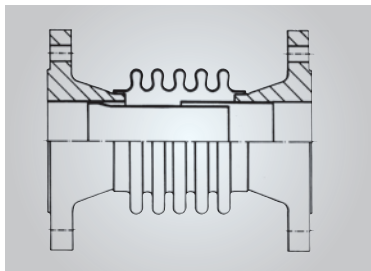


Fig. 8.22 Axial expansion joint with welding neck flanges

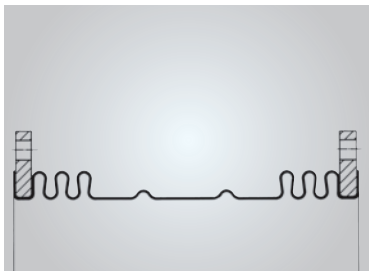
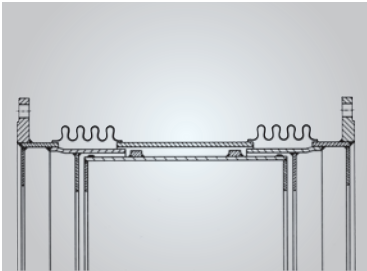


Fig. 8.23 Universal expansion joint as centrifuge connection

## Universal expansion joints for hot blast systems

Fig. 8.24)

These expansion joints are designed for axial and lateral movements. Their inner sleeve is such that large gaps can't occur, even in the extreme positions of the expansion joint, and that the weight of the fireproof internal liner can be borne.



*Fig. 8.24 Universal expansion joint for a hot blast system, DN 2500*

## Lateral expansion joints for paper machines

(Fig. 8.25)

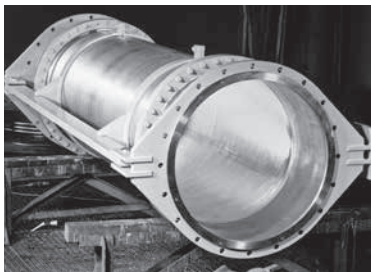
This expansion joint has been developed for connecting the head boxes of paper machines, which are required to effect a pendulum movement. The movable section comprises a reinforced PTFE liner, which is smooth and has no corrugations on the inside to prevent the conveyed material from settling. In addition to a lateral movement of up to 300 mm, it can absorb a slight angular movement of 2 to 4 deg as well as slight torsion.

## Lateral expansion joints with diffuser

(Fig. 8.26)

This expansion joint has been developed for connection to compressors. It combines an elastic expansion joint with a diffuser. As a “force free” connection, it is capable of compensating misalignment and absorbing vibrations.

08



(Fig. 8.25) Lateral expansion joint for paper machines

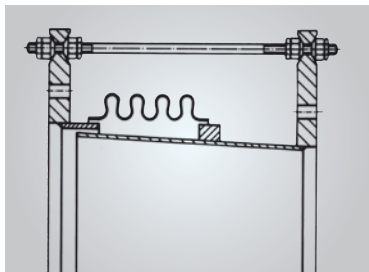


Fig. 8.26 Lateral expansion joint with diffuser

## Angular expansion joint with conical inner sleeve

(Fig. 8.27)

Internal sleeves in angular expansion joints must have a sufficient clearance to ensure flexibility. One solution is to use a one-piece, conical inner sleeve. Note: This slightly reduces the cross-section.

## Angular expansion joint with internal restraint hardware

(Fig. 8.28)

This design – in the form of a single hinge or of a gimbal hinged expansion joint – may be useful if external anchoring is not possible due to limited space. If a reduction in the cross-section is unacceptable, the anchoring can be designed to permit an almost smooth free opening. In this case, however, a larger bellows must be used. It should be noted that the internal hinge is in contact with the medium.

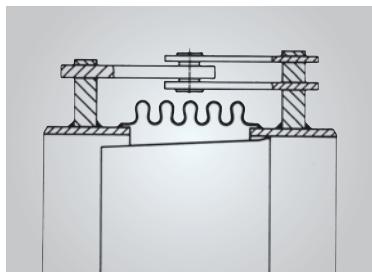


Fig. 8.27 Angular expansion joint with conical inner sleeve

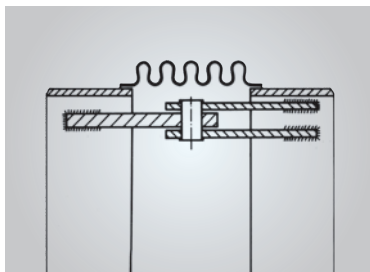


Fig. 8.28 Angular expansion joint with internal restraint hardware

## Elbow-connected pressure balanced expansion joints

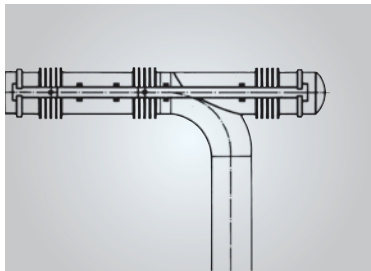
(Fig. 8.29)

The design and construction of an elbow-connected pressure balanced expansion joint is dependent on specific requirements and takes the operating conditions and the necessary movement values into account (see also Chapter 12, "Axial compressive force and pressure balanced designs"). Fig. 8.29 shows an axially and laterally flexible, elbow-connected pressure balanced lateral expansion joint.

## Angular expansion joints with PTFE bearings

(Fig. 8.30)

If the adjusting moments of our angular expansion joints, which are already small, are too high for your particular application, it is possible to reduce the frictional moment in the hinges still further by using a special bearing. The PTFE compound bearing we use for this purpose has a special design which permits it to withstand high contact pressures without the plastic antifriction coating being pushed aside. The good sliding characteristics of the bearing are thus maintained throughout the entire operating period. The bearing can withstand temperatures up to 280 °C and is absolutely maintenance-free.



(Fig. 8.29) Elbow-connected pressure balanced expansion joint

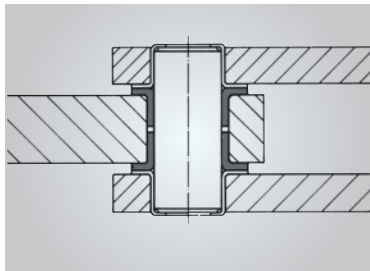


Fig. 8.30 Hinge with special bearing

## Oval expansion joints

(Fig. 8.31)

Oval expansion joints can theoretically be manufactured with any dimensions and fitted with the necessary connection parts. It is however not advisable to use them except in cases where an element with a round cross-section cannot be used.

Since expensive tools are necessary for each dimension, it is only economical to use an oval expansion joint if large quantities are required. The pressure resistance of an oval bellows is limited.

## Mechanical seals

(Fig. 8.32)

A corrugated metal bellows forms part of a mechanical seal on a rotating shaft. The bellows is assembled pressure-tight to the case, the slide ring is fitted onto the other side. The elasticity and spring force of the bellows ensures that the sealing ring always makes full contact.

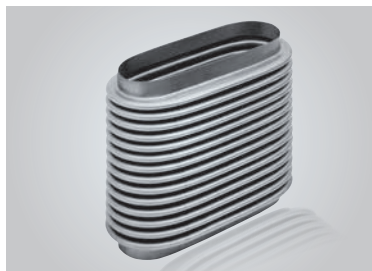


Fig. 8.31 Metal bellows with oval cross-section

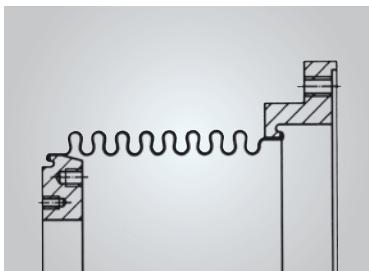


Fig. 8.32 Floating ring seal



## Volumetric compensation reservoirs

(Fig. 8.33)

A metal bellows takes care of the temperature-related, volumetric compensation of a liquid by means of expansion or compression. The movement is counter to a compressed gas cushion if the liquid is under pressure.

## Valve stem seals

(Fig. 8.34)

On valves high demands are made in terms of leak tightness and freedom from maintenance. Nowadays, they are fitted with metal bellows instead of glands for sealing the axially moved valve stem. High and highest pressures can be handled safely and maintenance-free with absolute tightness.

08

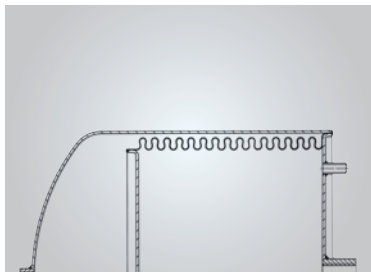


Fig. 8.33 Volumetric compensation container

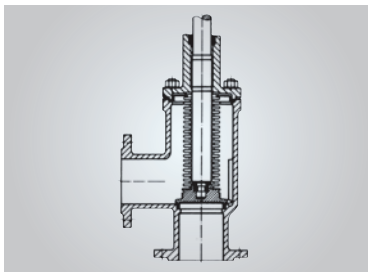


Fig. 8.34 Valve spindle seal

## Pressure cells

(Fig. 8.35)

If hydraulic pressure is applied to a metal bellows sealed with caps at both ends, the bellows can transfer a pressure-related force, similar to a hydraulic piston, whilst remaining absolutely tight. The figure shows a hydraulic element used to press-fit lock gates.

## Flexible couplings

(Fig. 8.36)

Metal bellows can be used as flexible coupling elements; they transfer torsional moments within their strength and stability limits, and compensate the axial, angular and lateral misalignment of the rotating shaft ends.



Fig. 8.35 Pressure cell

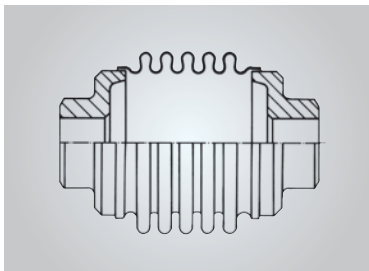


Fig. 8.36 Flexible coupling

# INSTALLATION OF EXPANSION JOINTS



Installing expansion joints in a pipe can cause substantial changes in its behaviour. Anchors and guides are subjected to different loads and the functions they must perform are not the same as in an uncompensated pipe system.

The general rules that must be considered when installing expansion joints are summarized in Chapter 16, "Installation Instructions".

This chapter describes principles to be considered when sizing and implementing the anchors, guides and supports.

It also contains information on:

- Use of lateral expansion joints within a three-hinge system
- Installation of elbow-connected pressure balanced expansion joints
- Pretensioning options

If in doubt, please make use of the advice of our specialists.

## FIXED POINTS

All compensation systems must be limited by adequately sized anchors to ensure a safe functioning of the system. There are four different types of anchors, each with different functions and loads.

### End anchors

These are either located at the ends of a compensated pipe system or used to separate two different compensation systems (Fig. 9.1). They are generally subjected to a high load.

The following forces act on end anchors:

- Axial pressure thrust (axial expansion joints only)
- Adjustment force of the expansion joint or compensation system
- Frictional force between pipe and supports
- Other plant-specific forces (wind, snow, weight of pipe or medium)

09

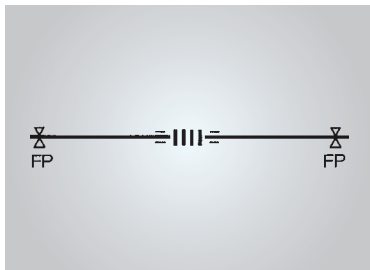


Fig 9.1 Straight pipe run with axial expansion joint and end anchors

## Intermediate anchors

These separate two expansion joints of similar construction which are necessary in long, straight pipe runs, and are generally only subjected to a slight load (Fig. 9.2).

The following differential forces act on intermediate anchors:

- Axial pressure thrust (axial expansion joints only) if different nominal diameters must be separated or if there are pressure differences (flow losses at throttles or valves). Axial expansion joints made by different manufacturers usually have different pressure thrusts, which can result in considerable differential forces even if the nominal diameter is the same.
- Adjustment force if expansion joints of different lengths and with different movements are used. Even if the expansion joints and the movements are the same, a differential force which is 30 % of the adjustment force should be assumed, since the spring rates of the expansion joints are subject to fluctuations in this region due to production and material tolerances.
- Frictional force between the pipe and guides. Particular attention should be paid to this point, since the frictional forces may differ substantially during operation depending on the type of support.
- Other plant-related forces, which must be taken into account when calculating the load on the anchors.

The intermediate anchor becomes an end anchor during pressure tests in a section of the pipe or if the system contains a gate valve.

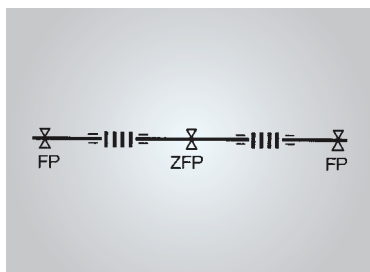


Fig. 9.2 Straight pipe run, subdivided into two compensated sections by intermediate anchor

## Sliding anchors

These serve to guide the pipeline, but must act as normal anchors in at least one direction, e.g. if universal expansion joints are used (Fig. 9.3). The same forces act on sliding anchors as on end anchors. It should be noted in addition that a large frictional force is generated at the sliding anchor due to the high anchor force which is active there. This frictional force must also be taken into account when sizing the end anchor  $FP_1$ .

## Elbow anchors

These separate two identical compensation systems at the crown of a pipe elbow. This type of anchor is a mixture of an end anchor and an intermediate anchor. The same forces must consequently be taken into account as with end anchors, in addition to the differential forces that occur with the intermediate anchors if the bends are too small.

The redirection of the flow in the pipe elbow results in a centrifugal force, which must also be absorbed by the elbow anchor if an axial compensation system is used. This force is usually negligible, however. The individual force components must be added together geometrically, in order to obtain the magnitude and direction of the resulting anchor force  $F_{res}$ .

09

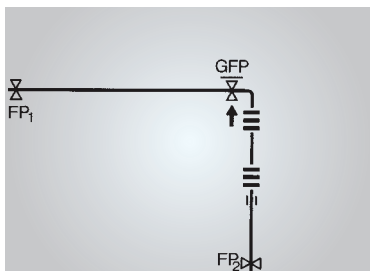


Fig. 9.3 Bent pipeline with universal expansion joint and one sliding anchor

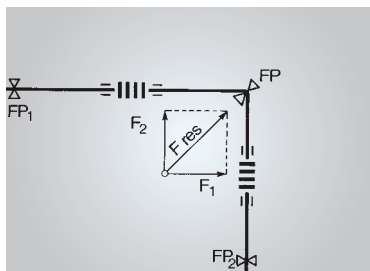


Fig. 9.4 Bent system with axial expansion joints and elbow anchor

# ANCHOR FORCES

## Axial pressure thrust

Chapter 12 "Axial Pressure Thrust and Pressure-balanced Designs" describes the origin and effect of the pressure thrust in detail, the calculation formula will suffice at this point.

## Axial pressure thrust $F_p$ in kN

(axial compensation only)

$$(9.1) \quad F_p = 0.01A \cdot p$$

Effective cross-section  $A$  in  $\text{cm}^2$  (see dimension table of the axial expansion joints)  
Pressure  $p$  in bar (take maximum pressure, e.g. test pressure)

If the internal pressure is greater than the external pressure, the expansion joint will be elongated by the pressure thrust without anchors, whereas if the external pressure is greater than the internal pressure, it will be compressed. If pressure tests are performed section by section during construction of an extensive pipe system, and if the strong end anchors are not locked in position, axial expansion joints must be protected by suitable stroke limiters (see Chapter 7 Type ARH, for example), or alternatively the intermediate anchors must be made correspondingly stronger.

09

## Adjustment force of the compensation system

The axial spring rate  $c_\delta$  is specified in the dimension tables for axial expansion joints. The adjustment force is calculated as follows:

## Axial adjustment force $F_\delta$ in kN

$$(9.2) \quad F_\delta = 0.001c_\delta \cdot \delta$$

Axial spring rate  $c_\delta$  in  $\text{N/mm}$

(taken from dimension tables for axial expansion joints)

Half overall movement absorption  $\delta$  in  $\text{mm}$  (with 50 % pretensioning)

In hinge systems, the adjusting forces are more difficult to calculate than for axial expansion joints. Calculation programs are normally used to determine these forces (e.g. ROHR2 or CAESAR II).



## Frictional force between pipe and supports

The entire frictional force of the pipe section between the compensation system and the anchor, i.e. the sum of the frictional forces of all supports, acts on each anchor.

### Frictional force $F_R$ in kN

$$(9.3) \quad F_R = \Sigma F_L \cdot K_L$$

Support load  $F_L$  in kN

Friction coefficient of support  $K_L$  :

Empirical values for  $K_L$ :

Steel / steel: 0.2 – 0.5

Steel / PTFE: 0.1 – 0.2

Roller bearings: 0.05 – 0.1

09

It should be considered that the frictional force acts on an anchor in alternating directions – as a pressure thrust when the pipe is heated up and as a tensile force when it is cooled down.

The distribution of the frictional-force components acting on the two anchors can be altered by changing the arrangement of the compensation system along the pipe section between the anchors. If, for example, the compensation system is positioned directly at an anchor, this anchor ( $FP_1$ ) must not absorb any frictional force; on the other hand, the second anchor ( $FP_2$ ) must absorb the entire frictional force of this section (Fig. 9.5).

If the compensation system is positioned centrally between both anchors, each anchor must absorb half the frictional force of the complete section (Fig. 9.6).



Fig. 9.5 Asymmetrical arrangement of the expansion joint. Frictional force acting on one anchor.

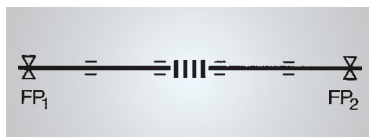


Fig. 9.6 Symmetrical arrangement of the expansion joint. Frictional force distributed uniformly.

### Centrifugal force in kN

This is only released at the elbow anchors of axially compensated pipes, and is generally negligible (Fig. 9.7). A significant force is only generated by heavy media with a high flow velocity.

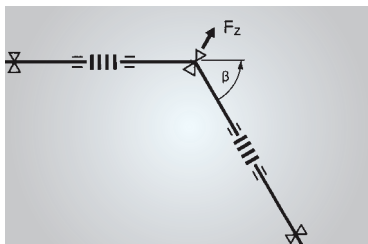


Fig. 9.7 Centrifugal force at the elbow anchor

### Centrifugal force $F_z$ in kN

$$(9.4) \quad F_z = \frac{A \cdot \rho \cdot v^2 \cdot \sin\beta}{10,000}$$

Effective cross-section A in  $\text{cm}^2$  (see dimension tables for axial expansion joints)

Density of medium  $\rho$  in  $\text{g/cm}^3$

Flow velocity v in m/sec

Angle of pipe elbow  $\beta$  in degrees

### Other plant-related forces

In addition to the forces generated as a direct result of the installation of expansion joints, the anchor sizing must also take into account those forces produced by the system or the pipeline route, or by additional loads:

- Weight of pipe, medium and insulation
- Weight of dust deposits both inside and outside
- Weight of condensate
- Wind and snow loads
- Forces due to mass acceleration in event of an earthquake
- Forces due to pipe deformation as a result of inadequate compensation

***If pipes used for gaseous media are subjected to a water pressure test, the weight of the water must be taken into account in addition.***

## GUIDES

Particular attention must be paid to the pipe guides in the region of expansion joints or compensation systems. The different requirements of the compensation systems must be taken into account.

### Guides for axial compensation

The conditions dictated by the plant must always be taken into consideration when sizing supports and calculating the distances between the supports. The following rules must also be observed if axial expansion joints are used:

- The first guide after the axial expansion joint must be no more than  $3 \times \text{DN}$  away from the expansion joint, i.e.  $L_1 \approx 3 \cdot \text{DN}$  (Fig. 9.8)
- The distance between the first and second supports after the expansion joint must be approximately half the normal distance between supports, i.e.  $L_2 \approx 0.5 \cdot L_F$  (Fig 9.9)
- The normal distance between supports  $L_F$  may have to be reduced if there is a risk of pipe buckling (Fig. 9.10)

09

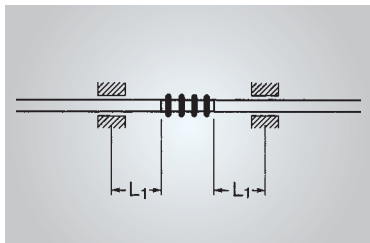


Fig. 9.8 Guide installed directly at axial expansion joint

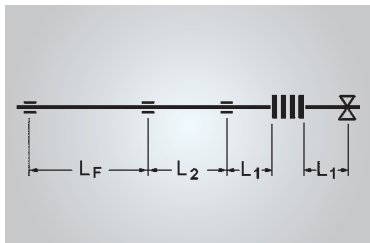


Fig. 9.9 Guide installed in pipe

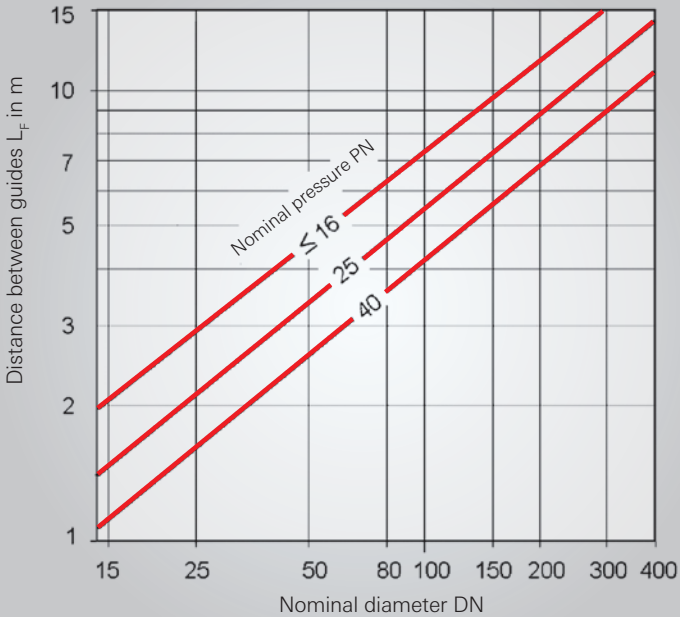


Fig. 9.10 Distances between pipe guides for axial compensation (approx. values)

## Guides for lateral compensation or double-hinge systems

In the case of lateral compensation, there is always a "residual elongation" which must be absorbed by bending the pipe.

This residual elongation is made up of two components:

- Thermal expansion in the uncompensated pipe section (with expansion joint)
- Arc height derived from the circular movement of the lateral expansion joint or the two angular expansion joints (Fig. 9.11)

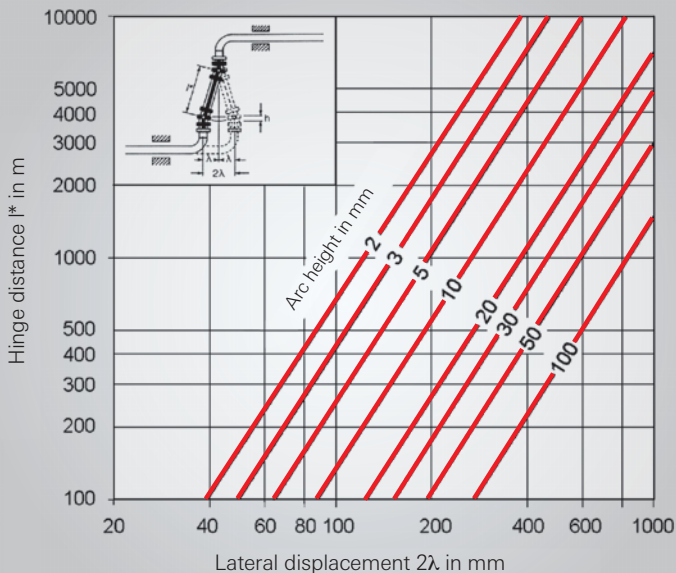


Fig. 9.11 Length variation of a double-hinge system with lateral movement (arc height)

## Arc height $h$ in mm

$$(9.5) \quad h = l^* - \sqrt{l^{*2} - \lambda^2}$$

Hinge distance  $l^*$  in mm

half lateral displacement  $\lambda$  in mm

Sufficient freedom of movement must therefore be permitted at one end of the expansion joint respectively the double-hinge system, or otherwise reactive forces will occur (Fig. 9.12).

Guide 3 must have sufficient clearance in order not to impede the residual elongation. In other words, it is only a guide in one direction. In vertical systems, the guide can be omitted if there are no forces and if vibrations are not possible. Guides 2 and 4 must be able to absorb the bending forces of the pipe.

If long intermediate pipes are installed in horizontal systems, they must be supported in order to prevent excessive lateral forces from acting on the expansion joint (Fig. 9.13).

The slip plane of the supports must always be perpendicular to the pivots of the expansion joints.

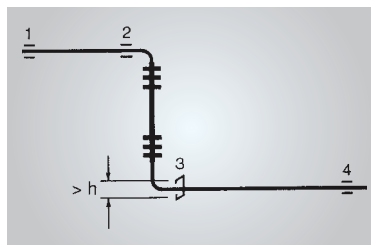


Fig. 9.12 Vertical double-hinge-system

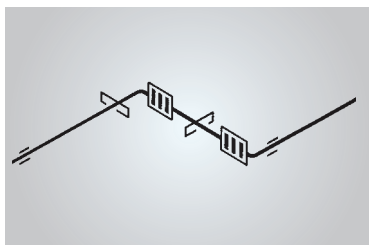


Fig. 9.13 Horizontal hinge-system on sliding guides

Flexible hangers or supports must be provided for vertical systems or systems which are flexible on all planes and for heavy loads (Figs. 9.14 and 9.15).

It should be noted that pipe bending from residual elongations causes additional forces on the restraint hardware of the expansion joint. For vacuum service or unusual pretensioning of the expansion joints, the additional bending forces placed on the restraint hardware may be so heavy that reinforcement is necessary. In this case, the additional forces must be specified in inquiries and orders.

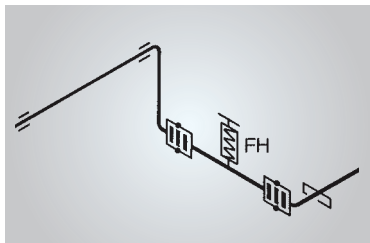


Fig. 9.14 Horizontal double-hinge system with suspended intermediate pipe

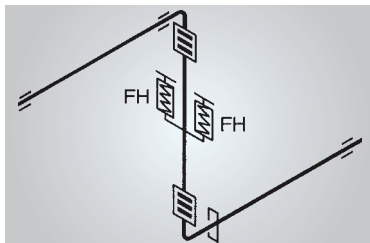


Fig. 9.15 Vertical double-hinge system with suspended intermediate pipe

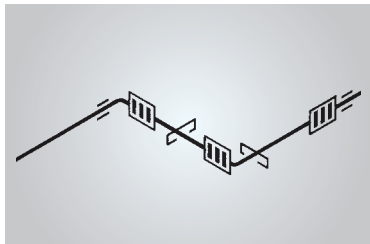


Fig. 9.16 Plane three-hinge system with both intermediate pipes supported

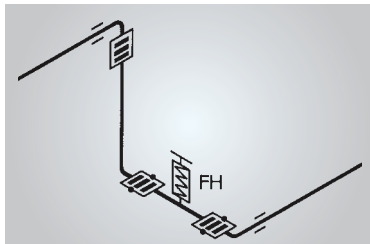


Fig. 9.17 Three-hinge system with suspended intermediate pipe flexible on all planes

## Guides for three-hinge systems

The loads placed on the guides of three-hinge systems are only slightly greater than those placed on standard pipe guides. The only additional loads are the adjusting forces of the system, which are usually small.

Special attention should be paid to the absorption of the weight of the pipe sections between the angular expansion joints. These sections are often long and their weight can place an excessive load on the expansion joints.

The examples below demonstrate load transfer by means of supports or spring hangers.

If a plane three-hinge system is installed at an inclination angle  $\alpha$  (Fig. 9.19), it is important to ensure that the pin axes are always parallel to one another and perpendicular to the support plane, i.e. the axes of the expansion joints must be inclined by the angle  $\alpha$  when they are installed.

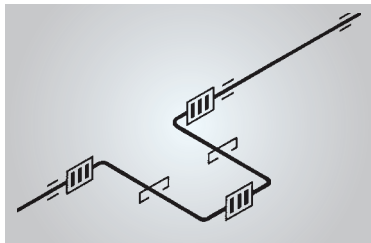


Fig. 9.18 three-hinge system in U-configuration with pipe legs supported at centre of gravity

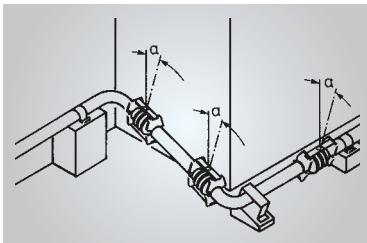


Fig. 9.19 Inclined three-hinge system



## INSTALLATION NOTES

### Restraint hardware orientation of lateral expansion joints

Almost all lateral expansion joints have two tie rods or hinged tie bars, which give them additional angular flexibility in one plane (Fig. 9.20). The same applies to lateral expansion joints for movement in all planes. Lateral expansion joints cannot be bent in the second plane, since the restraint hardware works like a parallelogram in this plane (Fig.9.21).

As mentioned earlier in the "Guides" section of this chapter, there is always an uncompensated movement component, which must be absorbed by bending the pipe, when lateral expansion joints (double hinges) are used. The pipe can be bent in different ways depending on the position of the restraint hardware.

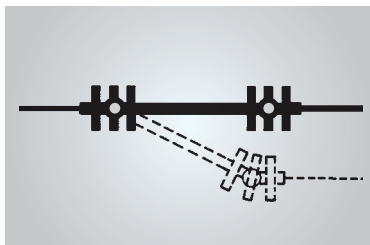


Fig. 9.20 Lateral expansion joint, flexible on all planes. Deflection transversal to anchor plane

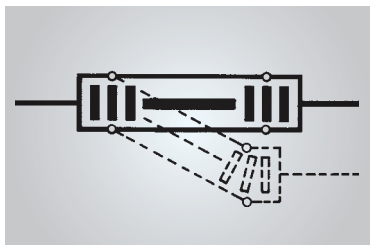


Fig. 9.21 Lateral expansion joint, flexible on all moments. planes. Deflection in anchor plane

## Deflection transversal to restraint hardware plane

The pipe is bent in approximately the manner of a beam clamped at one end (Figs. 9.22 and 9.24), since the small adjusting moment of the expansion joint is insignificant. Thus, the free bending length can be kept relatively short and the additional loads on the expansion joint remain small.

## Deflection in restraint hardware plane

The pipe is bent in approximately the manner of a beam clamped at both ends, since the restraint hardware transfers a significant moment (Figs. 9.23 and 9.25). The S-bend resulting in the pipe necessitates a much greater free length than in the first example. In addition, much greater moments and forces are generated and may place an excessive load on the hardware of the expansion joint.

Potentially the load-bearing capacity of the restraint hardware must be checked on the basis of the additional forces and moments.

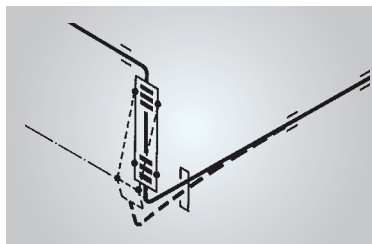


Fig. 9.22

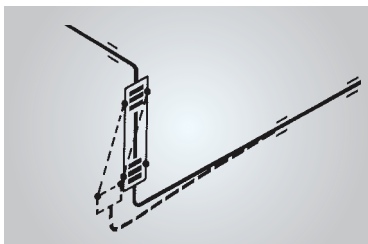


Fig. 9.23

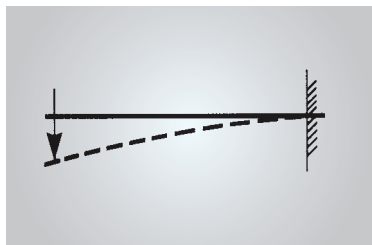


Fig. 9.24

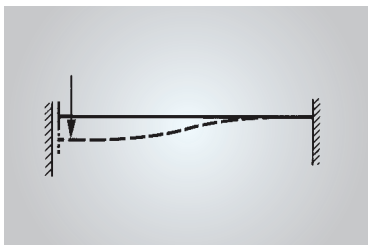


Fig. 9.25

### Two lateral expansion joints arranged at an angle

Two short lateral expansion joints are often arranged above a corner in order to cope with small, lateral movements in all planes or with vibrations at machine connections (Fig. 9.26).

In this case, it is important to ensure that the pairs of tie rods or hinged tie bars belonging to the two expansion joints are offset 90° in relation to one another. This prevents the connecting pipe elbow from tilting excessively, which would cause the expansion joints to fail prematurely.

### Combination of lateral and angular expansion joints in a three-hinge system

Since one lateral expansion joint has the same kinematic characteristics as two angular expansion joints with an intermediate pipe, it is also possible to construct a three-hinge system with one lateral expansion joint and one angular expansion joint.

If the hinge system is installed in a confined space, especially if it is a 3-dimensional system, it may be cheaper to use a combination of angular and lateral expansion joints. Purely angular systems are usually cheaper if large hinge distances are desired (greater than 5 x DN).

***The restraint hardware of the lateral expansion joint must be arranged in the system so that an angular movement towards the angular expansion joint is allowed*** (Figs. 9.27 and 9.28). The lateral expansion joint functions like a parallelogram with regard to transversal movements in a 3-dimensional system.

Only lateral expansion joints with hinge pins located exactly above the centre of the bellows should be used. If the lateral expansion joints have tie rods or if they have hinges located away from the centre of the bellows, it is considerably more difficult to calculate the bending angles, the forces and moments and the stability of the system.

This pipe system must always be examined by the expansion joint manufacturer to ensure that it can function properly, even if no problems are apparent after the initial, rough calculations.

Lateral expansion joints with more than two tie rods cannot be used in a three-hinge system.

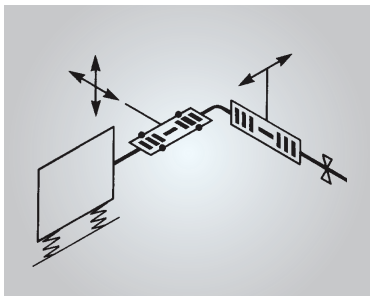


Fig. 9.26 Lateral expansion joint in an angular configuration at a vibrating aggregate

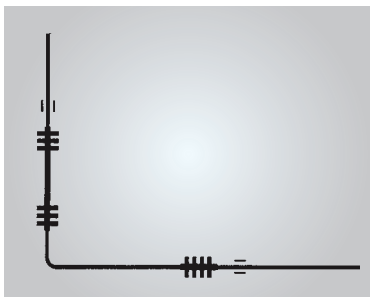


Fig. 9.27 Plane three-hinge system with lateral and angular expansion joints

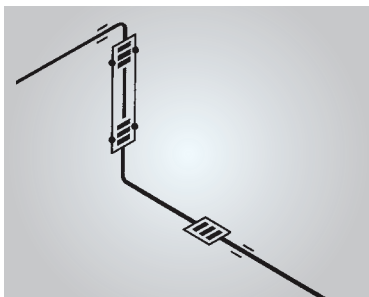


Fig. 9.28 3-dimensional three-hinge system with lateral and angular expansion joints

### Installation of elbow-connected pressure balanced expansion joints

Elbow-connected pressure balanced expansion joints are restrained expansion joints in which the axial pressure thrust produced by the internal pressure is not released.

Axial and lateral movements can be absorbed simultaneously. An additional, angular flexibility on all planes can be achieved using special designs (see also Chapter 12 "Axial Pressure Thrust and Pressure-balanced Designs").

A further advantage of this construction type is its compact dimensions. These enable complex movement problems to be solved in confined spaces in combination with the advantage of small connecting forces.

The principle applications should now be apparent, namely connections for pumps, compressors and turbines in restricted spaces.

Elbow-connected pressure balanced expansion joints are normally designed specially to suit particular operating and installation conditions. The examples described below demonstrate the special advantages of this construction type and indicate points which should be noted when it is installed.

If ***elbow-connected pressure balanced expansion joints*** are used for ***pump connections*** (Fig. 9.29), it is possible to achieve low-stress machine connections, which are flexible on all planes, and low space requirements, as well as a vibration decoupling with small movable masses.

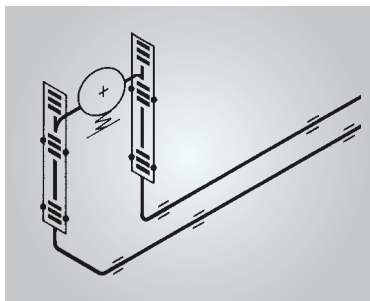


Fig. 9.29 Elbow-connected pressure balanced expansion joints used as pump connections

An **elbow-connection pressure balanced expansion joint** installed between a **turbine and a condenser** can provide a connection which requires only a relatively small vertical distance (Fig. 9.30).

The connection on the turbine side can also be made with a rectangular cross-section.

A pressure balanced expansion joint can be used in a long pipe section to absorb larger movements (Fig. 9.31).

The movement is effected by means of an extremely small pipe offset. Unlike with the three-hinge system, no lateral deflection needs to be considered. A small clearance may be left merely in the guides directly at the expansion joints for the thermal expansion resulting from the distance between the axes of the two pipe runs, in order to relieve the load on the bellows.

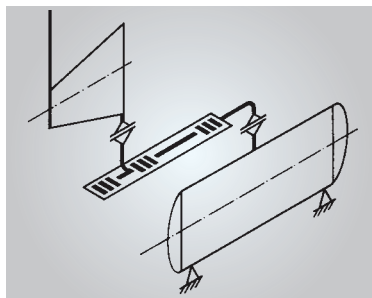


Fig. 9.30 Elbow-connected pressure balanced expansion joint between turbine and condenser

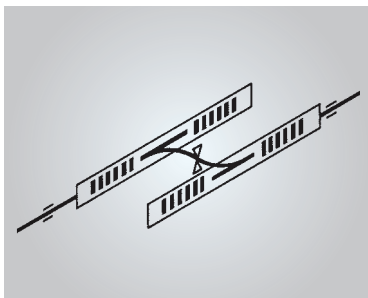


Fig. 9.31 Elbow-connected pressure balanced expansion joint in a long pipe section for absorbing large movements

## PRETENSION

Pretension is often necessary in order to exploit the full movement capability of an expansion joint. Each expansion joint can effect movements of an identical magnitude in both directions from the neutral position. Accordingly the optimum presetting value would be 50 % of the total movement.

In the case of axial expansion joints, lateral expansion joints and angular expansion joints in a double-hinge system, the pretension as a proportion of the pipe expansion corresponds to the pretension of the expansion joint itself.

In three-hinge systems with angular expansion joints this is usually the case as well. In unfavourably designed systems, however, the pipe pretension should be calculated with particular care, since it is no longer necessarily proportional to the angular deflection of the individual angular expansion joints.

Since it is difficult to pretension an expansion joint directly when it is assembled, it is advisable to assemble the expansion joints in their neutral positions and to pretension the complete pipe run later on, either by displacing before securing the anchors or afterwards using an adapter which has been cut out.

It should be noted that a pretension is not always purely elastical, i.e. that the expansion joint does not necessarily move back to the nominal length after releasing the pretension.

### Axial expansion joints

The expansion joint is welded at one end to the pipe (Fig. 9.35/1). This section of the pipe has already been secured, so that the expansion joint can be pretensioned subsequently without it being displaced. The pipe section to be connected is lying loose in the guides (Fig. 9.35/3). The pipe section to be connected is then pulled to the point of contact (Fig. 9.36/4) and welded to the expansion joint (Fig. 9.36/5).

After welding the loose pipe, it is pulled away from the expansion joint in an axial direction, using a wrench or other suitable device, by the magnitude of the pretension value (Fig. 9.37/6). When doing so, care must be taken to ensure that the expansion joint is not overextended (Fig. 9.37/7). This section of the pipe is now also secured, so that the expansion joint no longer draws the pipe towards it when released by the pretensioner (Fig. 9.37/8).

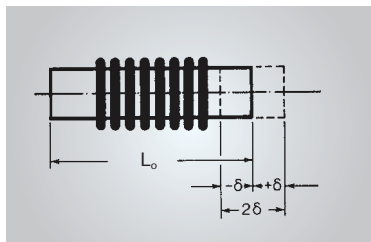


Fig. 9.32 Axial expansion joint with total length  $L_0$  (neutral position)

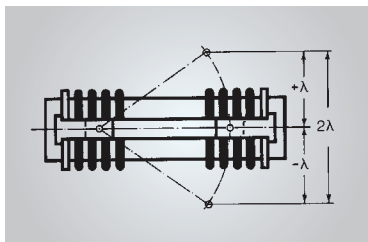


Fig. 9.33 Lateral expansion joint

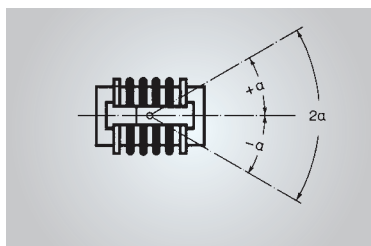


Fig. 9.34 Angular expansion joint

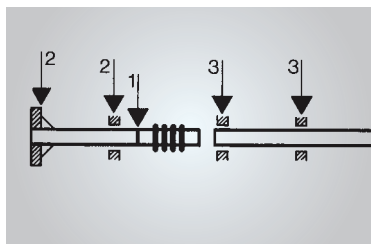


Fig. 9.35

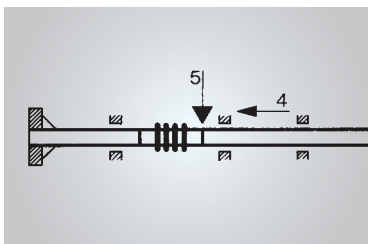


Fig. 9.36



Axial expansion joints can also be ordered already pretensioned. This ensures that they are always pretensioned to the correct value at the construction site. Of course, it is also possible to dispense with pretensioning if the movements are so minimal that the permissible deflection of the expansion joint in one direction from the neutral position is not exceeded.

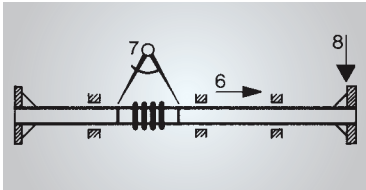


Fig. 9.37

09

### Lateral-expansion joints

The end anchors are secured at both ends (Fig. 9.38/1). The expansion joint is welded in at a neutral position (Fig. 9.38/2). The pipe to be connected is spaced at a distance corresponding to the pretension value  $V$  (Fig. 9.38/3). This must be ensured by means of a detachable adapter or by cutting out a pipe section of the length  $V$ . The expansion joint is pulled or pushed away from its neutral position by the pretension value (Fig. 9.39/4), then connected rigidly to the pipe run (Fig. 9.39/5). For lightweight expansion joints this can be done manually, otherwise an adequate tool is necessary.

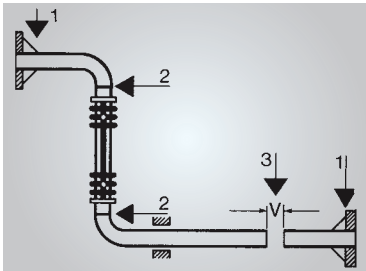


Fig. 9.38

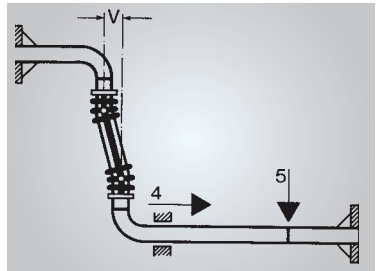


Fig. 9.39

## Angular expansion joints

The end anchors are secured at both ends (Fig. 9.40/1). The angular expansion joints are welded or flanged in their neutral position, i.e. perpendicular to the incoming pipe runs (Fig. 9.40/2).

The pipes to be connected are spaced at a distance corresponding to the pretension values, or alternatively, a pipe section corresponding to the pretension value can be cut out (Fig. 9.40/3).

The expansion joints, which are already operating jointly, must then be pulled or pushed away from their neutral position by the pretensioning value (Fig. 9.41/4) and rigidly connected to the pipe runs (Fig. 9.41/5). For lightweight expansion joints this can be done manually, otherwise an adequate tool is necessary.

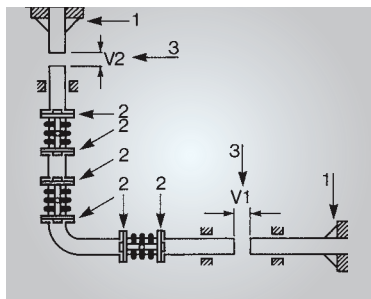


Fig. 9.40

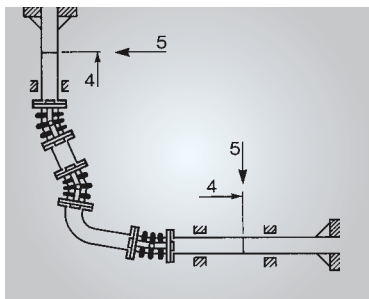


Fig. 9.41

# THE MULTI-PLY PRINCIPLE

The “multi-ply” principle is based on the idea of subdividing the pressure-bearing wall into a large number of thinner, individual plies, and thereby considerably increase the flexibility, which is the most important characteristic of an expansion joint (cf. wire rope as opposed to steel rod).



## Physical relationships

It becomes apparent merely by considering a simple bending beam (Fig. 10.1) that if the bending and all other dimensions remain the same whilst the beam height is halved, the bending stress is likewise halved and the adjusting force of the double-ply bending beam is reduced to just one quarter of its original value.

Similar conditions basically prevail in the corrugations of a metal bellows. The interrelationships below demonstrate how flexibility, pressure resistance and adjusting force depend on the most important geometrical parameters of the corrugation in an initial approximation (see also Chapter 11 "Design of the Bellows").

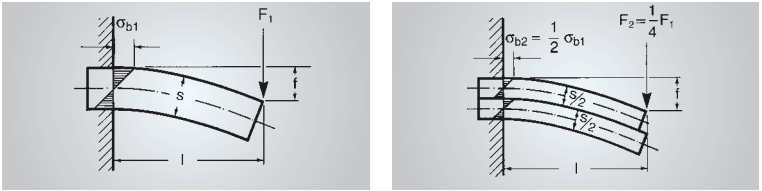


Fig. 10.1 Single and double-ply bending beam with stress profiles

### Pressure

$$(10.1) \quad p \sim n_p \left( \frac{e_p}{W} \right)^2$$

### Axial movement absorption

$$(10.2) \quad x \sim \frac{W^2}{e_p}$$

### Axial spring rate

$$(10.3) \quad k \sim n_p \left( \frac{e_p}{W} \right)^3$$

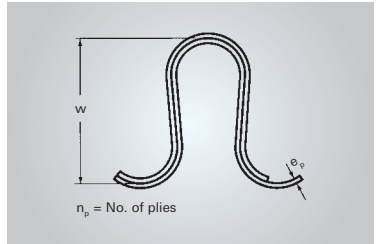


Fig. 10.2 Physical relationships for a bellows corrugation (approximation)

The relationships take into account the number of plies; this reveals the positive effect of a large number of plies on a high pressure resistance combined with good flexibility. ***Whilst increasing the number of plies causes the pressure resistance to be increased linearly, the flexibility remains unaffected.***

Although these relationships are much more complex and less easy to formulate in reality, the potential for adapting the multi-ply expansion joint optimally to specific operation conditions is readily apparent.

### Bellows structure

The multi-ply bellows is made using a multi-ply cylinder package.

The multi-ply cylinder package is formed into a multi-ply bellows by pressing out circular corrugations (Fig. 10.3). The plastic stretching of the material which occurs during this process is also a reliable test of the quality of the longitudinal weld seam of the cylinders.

The individual tight cylinders may be made of different materials if desired, which opens up various economic possibilities, for example, of countering corrosion.

10

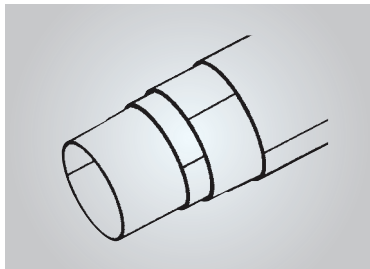


Fig. 10.3 Multi-ply cylinder package

## Material quality

Using cold-rolled strip material in only a few thicknesses – it is usually the number of plies which is varied – enables the material to be procured in large quantities, in order to influence positively the characteristics of the raw material which are particularly important for manufacturing bellows, such as dimensional tolerances, surface quality, strength values and formability. The desired characteristics and data are laid down in our ordering and acceptance specifications. Our strip material is certified with the inspection certificate according to EN 10204-3.1/3.2. The most important materials are permanently available in stock.

## Technical characteristics

A number of highly positive expansion joint characteristics result from structuring the bellows with a large number of individual plies:

- Ability to cope with high pressure combined with excellent flexibility
- Large movement combined with small total lengths and a guaranteed number of load cycles (usually 1000)
- Small adjusting forces in relation to other designs
- Small bellows outside diameters and consequently small effective cross-sections for reduced loads on anchors
- High burst pressures – at least three times the nominal pressure

# BENEFITS AND SAFETY OF MULTI-PLY EXPANSION JOINTS

## Economic benefits

The large movement absorption of multi-ply HYDRA expansion joints means that only **a few expansion joints are necessary** to compensate occurring movements, such as thermal expansion, and that the costs are reduced accordingly (fewer shaft constructions are required, for example).

The more compact dimensions of the multi-ply bellows result in shorter total lengths of the expansion joints and in reduced protrusion of the restraint hardware of hinged expansion joints as well as small outside diameters of potential outer protection covers. This again results in **cost savings** with regard to the shaft constructions, since these can manage with much smaller dimensions.

The smaller adjusting forces of the multi-ply HYDRA expansion joint reduce the expenditure for anchors, and thus allow effective, economical compensation in a small place, e.g. hinge systems with very short leg lengths.

10

If they are planned correctly and installed in accordance with our instructions, multi-ply HYDRA expansion joints protect machine connections from forces and moments and dampen vibrations. Thus, they help to maintain failure-free operation and **reduce repair costs**.

A number of different bellows materials can be used to counter the risk of corrosion, providing they are sufficiently formable – the **most economical method is to use the expensive corrosion-resistant material only for the ply which is in contact with the aggressive medium** and to use our standard stainless steel 1.4541 for the remaining plies. It is however essential to ensure that the different bellows materials can be welded to one another and to the connection parts, or alternatively that loose flanges can be used.

## Safety principle

In addition to the safety which is guaranteed by the reliable design and accurate manufacturing, multi-ply HYDRA expansion joints offer a notable advantage with regard to safety, namely the **check hole for leakage monitoring** (Fig. 10.4).

If the ply of the multi-ply expansion joint which is in contact with the medium develops a leak, for example as a result of corrosion, a weak flow of the conveyed medium gets out of the expansion joint through the ply interspaces; the onset of damage is indicated by a slight leakage at the “check holes” in the bellows cuff (covered by collars). Pressure resistance and functionality of the expansion joint are maintained in such cases for a lengthy period of time (weeks or months). It is therefore not necessary to replace it immediately. This can be left until a later date which is more convenient to the operator. A replacement expansion joint can be procured within the normal delivery period without the need for any special action.

***There is no need to store spare expansion joints.***

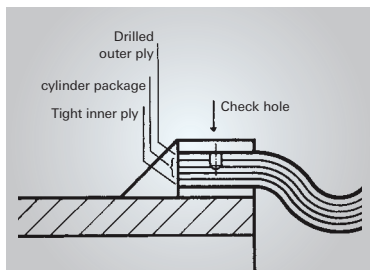


Fig. 10.4 weld seam and check hole

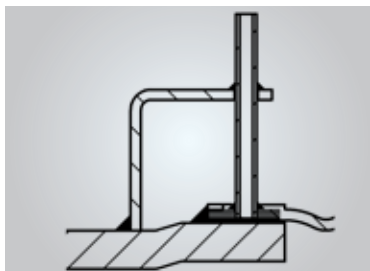
***Based on our many years of experience, we can state that spontaneous bursting of HYDRA multi-ply bellows is not possible under any circumstances.***



### Permanent leak monitoring

When used in plants with toxic, flammable, explosive or other critical media, multi-ply Witzemann expansion joints can be monitored permanently for leaks without any risk of the critical medium escaping if damage occurs.

For leak monitoring a welded measurement pipe is placed from the outer to the inner layer of the bellows tangent. An instrument can be connected to the measurement pipe (Fig. 10.5). The instrument outputs an alarm if the pressure rises, so that any onset of damage to the inner ply is indicated at absolutely no risk. Even large pipe systems, such as gas distribution systems, can be monitored completely, reliably and economically by this method.



10

Fig. 10.5 Leak monitoring

## Noise damping

Multi-ply bellows have a movement hysteresis due to mutual effect of the plies on one another and to the effect of friction (Fig. 10.6).

The damping resulting from energy consumption has an extremely positive effect on the insulation of structure-borne noise. Multi-ply bellows can reduce this noise by up to 20 dB in the same way as rubber elements.

The outstanding characteristics of multi-ply HYDRA expansion joints have proven to be a good and often the only useful solution in practical application - especially in the area of higher pressure - for many years thanks to their excellent properties.

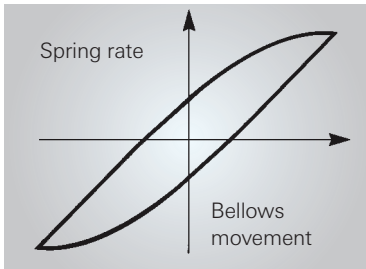
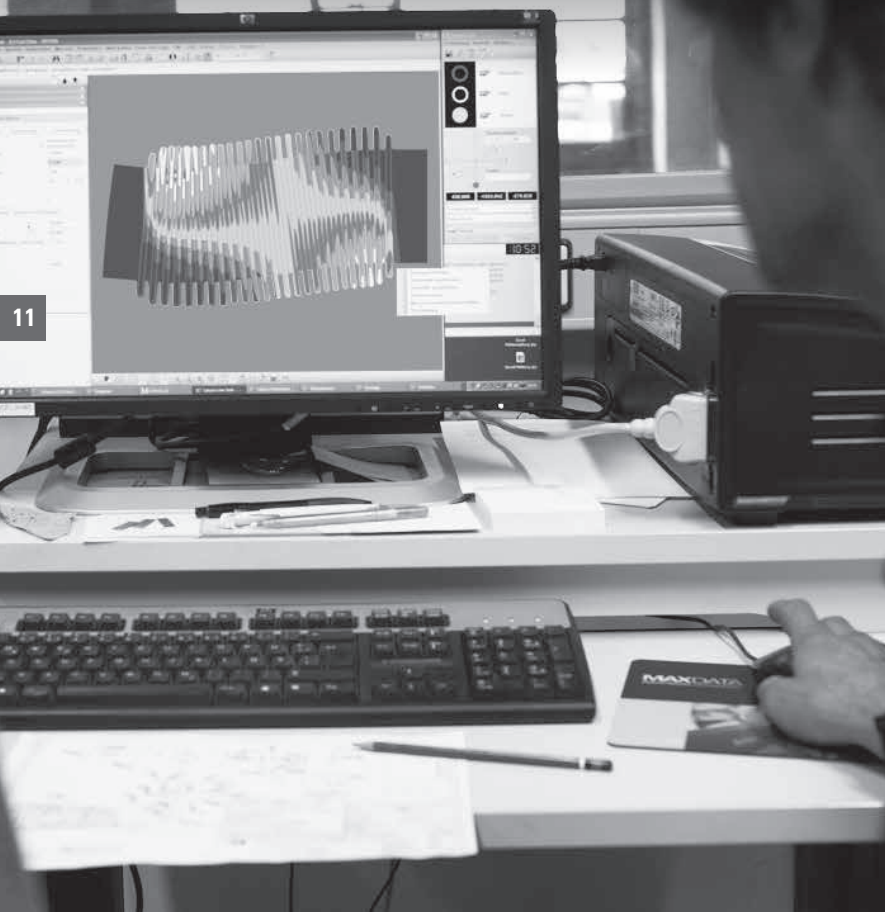


Fig. 10.6 Hysteresis loop during over-elastic cyclic load

# DESIGN OF THE BELLOWS

11



## Introduction

A corrugated metal bellows must meet two contradictory demands – namely pressure resistance on one hand and flexibility with regard to relatively large, cyclic movements on the other hand – giving almost equal priority to both. This also differentiates the metal bellows from other pressure-bearing components, such as vessels and pipes, where pressure resistance is essential, whilst other imposed cyclic loads generally play a subordinate role and are only calculated approximately as additional loads.

The aim when designing an expansion joint bellows is to establish a design which allows the two demands to be met optimally in both technical and economic terms.

According to the latest state of the art – which is based on several decades of experience – the construction principle of double and multi-ply expansion joints provides the best basis for achieving an optimised system.

On the other hand, using several plies further complicates the already difficult calculation of the lyre-shaped bellows as a doubly-curved shell. A reliable method of designing and sizing expansion joints is however indispensable, since the safety of a plant and the operating personnel may depend on it.

For this reason, we have developed an individual calculation method. This calculation method is basically founded on EN 13445-3 and EN 14917 and was complemented by supplements of operational experience and test results. The method was examined by an independent third party inspection agency (TÜV); an equivalent safety level in the sense of directive 2014/68/EU was demonstrated.

## Theoretical basis

The calculation method applied in standards (EN 13445, EN 14917,...) and rules (EJMA, ASME,...) is founded on the calculation method which was developed by Anderson for the Atomic Energy Commission, USA and published in 1964/65. This method takes a flat, non-curved plate strip with a height  $w$ , corresponding to the height of the corrugations, as a simplified, substitute model for a bellows half-corrugation (Fig. 11.1). The equations required to calculate this substitute model are set up, and then corrected with factors which take into account the effect of the real shell shape of the bellows corrugation.

Anderson provides the correction factors in the form of a graph; they have been determined analytically by means of shell equations and take the laws of similarity into account. The method provides clear equations in line with the simplified, yet elegant, approach (Fig. 11.1).

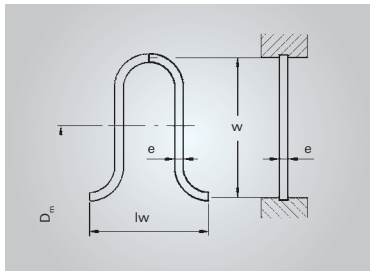


Fig. 11.1 Bellows and analogous model for the calculation according to Anderson.

11

The equations can principally be used as the basic equations for calculating the bellows, though strictly speaking they only apply to single-ply bellows with U-shaped corrugations (parallel side walls) and with a constant wall thickness over the entire corrugation. Bellows with more than one ply can be calculated approximately using these equations, providing the number of plies is not too high (between 2 and 5) and the overall wall thickness is small in relation to the given corrugation height.

### The Witzenmann method

The essential amendments and extensions of the calculation method acc. to EN 13445 introduced by us are:

- Suspension of the limit of five plies by introducing a correction factor
- Modification of the fatigue life curve based on tests
- Modification of the equation for column instability considering the influence of movement

## Service life

Based on test results and considering the correction factor, a fatigue curve specific to the manufacturer was established. The determination of this particular curve followed EN 13445-3 and EN 14917. Based on the best fit curve a S-N curve is determined, which covers at least 98 % of the test results. It is called "design curve" and is the basics for the expansion joint design (Fig. 11.2).

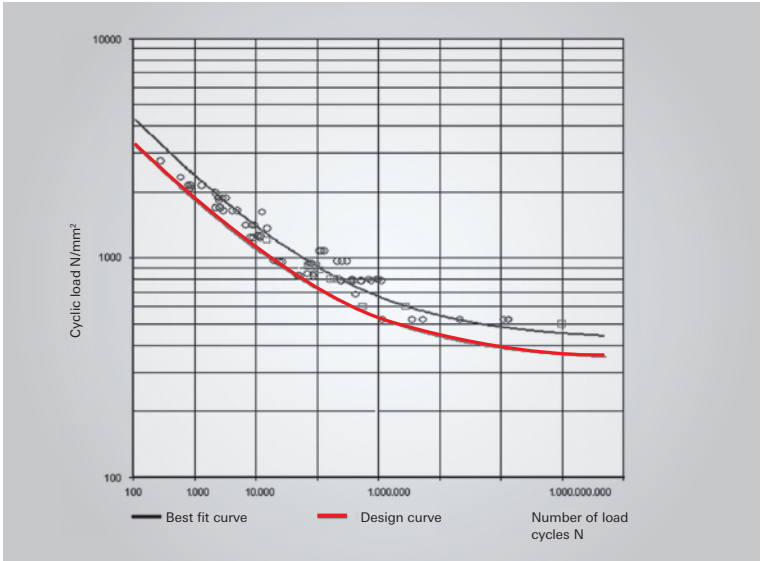


Fig. 11.2 Determining the S-N curve

### Stability

The performance of a bellows (pressure resistance, fatigue life) can be decreased considerably by instability. Therefore, a reliable calculation of the critical internal pressure is very important.

There are two kinds of instability:

Column instability, which only applies to bellows with internal pressure, is defined as a strong lateral shift of the bellows median line and occurs at bellows with a relative large ratio of length to diameter (Fig. 11.3).

To determine the critical pressure we have considered both the static pressure and the effect of movement.

In-plane instability – also called local instability – occurs at small ratio of length to diameter and is defined as moving or twisting the plane of one or several corrugations against the straight axis of the bellows (Fig. 11.4).

11



Fig. 11.3

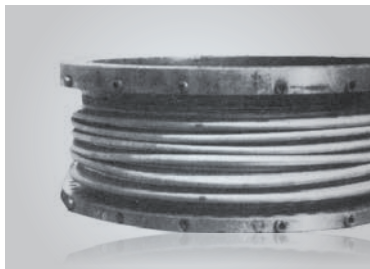


Fig. 11.4

## Spring rate of bellows

The spring rate of a bellows is no explicit, linear size. It depends on the geometry (in particular wall thickness and corrugation height) and the material of the bellows.

The stiffness of a bellows can be calculated within the elastic range with sufficient accuracy (see EN 13445-3). Strictly speaking, it is valid only for small axial movements. When the axial deflection increases (plastic range, line BC in Fig. 11.5), it deviates from the linear course.

With great efforts it is possible to determine the real working spring rate by measurement.

For this reason, we formulated an equation for the working spring rate by analysis of internal measurements in combination with theoretical models. With this equation it is possible – in accordance with the results of measurement – to calculate the working spring rate in relation to the axial movement.

All supplementary influences such as pressure, friction between the plies or partly plastic deformation were taken into account in this equation.

For large movements, high pressures or high temperatures, it is recommended to apply the effective working spring rate (AC) for the calculation. We gladly calculate it individually for your specific application.

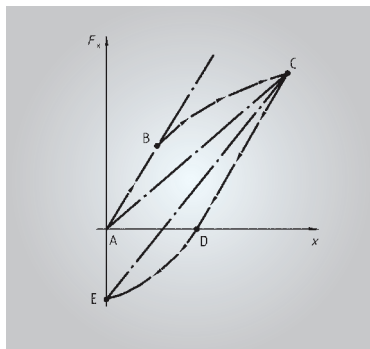


Fig. 11.5



# AXIAL PRESSURE THRUST AND PRESSURE-BALANCED DESIGNS



A longitudinal force with the magnitude  $F_L = a \cdot p$  generally prevails in a pressurized pipeline, where  $a$  represents the pipe cross-section and  $p$  the pressure difference (internal/external). The pressure thrust is generated by the axial pressure components, which act on a projected cross-section at the end of a pipe section (Fig. 12.1).

If a flexible, unrestrained, axial expansion joint is used, pressure thrust is released, i.e. there is no reaction in the pipeline in the form of a longitudinal force. The pressure thrust must be absorbed at both ends of the pipe section by means of anchors.

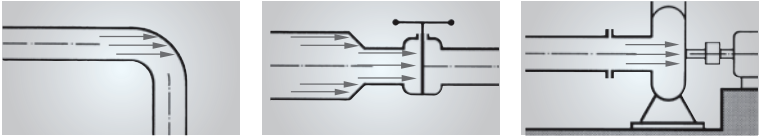


Fig. 12.1 Pipe elbow – Gate valve – Pump

Since an axial expansion joint normally has a mean bellows diameter which is larger than the inside diameter of the pipe, the force which must be taken into account when designing the anchors is slightly higher (Fig. 12.2).

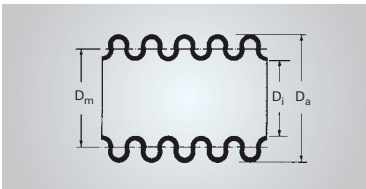


Fig. 12.2 Diameter of bellows

## AXIAL PRESSURE THRUST

$$(12.1) \quad F_p = A \cdot p$$

A = effective bellows cross-section  
p = Over pressure

The axial pressure thrust is obtained in kN, if A is specified in cm<sup>2</sup> and p in kN/cm<sup>2</sup> (1kN/cm<sup>2</sup> = 100 bar; see Chapter 4, "Compensation types", Fig. 4.3). The effective bellows cross-section specified in the dimension tables for the axial expansion joints can be well approximated with the aid of the mean bellows diameter.

### Effective bellows cross-section

$$(12.2) \quad A = \frac{\pi}{4} D_m^2$$

### Mean bellows diameter

$$(12.3) \quad D_m = \frac{1}{2} (D_i + D_a)$$

12

The maximum over pressure which occurs must be used when designing the anchors (usually the test pressure).

From the difference between the cross-sections of bellows and pipe,  $\Delta A = A - a$ , a force component results which is transmitted as a longitudinal pressure thrust from the expansion joint through the pipe to the anchor (Fig. 12.3).

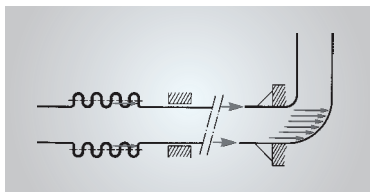


Fig. 12.3 Axial pressure thrust with axial compensation

## Restrained expansion joints

Expansion joints are fitted with restraint hardware in the form of spherically pivoted tie rods or hinges, in order to guide the longitudinal force via the expansion joint from one pipe connection to the other. Thus, a pipe with restrained expansion joints behaves like a continuous pipeline regarding axial pressure thrust and longitudinal force. Anchors and guides are not loaded by the axial pressure thrust.

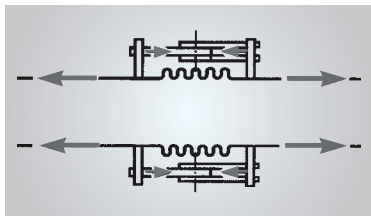


Fig. 12.4 Axial force at the angular expansion joint

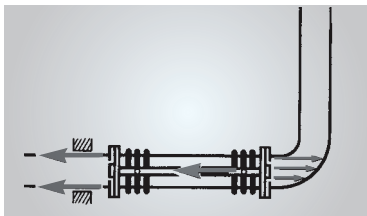


Fig. 12.5 Axial force at the lateral expansion joint

## Pipe connection load

The pressure thrust acts on machines and aggregates via the pipe connectors, whereby different pipe connection loads result depending on the type of pipe connection. **No other loads are considered here.**

**Rigid pipe connection** (Fig. 12.6)

- Longitudinal force equal to pressure thrust pulls at pipe connection (with internal over pressure)
- No load on foundation

**Connection with restrained expansion joint or pressure-balanced expansion joint** (Fig. 12.7)

- Longitudinal force equal to pressure thrust pulls at pipe connection (with internal over pressure)
- No load on foundation

**Connection with axial expansion joint** (Fig. 12.8)

- Connecting piece practically force-free
- Pressure thrust absorbed by supports

(12.4)

$$Q_A = Q_B = \frac{F_p}{2}$$

$$F_A = -F_B = F_p \frac{h}{c}$$

The problem which results when flexibly supported aggregates must be connected via axial expansion joints is apparent: the aggregate is tilted due to the applied force (see also Chapter 13).

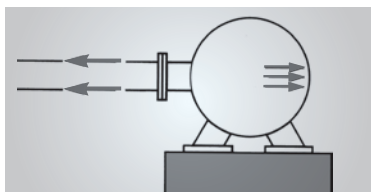


Fig. 12.6 Axial force on an aggregate with rigid pipe connection

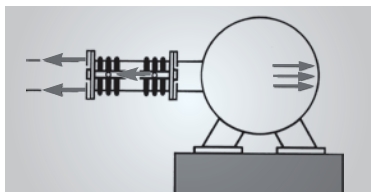


Fig. 12.7 Axial force on an aggregate with lateral expansion joint

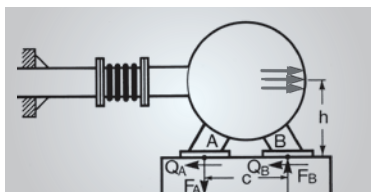


Fig. 12.8 Axial force on an aggregate with axial expansion joint

## PRESSURE BALANCED DESIGNS

Since higher operating pressures and larger diameters can cause the axial pressure thrust to reach a level which makes it either uneconomical or impossible to size the anchors, restrained expansion joints (either angular or lateral expansion joints) are normally used to absorb the thermal expansion. In such cases, they always require the pipeline to be rerouted however, since their design does not permit axial movement. If it is undesirable to reroute the pipeline, or if it is impossible for reasons of space, **straight-section tie rods** or **pressure balanced axial expansion joints** can be used instead, depending on the plant-specific conditions.

Pressure balanced axial expansion joints are relatively complex designs, which should only be used if other, more economical alternatives are not viable. One possible reason for using them might be that they are designed to absorb additional, lateral movements, e.g. vibrations.

The **elbow-connected pressure balanced expansion joint** is a versatile variant of the pressure balanced design; in contrast with the designs described above, it requires the pipeline to be rerouted, but in exchange provides flexibility on all planes.

### Straight-section tie rods

Vessels which must be connected together by a straight pipe – often at great heights – cannot absorb any significant axial pressure thrusts. An axial expansion joint and a straight-section tie rod which is adequately sized to cope with the pressure thrust may be the best answer (Fig. 12.9). The tie rods are almost always fixed and fitted by the customer. The full benefit is only obtained from the straight-section tie rod if the tie rods are located outside the insulation, in other words if they remain “cold”, and if they are fitted in the centre of the vessels.

If differences in height must be compensated at the same time, hinge-supported restraint hardware and axial expansion joints which are adequately sized to cope with the total movement are necessary.

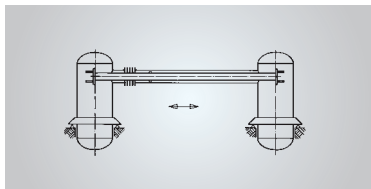


Fig. 12.9 Two containers connected together by a straight-section tie rod

## Pressure balanced axial expansion joints

These designs compensate the axial pressure thrust by an additional pressure chamber, which can be either circular or toroidal and which is connected to the two diverging ends of the working bellows in opposite directions (Figs. 12.10 to 12.13).

Pressure thrust compensated via **toroidal chamber** with cross-section corresponding to effective cross-section A of working bellows

- Three bellows necessary
- No redirection of flow

Pressure thrust compensated via **circular pressure chamber**

- Two identical bellows – in this case with pressure applied externally – permit full compensation of pressure thrust
- The flow is redirected

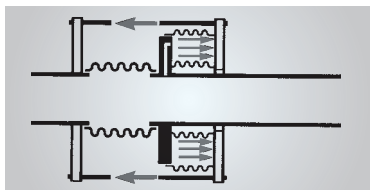


Fig. 12.10 Pressure balanced axial expansion joint.  
Toroidal chamber principle

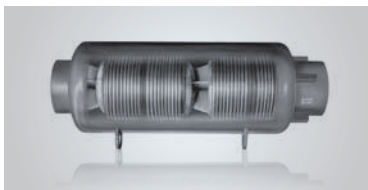


Fig. 12.11 Pressure balanced axial expansion joint.  
Pressure chamber principle

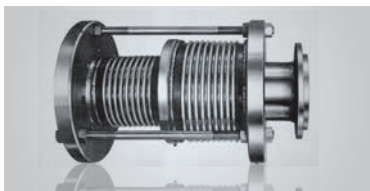


Fig. 12.12 Pressure balanced axial expansion joint,  
toroidal chamber principle, for chemical plant



Fig. 12.13 Pressure balanced axial expansion joint,  
toroidal chamber principle, in district-heating pipe  
system DN 1000



Other designs based on the same principle are also possible, and have been implemented in numerous cases. Finally, the design is dictated by the requirements of the specific application. Our multi-ply bellows designs with their low adjusting forces have proved extremely useful, since either one or two additional bellows must now be deflected in comparison to a usual axial expansion joint. The axial adjusting force cannot be compensated in the manner of the pressure thrust and remains as a load on the anchors.

### Elbow-connected pressure balanced expansion joints

This design exploits a rerouted pipeline by incorporating the expansion joint exactly at the "elbow". The axial pressure thrust is then compensated by means of an additional bellows, which is located outside the actual pipe and acts as a piston, thereby transferring its counter-force to the pipe connected via tie rods (Fig. 12.14).

The simplest type is the **elbow-connected pressure balanced axial expansion** joint with slight lateral flexibility (Fig. 12.14).

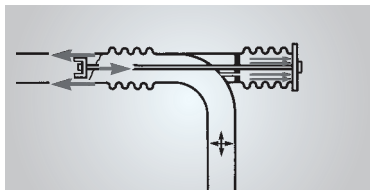


Fig. 12.14 Elbow-connected pressure balanced expansion joint (principle)

One example of how this design can be used in practice is **to connect vessels** if they perform only small vertical movements or if at larger vertical movements, the possibly staggered differential movement remains small enough. (Fig. 12.15).

Otherwise designs with greater lateral flexibility, provided by **two working bellows**, must be used instead. (Fig. 12.16).

Elbow-connected pressure balanced lateral expansion joints can also be used in 3-dimensional systems if they are fitted with **gimbal joints** for flexibility in all planes.

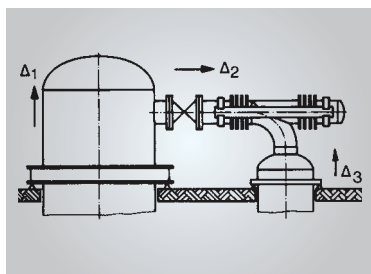


Fig. 12.15 Angle balanced axial expansion joint as vessel connection

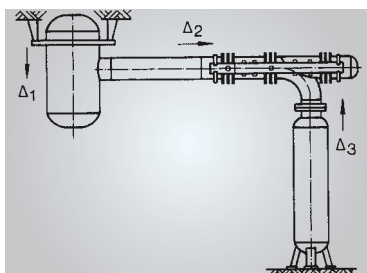
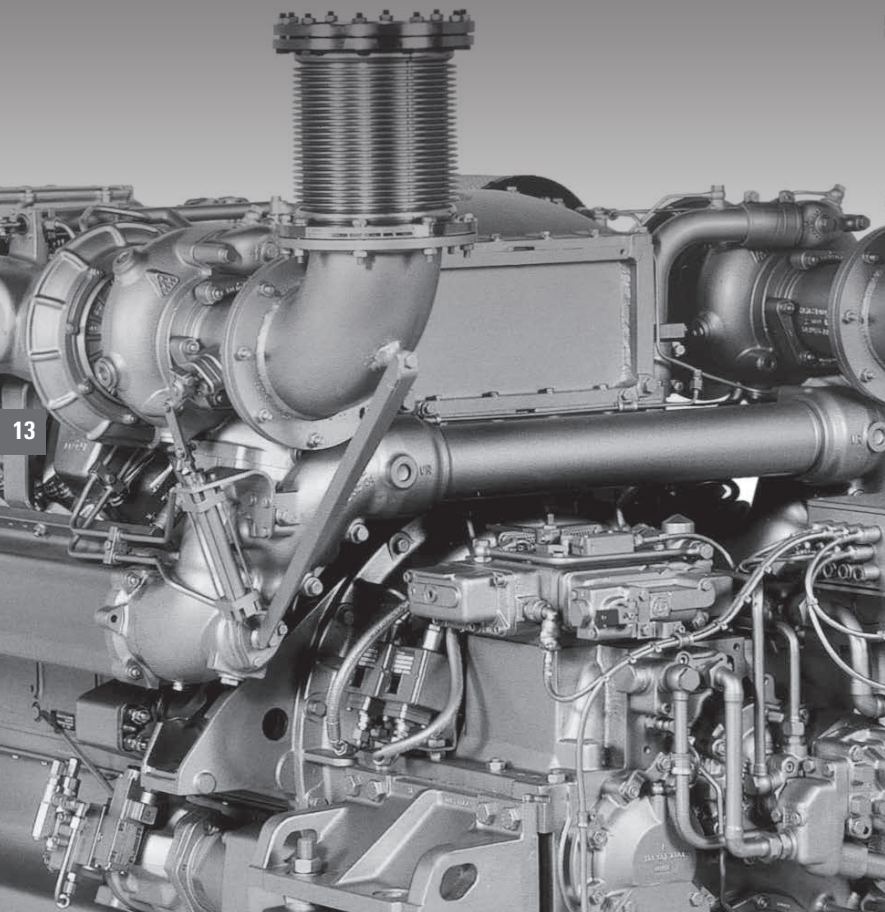


Fig. 12.16 Elbow-connected pressure balanced lateral expansion joint

# VIBRATIONS AND SOUND

Hydrodynamic machines, piston engines and similar aggregates generate vibrations with differing frequencies and amplitudes according to their construction type as a result of the rotating or to-and-fro movement of their masses.



Consequently, the pipes connected to them are also stimulated to vibrate, which can lead to material fatigue and damage. Damage is inevitable if resonance occurs in the connecting pipes. High-frequency vibrations moreover have an unpleasant side-effect in the form of noise, whilst low-frequency vibrations can be passed on via the foundations and the ground and cause damage in neighbouring constructions.

In order to prevent vibration damage and noise propagation the aggregates are flexibly supported and their connecting pipes are decoupled by means of flexible pipe elements. Metal hoses and expansion joints are used for this purpose. The most important criteria which should be considered when selecting an appropriate flexible element are as follows:

- **Dimensions of pipe connectors**
  - Drilling pattern of flanges
  - Diameter and thickness of weld ends
  - Bolting (types and dimensions)
  - Special connections
- **Operating data**
  - Pressure
  - Temperature
  - Flow velocity
  - Medium (possible impurities)
- **Permissible forces and torques**
  - acting on the pipe connection
  - acting on the entire aggregate (stability)
- **Thermal expansion, if this must also be absorbed**
- **Vibrations (sustained vibrations)**
- **Direction**
  - Amplitude
  - Frequency
- **Space available for installing flexible elements**
- **Anchors and guides for outgoing pipes**
  - (possible capabilities)

The **connections** used for vibration elements usually take the form of flanges according to EN 1092 or equivalent standards. Special flange designs are often necessary for engines due to the lack of space available.

The nominal pressure of the flexible pipe element can be determined from the **operating data** (pressure and temperature), taking the reduction factor into account. This data also effects the choice of materials for the corrugated section and for the connection parts (see Chapter 5, "Selecting an expansion joint").

The operating pressure is used additionally to calculate the axial pressure thrust which acts as a longitudinal force in all pressurized pipes. This force is released if an axial expansion joint is used, thereby placing a direct load both on the next support and on the aggregate (Fig. 13.1). This topic is discussed in more detail in Chapter 12, "Axial pressure thrust and pressure balanced designs".

It should be noted that the released **axial pressure thrust** acts on the interior wall of the housing which is opposite the pipe connector (Fig. 13.2), and that the flexibly supported aggregate may be tilted or displaced excessively, depending on the magnitude of the force. Since it determines the direction of the force and thus also its permissible magnitude, the position of the pipe connector is also important in addition to the weight of the machine and the elastic parameters of the support.

13

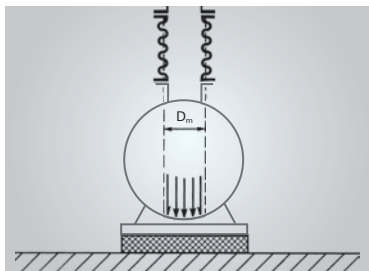


Fig. 13.1 Axial pressure thrust acting vertically on an aggregate

If lateral forces occur, the permissible **connector loads** should always be checked, especially if lateral expansion joints, which can only move in lateral direction, are installed. HYDRA lateral expansion joints with multi-ply bellows have relatively small lateral adjusting-force rates; however these rates may be too high for types designed for high operating pressures, due to friction, or very short total length, especially if thermal expansion must also be absorbed.

The medium which is conveyed also has an influence on the choice of materials if it is aggressive or contains aggressive components (see Chapter 5, "Selection of Expansion Joints").

Significant vibrations with amplitudes of 0.1 – 0.5 mm are generated primarily at piston engines due to the to-and-fro movement of their masses. Turbines, centrifugal pumps and turbo-compressors usually only generate vibrations with very small amplitudes –often in the audible frequency range –which are due to unbalance or to pressure differences at the blades.

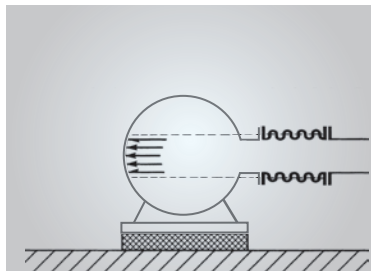


Fig. 13.2 Axial pressure thrust acting horizontally on an aggregate

In all machines the highest amplitudes are thus encountered in a plane which is perpendicular to the rotation axis. The requirements which must be met by the flexible elements, and on which the choice must be based, can therefore differ considerably according to the position of the pipe connections.

In addition to the vibration values during continuous operation, which necessitate highly durable elements, movement amplitudes which are often up to five times as high are likely during start-up, especially if the machine must pass through a critical speed range. These larger movements can generally be ignored when designing the flexible elements, since they are only allowed to occur for extremely short periods in the interests of gentle machine operation.

The first natural frequencies of the flexible elements should be higher than the excitation frequencies of the machine and sufficiently far away from them.

The elements used for **sound insulating**, on the other hand, must have natural frequencies that are lower than the acoustic frequency, which is almost bound to be the case. Such elements can only provide insulation against structure-borne noise. Any noise conveyed in the medium (e.g. water) is normally not dampened to any significant extent by flexible connecting elements.

Braided HYDRA metal hoses and multi-ply HYDRA expansion joints, with their special design principle, have a sound insulating effect, which has been verified by means of tests. The multi-ply HYDRA axial expansion joints, for example, can provide insulation against structure-borne noise up to 20 dB. Thus, they are far superior to single-ply designs.

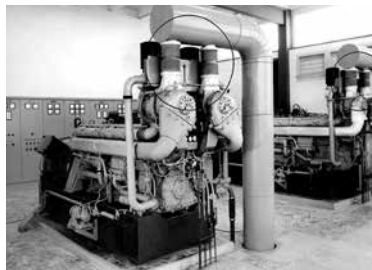
13

Pressure impulses in the medium, which may also deform the pipes or cause them to vibrate, cannot be eliminated using flexible elements. Viscous dampers must be used instead.

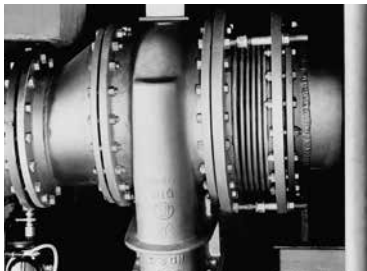
# FLEXIBLE ELEMENTS FOR ABSORBING VIBRATIONS

Every all-metal flexible pipe element we supply for connecting to vibrating aggregates is pressure and temperature-resistant and absolutely leakproof. Our elements do not age, and if chosen and fitted correctly, have a practically unlimited service life.

Different types of flexible elements can be used, depending on specific requirements (Figs. 13.3 and 13.4). The table below lists the various possible designs and outlines the applications to which they are best suited for (Fig. 13.5). Differentiated evaluation of the individual case may allow deviations from the given reference values.




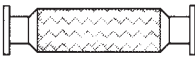

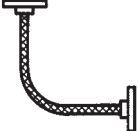
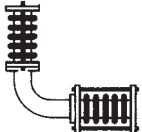

*Fig. 13.3 Axial expansion joints used on superchargers of diesel engines*









*Fig. 13.4 Axial expansion joints used at pumps.*



# SUMMARY

Number	Flexible element	
1		Axial expansion joint
2		Lateral expansion joints with braiding as restraint
3		Lateral expansion joints with elastically supported tie rods (wire mesh cushions)
4		Metal hose with 90° bend (See Metal Hose Manual No. 1301)
5		Lateral expansion joints with tie rods in 90° angular configuration
6		Elbow-connected balanced expansion joint (Special design on request)

Values higher than the approx. values are also possible

	Approx. movement values	Nominal diameters DN	Pressure rating PN (max)
	 <p>All planes</p>	<p>15 – 100 150 – 1000 ≥ 1000</p>	<p>≤ 2.5 ≤ 1 unpressurized</p>
	 <p>Noise in all directions in circular plane</p>	<p>15 – 40</p>	<p>25</p>
	 <p>Noise in all directions in circular plane</p>	<p>50 – 500</p>	<p>25</p>
	 <p>All planes</p>	<p>≤ 100</p>	<p>25</p>
	 <p>All planes</p>	<p>50 – 500</p>	<p>63</p>
	 <p>All planes</p>	<p>50 – 500</p>	<p>63</p>

## AXIAL EXPANSION JOINTS

The most economical element with the simplest design is the axial expansion joint. It can be used whenever the aggregate is able to withstand the axial pressure thrust specified in the table below for a common range (Fig. 13.6).

Nominal pressure PN	Nominal diameter DN						
	50	65	80	100	125	150	200
1	450	700	900	1350	2000	2800	4500
2.5	1100	1700	2200	3800	5000	7000	11200
6	2700	4100	5300	8100	12100	16750	66900
10	4500	6800	8800	13500	20100	27900	44800

Fig. 13.6

Axial pressure thrust in N: Values for larger dimensions and higher pressures are specified in the graph (Fig. 4.3) in Chapter 4, "Compensation types"

### Vibration amplitude

The permissible vibration amplitude can be calculated from the axial movement:

#### Axial vibration amplitude

$$(13.1) \quad \hat{a}_\delta = 0.03 \cdot 2\delta$$

Axial movement at temperature  $2\delta$  in mm ( $2\delta = K_{\Delta\theta} \cdot 2\delta_N$ )

#### Lateral vibration amplitude (one bellows)

$$(13.2) \quad \hat{a}_x = 0.01 \frac{l}{D_a} \cdot 2\delta$$

Corrugated length of bellows  $l$  in mm, outside diameter of bellows  $D_a$  in mm

The equations yield the maximum values for vibrations in one direction. Proportional values are permissible for vibrations in all planes.

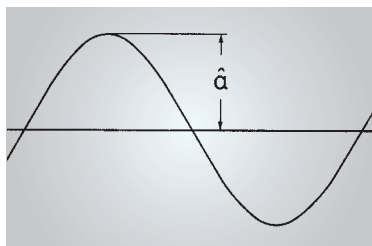


Fig. 13.7 Sinusoidal vibration

### Thermal expansion

If thermal expansion must be absorbed in addition, the permissible values can be calculated in the usual way (see Chapter 5, "Selecting an expansion joint"), i.e. sustained vibrations need not be taken into account. This also applies to lateral movement, which can be calculated for axial expansion joints with single bellows according to the equation below:

### Equivalent lateral movement

$$(13.3) \quad 2\lambda = 2\delta \cdot \frac{1}{3} \cdot \frac{l}{D_a}$$

### Lateral spring rate

$$(13.4) \quad c_\lambda = 1.5 c_0 \left(\frac{D_a}{l}\right)^2$$

Axial spring rate  $c_0$  in N/mm (taken from dimension tables for axial expansion joints).

The expected pipe connection load can be determined on the basis of the spring rate (see Chapter 9, "Installation of expansion joints").

### Guides and anchors

The diverting pipes of vibrating aggregates, which are decoupled by means of axial expansion joints, must be supported directly downstream of the expansion joint, whereby it is important for the fixture to be independent of the vibrating foundation. A support in the form of a fixed or sliding anchor must be sized so that it is capable of absorbing the axial pressure thrust in addition to the adjusting forces (Fig. 13.8). A sliding anchor should be used if lateral thermal expansions must be absorbed at the same time (Fig. 13.9).

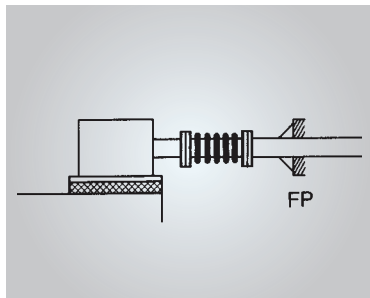


Fig. 13.8 Axial expansion joint at a vibrating aggregate, anchor

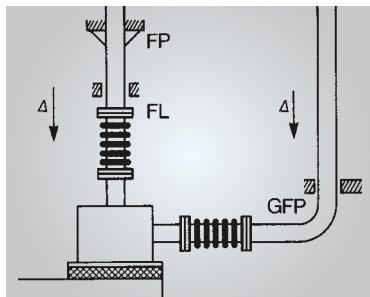


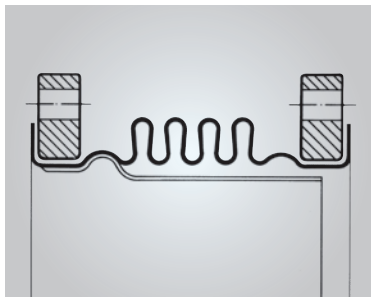
Fig. 13.9 Axial expansion joints at a vibrating aggregate, guides and anchors

### Natural frequencies

The natural frequencies in the axial and radial directions are specified for the standard range of "axial expansion joints for low pressure". They only apply if the expansion joints are used for gaseous media. If other axial expansion joints are to be used to absorb vibrations, the calculation of the natural frequency must take into account whether a gas or liquid is to pass through the expansion joint, since this frequency also depends on the conveyed medium. We can calculate the natural frequencies for you on request.

### Internal sleeve

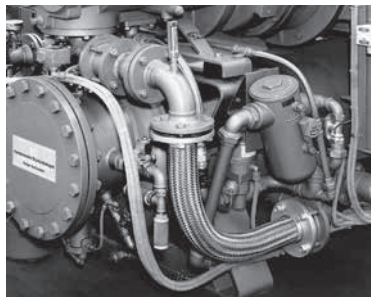
The standard design of inner sleeves is not suitable for use in vibrating expansion joints, since they impede the lateral movement. If inner sleeves are necessary, e.g. in conjunction with high flow velocities (see Chapter 5, "Selection of Expansion Joints") or abrasive impurities in the flowing medium, specially designed expansion joints can be supplied with monolithic inner sleeves with a reduced diameter (Fig. 13.10).



*Fig. 13.10 Axial expansion joint with monolithic inner sleeve with reduced diameter*

## METAL HOSES

If the nominal diameters are sufficiently small at high pressures, i.e. up to approx. DN 100, braided metal hoses, where the braid absorbs the pressure thrust, provide a potential means of absorbing vibrations. If they are integrated in a 90° bend, they can absorb vibrations in all planes whilst producing only small adjusting forces.



*Fig. 13.11 Metal hose in 90° bend at a screw-type compressor*

## LATERAL-EXPANSION JOINTS

Lateral expansion joints are used at vibrating aggregates if the operating pressures are so high that an axial expansion joint can no longer be used due to the axial pressure thrust and a metal hose is no longer suitable because of the specified connection diameter or other parameters. If the vibrations only occur in one plane perpendicular to the axis of the pipe connector, a single expansion joint is sufficient, which has to be flexible in all directions in this plane. A design with spherically pivoted tie rods is suitable (Fig. 13.12 and 13.13).

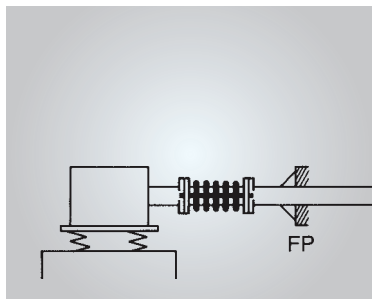


Fig. 13.12 Lateral expansion joint at vibrating aggregate

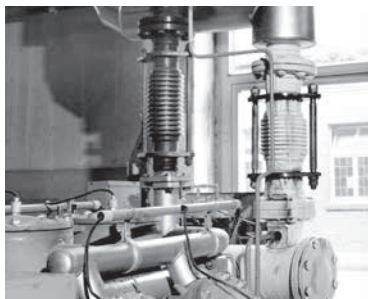


Fig. 13.13 Lateral expansion joints with tie rods at vibrating aggregate

If 3-dimensional movements occur in all directions, a second expansion joint must be installed perpendicular to the first. The additional expansion joint should be either an angular expansion joint (Fig. 13.14) or a lateral expansion joint (Fig. 13.15), depending on the magnitude of the vibration amplitudes and on potential thermal expansion which must be absorbed. If an angular expansion joint is used, it must be installed so that it can work together with the lateral expansion joint, i.e. the pipe bend must be able to execute tilting movements, and the lateral expansion joint must be designed to permit tilting movements at the associated flange.

If a second lateral expansion joint is used as the additional joint, the restraint hardware of the two expansion joints must be arranged at 90° against each other (Fig. 13.15).

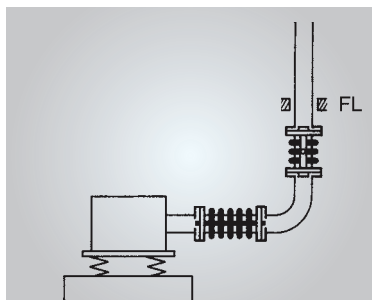


Fig. 13.14 Lateral and angular expansion joints at vibrating aggregate

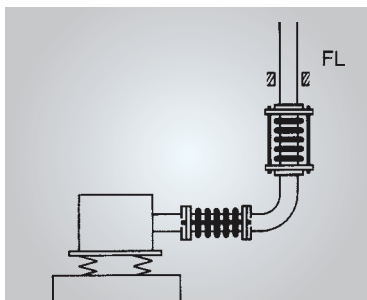


Fig. 13.15 Lateral expansion joints at vibrating aggregate



## ELBOW-CONNECTED PRESSURE BALANCED EXPANSION JOINTS

Where appropriate elbow-connected pressure balanced expansion joints may be the best answer, since they can effect 3-dimensional vibrations in all planes with a small vibrating mass (Fig. 13.16).

This adapted special design is generally somewhat more expensive than the arrangement shown in Fig. 13.15.

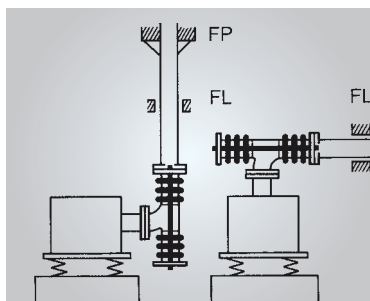


Fig. 13.16 Elbow-connected pressure balanced expansion joints at vibrating aggregate

## SOUND INSULATING EXPANSION JOINTS

If lateral expansion joints must be used on account of the operating conditions as described above, the insulation does not necessarily prevent transmission of structure-borne noise, since the restraint hardware still transmits the sound despite the use of multi-ply bellows.

For small nominal diameters lateral expansion joints with braiding as restraint (Fig. 13.17) can be used, for large diameters specially developed HYDRA lateral expansion joints (LBS and LRS types); with sound insulating pivoted tie rods which ensure that the machine connection has the necessary noise isolation. The insulating cushions made of stainless-steel wire mesh which are used to support the tie rods are resistant to ageing and temperature, and are therefore able to maintain their technical characteristics almost entirely throughout the operating time, even at high temperatures (Fig. 13.18).

The permissible vibration amplitude for sustained vibrations is approximately 5 % of the movement values in one plane specified in the dimension tables for 1000 load cycles ( $\delta$ ,  $\alpha$ ,  $\lambda$ ) for all expansion joints.

The flexible element should always be assembled as close as possible to the vibrating aggregate in order to prevent additional movements.

***An anchor or a guide support, which is independent of the vibration bed, should be installed directly after the compensating element in order to reduce the free-swinging mass to a minimum. This largely prevents the risk of self oscillation.***

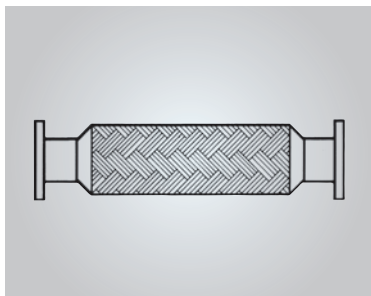


Fig. 13.17 Lateral expansion joints with small nominal diameters with braiding for absorbing vibrations (sound insulated)

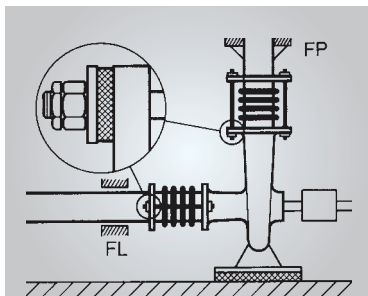
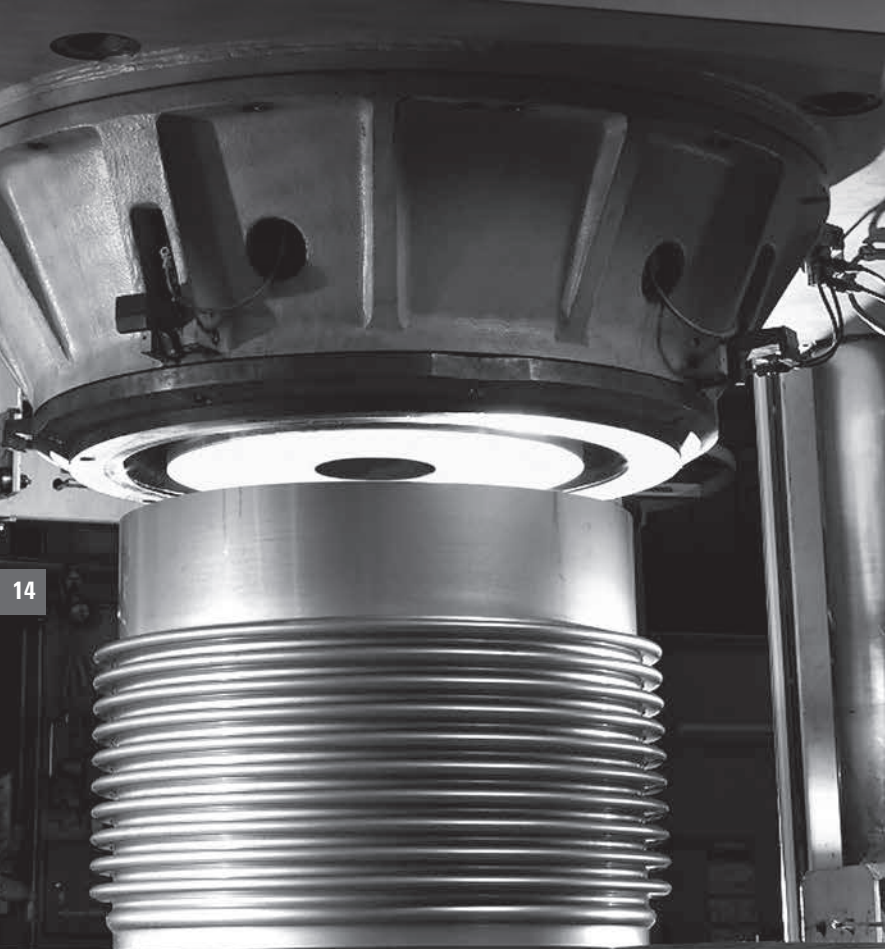


Fig. 13.18 Lateral expansion joints (sound insulating)

# MANUFACTURING AND TESTING

Expansion joint manufacturing necessitates a mastery of two crucial procedures - bellows forming and welding engineering.



# MANUFACTURING

## Bellows forming

The bellows manufacturing process starts with the production of single or multi-ply cylinders, or cylinder packages using a readily formable material, predominantly austenitic stainless steel 1.4541.

To this end thin strips (0.3 to 2 mm) or sheets are firstly cut, then formed to a pre-rounded cylinder and in the last step longitudinal seam welded into a single cylinder. Multi-ply bellows are manufactured from several individual cylinders inserted into each other (cylinder packages)(Fig. 14.1).

During the forming of the cylinders or cylinder packages into bellows, circular corrugations are formed. The used forming procedures can be categorized into two basic procedures. Depending on the bellows geometry and the Nominal diameter either hydraulic or mechanical forming is used.

The hydraulic method applies a special forming emulsion under high pressure from the inside to a cylinder section which is divided up by means of external and internal tools. A corrugation is produced when the cylindrical section is formed in the circumferential direction as a result of the internal pressure. The material undergoes only the geometrical changes in the process and requires no follow-up treatment. This method is very gentle on the material.



Fig. 14.1 Cylinder packages

Elastomer forming is a variation of the hydraulic bellows-forming method, whereby the elastomer pad performs the task of the hydraulic fluid. The pad is pressed outwards by a movable tool, thereby forming the corrugation, which is then final-formed by recompression. This method is especially suitable for thick walls, and is used up to DN 1200. Automatic Presses with capacities up to 1000 tons are available.

Types of mechanical methods are roll forming and punching. Both are used primarily for medium and large diameter. For roll forming, several roll forming tools simultaneously form the bellows in a single process. For punching, corrugation after corrugation is radially shaped with segment tools. All bellows for expansion joints produced by Witzenmann are formed automatically. Circumferential weld seams on the corrugations are not necessary.

Beside the mentioned austenitic stainless steel 1.4541 other sufficiently formable materials, for which we have accumulated comprehensive know-how, can also be used to manufacture bellows, if the application so demands.

### **Welding engineering**

Welding engineering is just as crucial to us as bellows forming. The above-mentioned longitudinal seam of the cylinder, which must survive the forming process without damage, is particularly important, together with the connection weld seam, which must join the bellows and the connection parts together pressure-tight. The nature of the connection weld seams differs according to the expansion joint design, the dimensions and the combination of materials. It is essential for the connection seam to be designed so that the expansion joint remains absolutely leakproof throughout its long operating time. The most suitable economic method should always be used to make weld seams. Methods such as Laser, TIG, MIG, MAG and submerged-arc welding, which are automated to a large extent, are also employed. These methods have been well tried and tested and are comprehensively backed up by welding procedures. Welding work is always performed by qualified welders based on predefined parameters. We apply the same care to the other weld seams, e.g. at the restraint hardware of the hinged expansion joints, some of which are located in the force flow and are therefore required to be of a correspondingly high quality.

# INSPECTING AND MONITORING

Inspections are carried out to back up the quality of our expansion joints, parallel to the manufacturing process and independently of the manufacturing personnel. The most important test steps and inspections which we perform in standard cases are described below.

## Standard incoming inspections

Strip and sheet metal material are subjected to an incoming inspection when they arrive at our factory, whose scope may differ according to the intended application. We check whether the requirements set out in our order specifications have been met.

- Certification
- Marking
- Material analysis
- Physical material values
- Dimensions / tolerances
- Surface finish

Accordingly the strip material is documented by an official inspection certificate according to EN 10204 - 3.1.

## Production monitoring

The production process is constantly monitored by the company supervisory staff. In addition, the following random checks are performed by the quality department:

- Valid work instructions at workplace
- Up-to-date forming parameters for bellows production
- Valid welding parameters for longitudinal cylinder weld seams and connection seams
- Correct welding fillers
- Preheating temperatures
- Dimensional accuracy of components and assemblies

If any special requirements must be met, accompanying inspections may be performed by the quality department parallel to the manufacturing process.

## Standard final inspections

The final inspections described below are performed for the finished expansion joints before they are delivered. These can be considered as part of the production process and do not entail any additional costs. They are documented internally.

Certification for these inspections can be provided in return for a refund of the purchase price if this is agreed when the order is placed.

## Leak test

All expansion joints are usually tested for leaktightness. Different methods are used depending on the construction type, size and application of the expansion joint.

### ■ Nitrogen under water

The expansion joint is clamped in a test tank between two sealing plates and filled with nitrogen, pressure 2-4 bar. The tank is then flooded with water. After a suitably defined hold time, bubbling must not be detected (leakage rate less than  $10^{-3}$  mbar l/s).

### ■ He sniffing method

A gas mixture comprising nitrogen and helium is applied to the sealed, clamped expansion joint (pressure approx. 2 bar), and it is sniffed at all critical points with an He sensor (leakage rate less than  $10^{-5}$  mbar l/s).

### ■ Helium leakage test under vacuum

As a special inspection a Helium leakage test can be performed if required. The expansion joint is vacuumed from the inside and is exposed with Helium atmosphere from the outside. Helium can diffuse through smallest leakages to the inside and can be detected (Leakage less than  $10^{-9}$  mbar l/s)

## Pressure test

Expansion joints are subjected to a pressure test in a test press if required. The test pressure is calculated according to the following formula in Chapter 5 "Selection of Expansion Joints" as specified in the official regulations.

$$(5.11) \quad P_T = \max \begin{cases} 1.25 \cdot PS \cdot \frac{f_0}{f} \\ 1.43 \cdot PS \end{cases}$$

To reduce the axial forces in case of greater dimensions and higher pressures a stable inner pipe is clamped pressure-tight during the pressure test. If the available standard testing facilities are inadequate due to an extremely high pressure thrust, we recommend performing the pressure test for the expansion joint together with that of the plant. The expansion joint must not have any leaks or deformations which could give rise to doubts regarding safety.

## Dimensional check

This checks the dimensional accuracy, in particular with regard to the installation and connection dimensions.

## Visual inspection

This checks for visible defects or damage, especially to the corrugations of the bellows.

Tests and inspections, including the associated documentation, over and above the scope of those described here are possible. The necessary facilities are available. The scope of the tests should always be the subject of very careful thought and restricted to the necessary minimum for the particular application, since the costs of such tests may be extremely high and may easily exceed the value of the expansion joint.



# MARKING, CORROSION PROTECTION, PACKAGING



# MARKING

Our expansion joints are usually supplied with a permanent identification plate made of stainless steel, which contains the following information as a minimum:

- Witzenmann
- Pforzheim
- Serial number
- Type, PN, DN, movement
- Year of production

Expansion joints without connection parts (compensation bellows) are supplied with a sticker, tag or other marking instead of an identification plate.

Flanges and weld ends are marked separately, the data being embossed:

- **Flange**  
DN / PN / material / manufacturer's identification mark
- **Weld ends**  
DN / material / manufacturer's identification mark

Expansion joints in the low-pressure series do not normally have any identification plates and their flanges and weld ends are not marked. In the case of expansion joints requiring approval, the used parts and expansion joints are marked (identification plates) as agreed in the specification. Pretensioners and transportation fixtures, which must be removed after the expansion joint has been installed, are specially marked (indicated by additional stickers in a contrasting colour).

# CORROSION PROTECTION

## Standard designs

The bellows of our expansion joints, with the exception of a few special designs, are made exclusively of corrosion-resistant steels, mainly of austenitic stainless steel 1.4541 and do not normally require any type of corrosion protection.

The same applies to connection parts made of stainless steel. The ferrite steel parts of the expansion joints, such as flanges and restraint hardware (not weld ends) are protected externally with an anti-rust coating for transportation and short-term storage on the building site. Weld ends are either likewise painted or spray-oiled, depending on the construction type of the expansion joint. If they are painted, the welded area is masked. All ferrite steel parts are oiled from the inside where possible.

## Custom-built designs

For special applications, or if requested by the customer the corrosion protection of the steel sections can be extended by agreement. Either a special paint, a plastic coating or galvanization may be used.

# PACKAGING

## Standard packaging

Unless otherwise agreed, the expansion joints are supplied with shock-proof packaging, in a box on a pallet or clamped on a pallet, depending on their size and weight. Only hinged expansion joints, whose bellows are protected by a cover, are normally clamped directly on pallets. The bellows protection, comprising corrugated cardboard and sheet metal, prevents damage from minor shocks and weld splatters. Large expansion joints are packed depending on the transportation route.

## Transportation Fixtures

If, because of heavy connection parts, it is necessary transportation fixtures are attached, which maintain the size and form of the expansion joints and prevent them from vibrating during transportation. If metal parts are welded or bolted on for this purpose, they are identified by means of separate paint. These must be removed after installation.

## Special packaging

Special packaging can be provided after arrangement either by Witzenmann or by specialised subcontractors instructed by us.

# INSTALLATION INSTRUCTIONS



# INSTRUCTIONS FOR THE INSTALLATION OF WITZENMANN EXPANSION JOINTS WITH FIXED OR LOOSE FLANGES

HYDRA expansion joints are maintenance-free. They are designed exclusively for the agreed conditions specified in the order. Long-term reliable operation is only guaranteed when they are properly incorporated and installed in systems and when they can operate without being damaged or hindered. See also „Installation of expansion joints“ in our manual.

**Note:** even restrained expansion joints can slightly expand or shorten elastically as a result of pressure thrust. This does not limit their function, as in a multi-hinge system the change in length can be absorbed by pipe bending or other expansion joints. Witzemann can provide further information if necessary.

## General installation instructions

- Check the expansion joint for any damage before installation.
- Handle the expansion joint with care – no harsh knocks or impacts – do not throw
- Do not attach chains or ropes to the bellows
- Protect the bellows against weld spatter and abrasion – cover with non-conductive material
- Prevent an electrical short-circuit by welding electrodes, earthing cables, etc. – the bellows may suffer irreparable damage
- Keep the bellows corrugations inside and outside free from foreign matter (dirt, cement, insulation material) – check before and after installation
- Before insulating with mineral wool, cover with sheet metal all around
- Do not use any insulation material
- containing corrosive substances
- Avoid excessive movements and torsion (twisting) at all, during installation and operation (Figure 16.1)

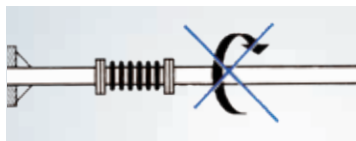


Fig. 16.1 Pipe with axial expansion joint

## Installation Instructions

- Remove the marked pretensioning bracket and transport fixtures after installation – not before
- Before start-up, remove any protection and packaging materials, such as cardboard packaging, tape or plastic foil, which are not explicitly shown as being part of the expansion joint
- Make sure that the fixed points at the ends of pipeline sections containing an expansion joint are of adequate size. These must be able to withstand not only the axial pressure thrust (in unrestrained expansion joints), but also the adjustment force of the expansion joint and the friction forces of the pipe guides and supports - in particular the axial pressure thrust can be very large (Fig. 16.2).

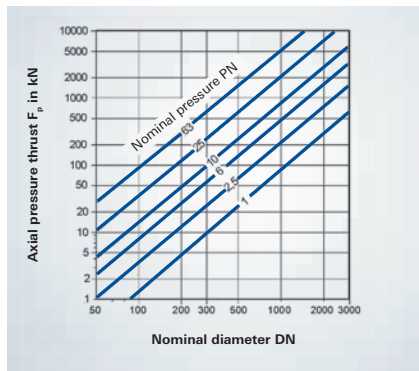


Fig. 16.2 Axial pressure thrust in a pipe with axial expansion joints

- Preload axial expansion joints and hinge systems after installation (when necessary and when agreed with Witzemann) – usually 50 % of total movement – taking into account the direction of movement and the temperature during installation
- Before pressurising the pipeline, check that flange connections, guides, fixed and loose bearings have been installed correctly and are functioning properly
- A pressure test outside the system or a pressure test on expansion joints sealed with blind flanges is only permitted after consultation with Witzemann
- The permissible test pressure and permissible deflection must not be exceeded under any circumstances

- Consider flow direction in expansion joints with internal sleeves
- After the pressure test remove liquid residues in the corrugations if necessary - these can lead to corrosion or steam explosions when increasing temperature rapidly

### Installation instructions for axial and universal expansion joints

- Install only one axial expansion joint between two fixed points
- If several axial expansion joints are installed in a straight pipe section, subdivide the section by using (light) intermediate anchors
- Pipes with axial expansion joints must be guided. Guides are required on both sides of the axial expansion joint; a fixed point fulfils the guiding function. (See Fig. 16.3 and Fig. 16.4 and related codes for maximum distances)



Fig. 16.3 Guide spacing of pipelines with axial expansion joints

- The incoming ends of the pipeline must be aligned at the position where the expansion joint is to be installed. Compensation of assembly tolerances by expansion joint deflection is only permitted after consultation with Witzenmann.
- When connected to vibrating equipment, secure the pipeline directly after the expansion joint

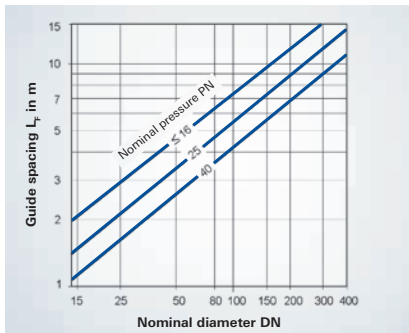


Fig. 16.4 Recommended spacing for pipe guides in pipelines with axial expansion joints



## Installation instructions for restrained expansion joints

- Provide suitable pipe guides or supports close to the expansion joint system – take lateral movements in the pipes into account
- Make sure the rotation axes are correctly oriented during installation: parallel to each other and perpendicular to the direction of movement
- Make sure the orientation of the tie rods is appropriate for the function when installing lateral expansion joints (see „Installation of expansion joints“ in our manual!)
- The factory settings of tie rods with nuts must not be changed
- The weight of the pipeline must not be absorbed by expansion joints – no sagging pipes, no additional loads on the restraint hardware

## General installation instructions

- Upon installing expansion joints with flanged connections it is essential to use the proper bolt torque when tightening the flange connection. Applying the proper torque will prevent the flanges from being subjected to critical stresses and at the same time guarantee the tightness of the flanged connection. Several national and international standards provide calculation schemes in order to obtain the proper bolt torque, which is a function of flange geometry, gasket properties and bolt tightening method.

## Bolt tightening

- Calculate proper bolt torque acc. to appropriate standard
- Tighten the bolts in a „criss-cross“ sequence using the bolt tightening method that was taken into account in the calculation of the bolt torque

## Installation of loose flanges

- For expansion joints with loose flanges, the bellows tangent is bended around the flange to form a rim. For technical reasons, there may be a small gap between the bended tangent and the flange, which however will neither compromise function nor tightness of the flanged connection. The elastic tangent will exert a uniform contact pressure on the gasket, pushing it against the counter flange. During bolt tightening, any remaining gap between the tangent and flange will vanish.

- For technical reasons, the sealing ridge diameter of expansion joints with loose flanges is limited and might therefore deviate from sealing ridge diameters as given in national or international standards for flanged connections. Accordingly, a standard gasket might overlap the sealing ridge diameter of the expansion joint. This is non-critical, even if the sharp-edged bellows tangent damages the rim of the gasket (only the inner part of the gasket is essential for the sealing effect). Cutting or grinding of the bellows tangent must be omitted in order to guarantee the function of the sealing surface.

## **Gasket**

- Gaskets need to be replaced after each disassembly

# MATERIALS



In chapter 17 you find the basic characteristics and properties of the materials used. Apart from the respective delivery form, this includes the limiting temperatures as well as strength values at ambient temperature.

The chemical composition of the materials as well as their strength at elevated temperatures are described afterwards. Finally, you will find a list of the material descriptions according to international specifications.

All information is supplied without guarantee.

# DESIGNATION, FORMS OF DELIVERY, LIMITING TEMPERATURES

Material group	Material no. according to DIN EN 10027	Steel name according to DIN EN 10027	Steel name according to DIN (old)	Semi-finished	Documentation	Upper limiting temperature
						°C
Non-alloy steel	1.0254	P235TR1	St 37.0	Welded tubes	DIN EN 10217-1	300
				seamless tubes	DIN EN 10216-1	
	1.0255	P235TR2	St 37.4	Welded tubes	DIN EN 10217-1	300
seamless tubes				DIN EN 10216-1		
	1.0427	C22G1	C 22.3	Flange	VdTÜV-WB 364	350
General construction steel	1.0038	S235JRG2	RSt 37-2	Steel bars, flat products, wire rod profiles	DIN EN 10025 AD W1	300
	1.0050	E295	St 50-2			
	1.0570	S355J2G3	St 52-3			
Heat resisting non-alloy steel	1.0460	C22G2	C 22.8	Flange	VdTÜV-WB 350	450
Heat-resisting steel	1.0345	P235GH	HI	Sheet metal	DIN EN 10028-2	480
				Seamless tube	DIN EN 10216	450
	1.0425	P265GH	HI1	Sheet metal	DIN EN 10028-2	480
	1.0481	P295GH	17 Mn 4	Sheet metal	DIN EN 10028-2	500
	1.5415	16Mo3	15 Mo 3	Sheet metal	DIN EN 10028-2	530
				Seamless tube	DIN EN 10216-2	
	1.7335	13CrMo4-5	13CrMo4-4	Sheet metal	DIN EN 10028-2	570
				Seamless tube	DIN EN 10216-2	
	1.7380	10CrMo9-10	10 CrMo 9 10	Sheet metal	DIN EN 10028-2	600
Seamless tube				DIN EN 10216-2		
Fine grain construction steel						
Normal	1.0562	P355N	StE 355	Sheet metal, metal strip, Steel bars	DIN EN 10028-3	
Heat resisting	1.0565	P355NH	WStE 355			400
Tough when cold	1.0566	P355NL1	TStE 355			(-50) <sup>1)</sup>
Special	1.1106	P355NL2	ESStE 355			(-60) <sup>1)</sup>

<sup>1)</sup> Lower limiting temperature

# STRENGTH VALUES AT AMBIENT TEMPERATURE (MINIMUM VALUES <sup>2)</sup>)

Material no. according to DIN EN 10027	Yield strength min.	Tensile strength	Elongation at break min.		Impact work min. KV <sup>3)</sup>	Remarks
	R <sub>eH</sub>	R <sub>m</sub>	A <sub>5</sub>	A <sub>80</sub>		
	MPa	MPa	%	%	J	
1.0254	235	360 - 500	23			s ≤ 16
1.0255	235	360 - 500	23		at 0 °C: 27	s ≤ 16
1.0427	240	410 - 540	20 (transverse)		at 20 °C: 31	s ≤ 70
1.0038	235	340 - 470	21 - 26 <sup>4)</sup>	17 - 21 <sup>4)</sup>	at 20 °C: 27	3 ≤ s ≤ 100 (R <sub>m</sub> )
1.0050	295	470 - 610	16 - 20 <sup>4)</sup>	12 - 16 <sup>4)</sup>		10 ≤ s ≤ 150 (KV)
1.0570	355	490 - 630	18 - 22 <sup>4)</sup>	14 - 18 <sup>4)</sup>	at -20 °C: 27	s < 16 (R <sub>eH</sub> )
1.0460	240	410 - 540	20		at 20 °C: 31	s ≤ 70
1.0345	235	360-480	25		at 0 °C: 27	s ≤ 16
	235	360-500	23		at 0 °C: 27	s ≤ 16
1.0425	265	410-530	23		at 0 °C: 27	s ≤ 16
1.0481	295	460-580	22		at 0 °C: 27	s ≤ 16
1.5415	275	440 - 590	22		at 20 °C: 31	s ≤ 16
	280	450 - 600	20		at 20 °C: 27	
1.7335	300	440 - 600	20		at 20 °C: 31	s ≤ 16
	290	440 - 590			at 20 °C: 27	
1.7380	310	480 - 630	18		at 20 °C: 31	s ≤ 16
	280		20		at 20 °C: 27	
1.0562	355	490-630	22		at 0 °C: 47	s ≤ 16
1.0565					at 0 °C: 47	s ≤ 16
1.0566					at 0 °C: 55	s ≤ 16
1.1106					at 0 °C: 90	s ≤ 16

<sup>2)</sup> Smallest value from lateral and transverse test piece

<sup>3)</sup> according to DIN EN 10045; average of 3 tests with DIN EN standards

<sup>4)</sup> depending on product thickness

# DESIGNATION, FORMS OF DELIVERY, LIMITING TEMPERATURES

Material group	Material no. according to DIN EN 10027	Steel name according to DIN EN 10027	Semi-finished	Documentation	Upper limiting temperature
					°C
Stainless ferritic steel	1.4511	X3CrNb17	Metal strip, sheet metal	DIN EN 10088	200
				VdTÜV-WB 422	
	1.4512	X2CrTi12	Metal strip, sheet metal	DIN EN 10088 SEW 400	350
Stainless austenitic steel	1.4301	X5CrNi18-10	Metal strip, sheet metal	DIN EN 10088-2	550 / 300 <sup>5)</sup>
	1.4306	X2CrNi19-11	Metal strip, sheet metal	DIN EN 10088-2	550 / 350 <sup>5)</sup>
	1.4541	X6CrNiTi18-10	Metal strip, sheet metal	DIN EN 10088-2	550 / 400 <sup>5)</sup>
	1.4571	X6CrNiMoTi17-12-2	Metal strip, sheet metal	DIN EN 10088-2	550 / 400 <sup>5)</sup>
	1.4404	X2CrNiMo17-12-2	Metal strip, sheet metal	DIN EN 10088-2	550 / 400 <sup>5)</sup>
	1.4435	X2CrNiMo18-14-3	Metal strip, sheet metal	DIN EN 10088-2	550 / 400 <sup>5)</sup>
	1.4565	X2CrNiMnMoNbN25-18-5-4	Metal strip, sheet metal	SEW 400	550 / 400 <sup>5)</sup>
	1.4539	X1NiCrMoCu25-20-5	Sheet metal, metal strip,	DIN EN 10088-2	550 / 400 <sup>5)</sup>
			Seamless tube	VdTÜV-WB 421	400
	1.4529	X1NiCrMoCuN25-20-7	Sheet metal, metal strip	DIN EN 10088-2	400
Seamless tube			VdTÜV-WB 502		
Highly heat-resistant austenitic steel	1.4948	X6CrNi18-10	Sheet metal, metal strip	DIN EN 10028-7	600
			Forging	DIN EN 10222-5	
			Seamless tube	DIN EN 10216-5	400 <sup>5)</sup>
	1.4958	X5NiCrAlTi31-20	Sheet metal, metal strip	DIN EN 10028-7	600
			Seamless tube	DIN EN 10216-5	400 <sup>5)</sup>

<sup>5)</sup> Limiting temperature at risk of intercrystalline corrosion

# STRENGTH VALUES AT AMBIENT TEMPERATURE (MINIMUM VALUES <sup>2)</sup>)

Material no. according to DIN EN 10027	Yield strength min.		Tensile strength	Elongation at break min.		Impact work > 10 mm thickness, transverse min.	Remarks	
				> 3 mm	< 3mm			
	R <sub>p0.2</sub>	R <sub>p1.0</sub>	R <sub>m</sub>	Thickness A <sub>5</sub>	Thickness A <sub>80</sub>	KV		
MPa	MPa	MPa	%	%	J			
1.4511	230		420 - 600		23		s ≤ 6	
1.4512	210		380 - 560		25		s ≤ 6	
1.4301	t 230	260	540 - 750	45	45	at 20 °C: 60	s ≤ 6	
	l 215	245		43	40			
1.4306	t 220	250	520 - 670	45	45	at 20 °C: 60	s ≤ 6	
	l 205	235		43	40			
1.4541	t 220	250	520 - 720	40	40	at 20 °C: 60	s ≤ 6	
	l 205	235		38	35			
1.4571	t 240	270	540 - 690	40	40	at 20 °C: 60	s ≤ 6	
	l 225	255		38	35			
1.4404	t 240	270	530 - 680	40	40	at 20 °C: 60	s ≤ 6	
	l 225	255		38	35			
1.4435	t 240	270	550 - 700	40	40	at 20 °C: 60	s ≤ 6	
	l 225	255		38	35			
1.4565	t 420	460	800 - 1000	30	25	at 20 °C: 55	s ≤ 30	
1.4539	t 240	270	530 - 730	35	35	at 20 °C: 60	s ≤ 6	
	l 225	255		33	30			
		220	250	520 - 720	40	40		
1.4529	t 300	340	650 - 850	40	40	at 20 °C: 60	s ≤ 50	
	l 285	325		38	35			
		300	340	600 - 800	40	40	at 20 °C: 84	
1.4948	t 230	260	530 - 740	45	45	at 20 °C: 60	s ≤ 6	
	t 195	230		490 - 690	35		at 20 °C: 60	s ≤ 250
	t 185	225		500 - 700	30		at 20 °C: 60	
1.4958	t 170	200	500 - 750	30	30	at 20 °C: 80	s ≤ 75	
	t 170	200		500 - 750	30			

<sup>2)</sup> Smallest value from lateral and transverse test piece

t = Test piece, transverse  
l = Test piece, longitudinal



# DESIGNATION, FORMS OF DELIVERY, LIMITING TEMPERATURES

Material group	Material no. according to DIN EN 10027 <sup>6)</sup>	Steel name according to DIN EN 10027	Trade name	Semi-finished	Documentation	Upper limiting temperature
						°C
Heat resistant steel	1.4828	X15CrNiSi20-12		Sheet metal, metal strip	DIN EN 10095 (SEW470)	900
	1.4876	X10NiCrAlTi32-20	INCOLOY 800	Metal strip, sheet metal, rod, seamless Tube, forging	SEW470	600
		X10NiCrAlTi32-20 H	INCOLOY 800 H		VdTÜV-WB 412	950
					VdTÜV-WB 434	900
DIN EN 10095	900					
Nickel-base alloys	2.4858	NiCr21Mo	INCOLOY 825	Metal strip, sheet metal	DIN 17750	
					VdTÜV-WB 432	450
					DIN 17744 <sup>7)</sup>	
	2.4816	NiCr15Fe	INCONEL 600	Metal strip, sheet metal	DIN EN 10095	1000
					VdTÜV-WB 305	450
			INCONEL 600 H		DIN 17750	
					VdTÜV-WB 305	450
	DIN 17742 <sup>7)</sup>					
	2.4819	NiMo16Cr15W	HASTELLOY C-276	Metal strip, sheet metal	DIN 17750	
					VdTÜV-WB 400	450
					DIN 17744 <sup>7)</sup>	
	2.4856	NiCr22Mo9Nb	INCONEL 625	Flat products, Metal strip, sheet metal	DIN EN 10095	900
					VdTÜV-WB 499	450
			INCONEL 625 H		DIN 17750	
	DIN 17744 <sup>7)</sup>					
2.4610	NiMo16Cr16Ti	HASTELLOY-C4	Metal strip, sheet metal	DIN 17750		
				VdTÜV-WB 424	400	
				DIN 17744 <sup>7)</sup>		
2.4360	NiCu30Fe	MONEL	Metal strip, sheet metal	DIN 17750		
				VdTÜV-WB 263	425	
			Metal strip, sheet metal, Seamless tube, Forging			
DIN 17743 <sup>7)</sup>						

<sup>6)</sup> The material number DIN 17007 is valid for nickel-base alloys

<sup>7)</sup> chemical composition

# STRENGTH VALUES AT AMBIENT TEMPERATURE (MINIMUM VALUES <sup>2)</sup>)

Material no. according to DIN EN 10027 <sup>6)</sup>	Yield strength min.		Tensile strength	Elongation at break min.		Impact work min.	Remarks
	R <sub>p0.2</sub>	R <sub>p1.0</sub>	R <sub>m</sub>	A <sub>5</sub>	A <sub>90</sub>	KV	
	MPa	MPa	MPa	%	%	J	
1.4828	230	270	500 - 750		28		Solution-annealed (+AT), s ≤ 3 mm
1.4876	210		500 - 750	22			soft-annealed (+A)
	210	240	500 - 750	30		at 20 °C: 150 <sup>8)</sup>	
	170	200	450 - 700	30			solution-annealed (+AT)
2.4858	170	210	450 - 680		28		
	240	270	≥ 550	30			soft-annealed (+A), F55, s ≤ 30 mm
2.4816	235	265	550 - 750		30	at 20 °C: 80	
	240		500 - 850		30		soft-annealed (+A), F55
	200	230	550 - 750	30		at 20 °C: 150 <sup>8)</sup>	
	180	210	≥ 550		30		solution-annealed (+AT), (+AT), F50
2.4819	180	210	500 - 700	35		at 20 °C: 150 <sup>8)</sup>	
	310	330	≥ 690	30			solution-annealed (+AT), F69, s ≤ 5 mm
2.4856	310	330	730 - 1000	30		at 20 °C: 96	
	415		820 - 1050		30		soft-annealed (+A), s ≤ 3 mm
	400	440	830 - 1000	30			soft-annealed (+A)
2.4610	275	305	≥ 690		30	at 20 °C: 100	solution annealed (+AT), F69
	305	340	≥ 690	40		at 20 °C: 96	solution-annealed (+AT), s ≤ 5
	280	315	700 - 900	40		at 20 °C: 96	5 < s ≤ 30
2.4360							
	175	205	≥ 450	30			soft-annealed (+A), F45, s ≤ 50
	175		450 - 600	30		at 20 °C: 120	soft-annealed (+A), F45

<sup>2)</sup> Smallest value from lateral and transverse test piece

<sup>6)</sup> The material number DIN 17007 is valid for nickel-base alloys

<sup>8)</sup> Value a<sub>k</sub> in J/cm<sup>2</sup>

# DESIGNATION, FORMS OF DELIVERY, LIMITING TEMPERATURES

Material group	Material no.	Designation according to	Semi-finished	Documentation	Upper limiting temperature
					°C
	according to DIN EN 1652				
Copper-based alloys	CW354H	CuNi30Mn1Fe	Metal strip, sheet metal	DIN-EN 1652 AD-W 6/2	350
Copper	CW024A	Cu-DHP	Metal strip, sheet metal	DIN-EN 1652 AD-W 6/2	250
Copper-tin alloys	CW452K	CuSn6	Metal strip, sheet metal	DIN-EN 1652	
Copper-zinc alloys	CW503L	CuZn20	Metal strip, sheet metal	DIN-EN 1652	
	CW508L	CuZn37	Metal strip, sheet metal	DIN-EN 1652	
	2.0402 <sup>9)</sup> (CW617N)	CuZn40Pb2	Metal strip, sheet metal	DIN 17670 DIN 17660	
	according to DIN EN 485-2				
Wrought aluminium alloys	EN AW-5754	EN AW-Al Mg3	Metal strip, sheet metal	DIN EN 485-2	
				DIN EN 575-3	
				AD-W 6/1	150 (AD-W)
	EN AW-6082	EN AW-Al Si1MgMn	Metal strip, sheet metal	DIN-EN 485-2 DIN-EN 573-3	
	according to DIN 17007				
Pure nickel	2.4068	LC-Ni 99	Metal strip, sheet metal	VdTÜV-WB 345	600
titanium	3.7025	Ti 1	Metal strip, sheet metal	DIN 17 850	250
				DIN 17 860	
				VdTÜV-WB 230	
Tantalum		Ta	Metal strip, sheet metal	VdTÜV-WB 382	250

<sup>9)</sup> according to DIN 17670

# STRENGTH VALUES AT AMBIENT TEMPERATURE (MINIMUM VALUES <sup>2)</sup>)

Material no.	Yield strength min.		Tensile strength	Elongation at break min.	Impact work min.	Remarks
	R <sub>p0.2</sub>	R <sub>p1.0</sub>	R <sub>m</sub>	A <sub>5</sub>	KV	
	MPa	MPa	MPa	%	J	
CW354H	≥ 120		350 - 420	35 <sup>13)</sup>		R350 (F35) <sup>11)</sup> 0.3 ≤ s ≤ 15
CW024A	≤ 100		200 - 250	42 <sup>13)</sup>		R200 (F20) <sup>11)</sup> s > 5 mm
	≤ 140		220 - 260	33 <sup>14)</sup> / 42 <sup>13)</sup>		R220 (F22) <sup>11)</sup> 0.2 ≤ s ≤ 5 mm
CW452K	≤ 300		350 - 420	45 <sup>14)</sup>		R350 (F35) <sup>11)</sup> 0.1 ≤ s ≤ 5 mm
				55 <sup>13)</sup>		
CW503L	≤ 150		270 - 320	38 <sup>14)</sup>		R270 (F27) <sup>11)</sup> 0.2 ≤ s ≤ 5 mm
				48 <sup>13)</sup>		
CW508L	≤ 180		300 - 370	38 <sup>14)</sup>		R300 (F30) <sup>11)</sup> 0.2 ≤ s ≤ 5 mm
				48 <sup>13)</sup>		
2.0402	≤ 300		≥ 380	35		- (F38) <sup>12)</sup> 0.3 ≤ s ≤ 5 mm
EN AW-5754	≥ 80		190 - 240	14 (A50)		0.5 < s ≤ 1.5 mm Status: 0 / H111 DIN EN values
EN AW-6082	≤ 85		≤ 150	14 (A50)		0.4 ≤ s ≤ 1.5 mm Status: 0 ; DIN EN values
2.4068	≥ 80	≥ 105	340 - 540	40		
3.7025	≥ 180	≥ 200	290 - 410	30 / 24 <sup>15)</sup>	62	0.4 < s ≤ 8 mm
TANTAL-ES	≥ 140		≥ 225	35 <sup>10)</sup>		0.1 ≤ s ≤ 5.0, smelted with electronic beam
TANTALUM-GS	≥ 200		≥ 280	30 <sup>10)</sup>		0.1 ≤ s ≤ 5.0, sintered in vacuum

<sup>2)</sup> Smallest value from lateral and transverse test piece

<sup>10)</sup> Gauge length l<sub>0</sub> = 25 mm

<sup>11)</sup> Status description according to DIN EN 1652 or. (--) according to DIN 17670

<sup>12)</sup> According to DIN, material not contained in the DIN EN 1652

<sup>13)</sup> Details in DIN EN for s > 2.5 mm

<sup>14)</sup> Elongation at break A50, details in DIN EN for s ≤ 2.5 mm

<sup>15)</sup> A50 for thicknesses ≤ 5 mm

# CHEMICAL COMPOSITION (PERCENTAGE BY MASS)

Material group	Material no.	Designation	C <sup>16)</sup>	Si max.	Mn	P max.	S max.	Cr	Mo	Ni	Other Elements
Non-alloy steel	1.0254	P235TR1	≤ 0.16	0.35	≤ 1.20	0.025	0.020	≤ 0.30	≤ 0.08	≤ 0.30	Cu ≤ 0.30 Cr+Cu+Mo+Ni ≤ 0.70
	1.0255	P235TR2	≤ 0.16	0.35	≤ 1.20	0.025	0.020	≤ 0.30	≤ 0.08	≤ 0.30	Cu ≤ 0.30 Cr+Cu+Mo+Ni ≤ 0.70 Al <sub>ges</sub> ≥ 0.02
	1.0427	C22G1	0.18 - 0.23	0.15 - 0.35	0.4 - 0.9	0.035	0.03	≤ 0.30			Al <sub>ges</sub> ≥ 0.015
General construction steel	1.0038	S235JRG2	≤ 0.17		≤ 1.40	0.045	0.045				N ≤ 0.009
	1.0050	E295				0.045	0.045				N ≤ 0.009
	1.0570	S355J2G3	≤ 0.20	0.55	≤ 1.6	0.035	0.035				Al <sub>ges</sub> ≥ 0.015
Heat resisting non-alloy steel	1.0460	C22G2	0.18 - 0.23	0.15 - 0.35	0.4 - 0.90	0.035	0.030	≤ 0.30			
Heat-resisting steel	1.0345	P236GH	≤ 0.16	0.35	0.4 - 1.20	0.03	0.025	≤ 0.30	≤ 0.08	≤ 0.30	Nb,Ti,V Al <sub>ges</sub> ≥ 0.020 Cu ≤ 0.30 Cr+Cu+Mo+Ni ≤ 0.70
	1.0425	P265GH	≤ 0.20	0.4	≤ 0.5	0.03	0.025	≤ 0.30	≤ 0.08	≤ 0.30	
	1.0481	P295GH	0.08 - 0.20	0.40	0.9 - 1.50	0.03	0.025	≤ 0.30	≤ 0.08	≤ 0.30	
	1.5415	16Mo3	0.12 - 0.20	0.35	0.4 - 0.90	0.03	0.025	≤ 0.30	0.25 - 0.35	≤ 0.30	Cu ≤ 0.3
	1.7335	13CrMo4-5	0.08 - 0.18	0.35	0.4 - 1.00	0.030	0.025	0.7 - 1.15	0.4 - 0.6		Cu ≤ 0.3
	1.7380	10 CrMo9-10	0.08 - 0.14	0.5	0.4 - 0.80	0.03	0.025	2 - 2.50	0.9 - 1.10		Cu ≤ 0.3
	1.0305	P235G1TH	≤ 0.17	0.1 - 0.35	0.4 - 0.80	0.040	0.040				

<sup>16)</sup> The C content is dependent on the thickness. The values are for a thickness of ≤ 16 mm.

# CHEMICAL COMPOSITION (PERCENTAGE BY MASS)

Material group	Material no.	Designation	C max.	Si max.	Mn	P max.	S max.	Cr	Mo	Ni	Other Elements
Fine grain construction steel	1.0562	P355N	0.2	0.50	0.9 - 1.70	0.03	0.025	≤ 0.3	≤ 0.8	≤ 0.5	Al <sub>ges</sub> ≥ 0,020 (s, DIN EN 10028-3)  Cu, N, Nb, Ti, V Nb + Ti + V ≤ 0.12
	1.0565	P355NH	0.2	0.50	0.9 - 1.70	0.03	0.025	≤ 0.3	≤ 0.8	≤ 0.5	
	1.0566	P355NL1	0.18	0.50	0.90 - 1.70	0.030	0.020	≤ 0.3	≤ 0.8	≤ 0.5	
	1.1106	P355NL2	0.18	0.50	0.9 - 1.70	0.025	0.015	≤ 0.3	≤ 0.8	≤ 0.5	
Stainless ferritic steel	1.4511	X3CrNb17	0.05	1.00	≤ 1.0	0.040	0.015	16.0 - 18			Nb: 12 x %C - 1.00
	1.4512	X2CrTi12	0.03	1.00	≤ 1.0	0.04	0.015	10.5 - 12.5			Ti: 6 x (C+N) - 0.65
Stainless austenitic steel	1.4301	X5CrNi18-10	0.07	1.00	≤ 2.0	0.045	0.015	17.0 - 19.5		8.0 - 10.5	
	1.4306	X2CrNi19-11	0.03	1.00	≤ 2.0	0.045	0.015	18.0 - 20.0		10.0 - 12.0	
	1.4541	X6CrNiTi18-10	0.08	1.00	≤ 2.0	0.045	0.015	17.0 - 19.0		9.0 - 12.0	Ti: 5 x %C - 0.7
	1.4571	X6CrNiMoTi 17 12 2	0.08	1.00	≤ 2.0	0.045	0.015	16.5 - 18.5	2 - 2.5	10.5 - 13.5	Ti: 5 x %C - 0.7
	1.4404	X2CrNiMo 17 12 2	0.03	1.00	≤ 2.0	0.045	0.015	16.5 - 18.5	2.0 - 2.5	10.0 - 13.0	N ≤ 0.11
	1.4435	X2CrNiMo 18 14 3	0.03	1.00	≤ 2.0	0.045	0.015	17.0 - 19.0	2.5 - 3.0	12.5 - 15.0	
	1.4565	X2CrNiMnMoNbN2 5-18-5-4	0.04	1.00	4.50 - 6.5	0.030	0.015	21.0 - 25	3.0 - 4.5	15.0 - 18	Nb ≤ 0.30, N: 0.04 - 0.15
	1.4539	X1NiCrMoCu 25-20-5	0.02	0.70	≤ 2.0	0.030	0.010	19.00 - 21	4.0 - 5.0	24.0 - 26.0	Cu: 1.20- 2.00 N: ≤ 0.15
	1.4529	X2NiCrMoCuN 25-20-7	0.02	0.50	≤ 1.0	0.03	0.01	19.0 - 21.0	6.0 - 7.0	24 - 26	Cu: 0.5 - 1 N: 0.15 - 0.25

# CHEMICAL COMPOSITION (PERCENTAGE BY MASS)

Material group	Material no.	Designation	C	Si	Mn	P max.	S max.	Cr	Mo	Ni	Other Elements
Highly heat-resistant austenitic steel	1.4948	X6CrNi18-10	0.04 - 0.08	≤ 1.00	≤ 2.0	0.035	0.015	17.0 - 19.0		8.0 - 11.0	
	1.4919	X6CrNiMo 17-13	0.04 - 0.08	≤ 0.75	≤ 2.0	0.035	0.015	16.0 - 18.0	2.0 - 2.5	12.0 - 14.0	
Heat-resistant steel	1.4828	X15CrNiSi 20-12	≤ 0.2	1.50 - 2.00	≤ 2.0	0.045	0.015	19.0 - 21.0		11.0 - 13.0	N: ≤ 0.11
	1.4876 (DIN EN 10095)	X10NiCrAlTi32-21 INCOLOY 800H	≤ 0.12	≤ 1.0	≤ 2.0	0.030	0.015	19.0 - 23.0		30.0 - 34.0	Al: 0.15 - 0.60 Ti: 0.15 - 0.60
Nickel-base alloy	2.4858	NiCr21Mo INCOLOY 825	≤ 0.025	≤ 0.5	≤ 1.0	0.02	0.015	19.5 - 23.5	2.5 - 3.5	38.0 - 46.0	Ti, Cu, Al, Co ≤ 1.0
	2.4816	NiCr15Fe INCONEL 600 INCONEL 600 H	0.05 - 0.1	≤ 0.5	≤ 1.0	0.02	0.015	14.0 - 17.0		> 72	Ti, Cu, Al
	2.4819	NiMo16Cr15W HASTELLOY C-276	≤ 0.01	0.08	≤ 1.0	0.02	0.015	14.5 - 16.5	15 - 17	Residue	V, Co, Cu, Fe
	2.4856	NiCr22Mo9Nb INCONEL 625 INCONEL 625 H	0.03 - 0.1	≤ 0.5	≤ 0.5	0.02	0.015	20.0 - 23.0	8.0 - 10.0	> 58	Ti, Cu, Al Nb/Ta: 3.15 - 4.15 Co ≤ 1.0
	2.4610	NiMo16Cr16Ti HASTELLOY C4	≤ 0.015	≤ 0.08	≤ 1.0	0.025	0.015	14.0 - 18.0	14.0 - 17.0	Residue	Ti, Cu, Co ≤ 2.0
	2.4360	NiCu30Fe MONEL	≤ 0.15	≤ 0.5	≤ 2.0		0.02				> 63
Copper-based alloy	CW354H	CuNi 30 Mn1 Fe CUNIFER 30	≤ 0.05		0.5 - 1.50		0.050			30.0 - 32.0	Cu: residue, Pb, Zn

# CHEMICAL COMPOSITION (PERCENTAGE BY MASS)

Material group	Material no.	Designation	Cu	Al	Zn	Sn	Pb	Ni	Ti	Ta	Other Elements
Copper	CW024A	Cu DHP	≥ 99.9								P: 0.015 - 0.04
Copper-tin alloy	CW452K	CuSn 6	Residue		≤ 0.2	5.5 - 7.0	≤ 0.2	≤ 0.2			P: 0.01 - 0.4, Fe: ≤ 0.1
Copper-Zinc alloy	CW503L	CuZn 20	79.0 - 81.0	≤ 0.02	Residue	≤ 0.1	≤ 0.05				
	CW508L	CuZn 37 Brass	62.0 - 64.0	≤ 0.05	Residue	≤ 0.1	≤ 0.1	≤ 0.3			
	2.0402	CuZn 40 Pb 2	57.0 - 59.0	≤ 0.1	Residue	≤ 0.3	1.5 - 2.5	≤ 0.4			
Wrought aluminium alloy	EN AW-5754	EN AW-Al Mg3	≤ 0.1	Residue	≤ 0.1				≤ 0.15		Si, Mn, Mg
	EN AW-6082	EN AW-Al Si1MgMn	≤ 0.1	Residue	≤ 0.2				≤ 0.1		Si, Mn, Mg
Pure nickel	2.4068	LC-Ni 99	≤ 0.025					≥ 99	≤ 0.1		C ≤ 0.02 Mg ≤ 0.15 S ≤ 0.01 Si ≤ 0.2
titanium	3.7025	Ti							Residue		N ≤ 0.05 H ≤ 0.013 C ≤ 0.06 Fe ≤ 0.15
Tantalum	-	Ta						≤ 0.01	≤ 0.01	Residue	



# STRENGTH VALUES AT ELEVATED TEMPERATURES

Material no. according to DIN	Type of value	Strength values in MPa																							
		Temperatures in °C																							
		RT <sup>1)</sup>	100	150	200	250	300	350	400	450	500	550	600	700	800	900									
1.0254	R <sub>p0.2</sub>	235																							
1.0255	R <sub>p0.2</sub>	235																							
1.0427	R <sub>p0.2</sub>	220	210	190	170	150	130	110																	
1.0038	R <sub>p0.2</sub>	205	187		161	143	122									(values according to AD W1)									
1.0570	R <sub>p0.2</sub>	315	254		226	206	186									(values according to AD W1)									
1.0460	R <sub>p0.2</sub>	240	230	210	185	165	145	125	100	80															
	R <sub>p1/10000</sub>								136	80	(53)														
	R <sub>p1/100000</sub>								95	49	(30)														
	R <sub>m10000</sub>								191	113	(75)														
	R <sub>m100000</sub>								132	69	(42)														
1.0345	R <sub>p0.2</sub>	206	190	180	170	150	130	120	110																
	R <sub>p1/10000</sub>								136	80	(53)														
	R <sub>p1/100000</sub>								95	49	(30)														
	R <sub>m10000</sub>								191	113	(75)														
	R <sub>m100000</sub>								132	69	(42)														
1.0425	R <sub>p0.2</sub>	234	215	205	195	175	155	140	130																
	R <sub>p1/10000</sub>								136	80	(53)														
	R <sub>p1/100000</sub>								95	49	(30)														
	R <sub>m10000</sub>								191	113	(75)														
	R <sub>m100000</sub>								132	69	(42)														
1.0481	R <sub>p0.2</sub>	272	250	235	225	205	185	170	155																
	R <sub>p1/10000</sub>								167	93	49														
	R <sub>p1/100000</sub>								118	59	29														
	R <sub>m10000</sub>								243	143	74														
	R <sub>m100000</sub>								179	85	41														
1.5415	R <sub>p0.2</sub>	275	264	250	233	213	194	175	159	147	141														
	R <sub>p1/10000</sub>									216	132	(84)													
	R <sub>p1/100000</sub>									167	73	(36)													
	R <sub>m10000</sub>									298	171	(102)													
	R <sub>m100000</sub>									239	101	(53)													
1.7335	R <sub>p0.2</sub>				230	220	205	190	180	170	165														
	R <sub>p1/10000</sub>									245	157	(53)													
	R <sub>p1/100000</sub>									191	98	(24)													
	R <sub>m10000</sub>									370	239	(76)													
	R <sub>m100000</sub>									285	137	(33)													
	R <sub>m200000</sub>									260	115	(26)													

<sup>1)</sup> Ambient temperature values valid to 50 °C



# STRENGTH VALUES AT ELEVATED TEMPERATURES

Material no. according to DIN	Type of value	Strength values in MPa															
		Temperatures in °C															
		RT <sup>17)</sup>	100	150	200	250	300	350	400	450	500	550	600	700	800	900	
1.4948	R <sub>0.2</sub>	230	157	142	127	117	108	103	98	93	88	83	78				
	R <sub>0.1</sub>	260	191	172	157	147	137	132	127	122	118	113	108				
	R <sub>m</sub>	530	440	410	390	385	375	375	375	370	360	330	300				
	R <sub>0.1/10000</sub>										147	121	94	35			
	R <sub>0.1/100000</sub>										114	96	74	22			
	R <sub>m 10000</sub>										250	191	132	55			
	R <sub>m 100000</sub>										192	140	89	28			
	R <sub>m 200000</sub>										176	125	78	22			
1.4919	R <sub>0.2</sub>	205	177		147		127		118		108	103	98				
	R <sub>0.1</sub>	245	211		177		157		147		137	132	128				
	R <sub>0.1/10000</sub>										180	125	46				
	R <sub>0.1/100000</sub>										125	85	25				
	R <sub>m 10000</sub>										250	175	65				
	R <sub>m 100000</sub>										175	120	34				
1.4958	R <sub>0.2</sub>	170	140	127	115	105	95	90	85	82	80	75	75				
	R <sub>0.1</sub>	200	160	147	135	125	115	110	105	102	100	95	95				
	R <sub>m</sub>	500	465	445	435	425	420	418	415	415	415						
	R <sub>0.1/10000</sub>												115	58			
	R <sub>0.1/100000</sub>												(85)	(40)			
	R <sub>m 10000</sub>												290	225	140	69	
	R <sub>m 100000</sub>												215	160	95	44	
R <sub>m 200000</sub>												(196)	(143)	(83)	(38)		
1.4828	R <sub>0.2</sub>	230	205		180		160		150		140		130				
	R <sub>0.1</sub>	270	245		220		205		190		180		170			DIN EN 14917	
	R <sub>m</sub>	550	470		430		410		400		370		320				
	R <sub>0.1/1000</sub>												120	50	20	8	
	R <sub>0.1/100000</sub>												80	25	10	4	
	R <sub>m 1000</sub>												190	75	35	15	
	R <sub>m 100000</sub>												120	36	18	8.5	
R <sub>m 200000</sub>												65	16	7.5	3.0		
1.4876 solution- annealed (+AT)	R <sub>0.2</sub>	170	140		115		95		85		80		75				
	R <sub>0.1</sub>	200	160		135		115		105		100		95			DIN EN 14917	
	R <sub>m</sub>	450	425		400		390		380		360		300				
	R <sub>0.1/1000</sub>												130	70	30	13	
	R <sub>0.1/100000</sub>												90	40	15	5	
	R <sub>m 1000</sub>												200	90	45	20	
	R <sub>m 100000</sub>												152	68	30	10	
R <sub>m 200000</sub>												114	47	19	4		
2.4858	R <sub>0.2</sub>	235	205	190	180	175	170	165	160	155							
	R <sub>0.1</sub>	265	235	220	205	200	195	190	185	180							
	R <sub>m</sub>	550	530		515		500		490	485							

<sup>17)</sup> Ambient temperature values valid to 50 °C

# STRENGTH VALUES AT ELEVATED TEMPERATURES

Material no. according to DIN	Type of value	Strength values in MPa															
		Temperatures in °C															
		RT <sup>17)</sup>	100	150	200	250	300	350	400	450	500	550	600	700	800	900	
2.4816 DIN EN 10095	R <sub>p0.2</sub>	200	180		165		155		150	145							
	R <sub>m</sub>	550	520		500		485		480	475							
		-750															
	R <sub>p0.2</sub>	180	170		160		150		150	145							
	R <sub>m</sub>	500	480		460		445		440	435							
		-700															
	R <sub>p1/10000</sub>										153		91	43	18	8	
	R <sub>p1/100000</sub>										126		66	28	12	4	
R <sub>m1000</sub>												160	96	38	22		
R <sub>m10000</sub>												297	138	63	29	13	
R <sub>m100000</sub>												215	97	42	17	7	
2.4819 VdTÜV-WB 400	R <sub>p0.2</sub>	310	280		240		220		195								
	R <sub>p1</sub>	330	305		275		215		200								
2.4856	R <sub>p0.2</sub>	400	350		320		300		280	270							
	R <sub>p1/100000</sub>											250	90	30	10		
	R <sub>m100000</sub>											290	135	45	18		
	R <sub>m1000</sub>												260	107	34		
	R <sub>m100000</sub>												190	63	20		
2.4610	R <sub>p0.2</sub>	305	285		255		245		225								
	R <sub>p1</sub>	340	315		285		270		260								s ≤ 5
2.4360	R <sub>p0.2</sub>	175	150	140	135	132	130	130	130	(130)							
	R <sub>m</sub>	450	420	400	390	385	380	375	370	(370)							
CW354H	R <sub>p1</sub>	140	130	126	123	120	117	112									
	R <sub>p1/10000</sub>				107	99	92	84									
	R <sub>p1/100000</sub>				102	94	86	78									
	K/S <sup>18)</sup>		93	87	84	82	80	78	75								
CW024A AD-W 6/2	R <sub>p1</sub>	60	55	55													
	R <sub>m</sub>	200	200	175	150	125											State R200
	K/S <sup>18)</sup>	57	57	50	43	36											
	R <sub>p1</sub>	65	58	58													
	R <sub>m</sub>	220	220	195	170	145											State R220
	K/S <sup>18)</sup>	63	63	56	49	41											
EN-AW 5754	R <sub>p0.2</sub>	80	70														
	R <sub>m</sub>		(80)	45													
	R <sub>m100000</sub>																

<sup>17)</sup> Ambient temperature values valid to 50 °C

<sup>18)</sup> K/S = Permissible tension in accordance with AD-W 6/2 for 10<sup>5</sup> h





# MATERIAL DESCRIPTIONS ACCORDING TO INTERNATIONAL SPECIFICATIONS

Material no. according to DIN EN	USA			Japan		
	Standard	UNS designation	Semi-finished product/ application/title	Standard	Designation	Semi-finished product/ application/title
1.0254	ASTM A 53	K02504 Grade A, type S	Welded and seamless black-oxidised and hot-dip galvanised steel pipes	JIS G 3445	STKM12A	Pipe for mechanical engineering
	ASTM A 519	K02504 Grade 1020	Seamless pipe	JIS G 3454	STPG370	Pipe for pressure vessels
	ASTM A 523	K02504 Grade B	Seamless, resistance welded pipe	JIS G 3457	STPY400	Welded pipe
1.0255	ASTM A106	Grade A	Seamless heat resisting pipe	JIS G 3455	STS 370	Pipe for pressure vessels
1.0038	ASTM A 500	K03000	Welded and seamless molded parts made of cold-formed steel			
1.0050	ASTM A 573	Grade 70	Sheet metal with improved toughness	JIS G 3101	SS490	General construction steels
1.0570	ASTM A105		Forging for pipelines	JIS G 3106	SM490YB	Steels for welded structures
	ASTM A 662	Grade C	Sheet metal for pressure vessels	JIS G 3106	SM520B	Steels for welded structures
1.0345	ASTM A 414	K02201 Grade A	Sheet metal for pressure vessels	JIS G 3115	SPV450	Sheet metal for pressure vessels
1.0425	ASTM A 414	K02505 Grade D	Sheet metal for pressure vessels	JIS G 3115	SPV355	Sheet metal for pressure vessels
1.0481	ASTM A 414	K02704 Grade F	Sheet metal for pressure vessels	JIS G 3118	SGV410	Sheet metal for pressure vessels
1.5415	ASTM A 204	K12320 Grade A	Sheet metal for pressure vessels	JIS G 3458	STPA12	pipes
1.7335	ASTM A 387	K11789 Grade 12	Sheet metal made of Cr-Mo alloy steel for pressure tanks	JIS G 3462	STBA22	Boiler and heat exchanger pipes
1.7380	ASTM A 387	K21590 Grade 22	Sheet metal made of Cr-Mo alloy steel for pressure tanks	JIS G 4109	SCMV4	Sheet metal for pressure vessels
1.0305	ASTM A 106	K02501 Grade A	Seamless heat resisting pipe	JIS G 3461	STB340	Pipe, boiler pipe
1.0562	ASTM A 299	K02803 Grade A	Sheet metal for pressure vessels	JIS G 3106	SM490 A;B;C	Steels for welded structures
	ASTM A 714	K12609 Grade II	Welded and seamless pipes made of high tensile, low-alloy steel	JIS G 3444	STK490	Pipes for general use
1.0565	ASTM A 633	K12037 Grade D	Sheet, high-strength			
	ASTM A 662	K12037 Grade C	Sheet metal for pressure vessels			
1.0566	ASTM A 662	K02701 Grade C	Sheet metal for pressure vessels	JIS G 3126	SLA365	Sheet for pressure vessels, low temperature

# MATERIAL DESCRIPTIONS ACCORDING TO INTERNATIONAL SPECIFICATIONS

Material no. according to DIN EN	Korea			China		
	Standard	Designation	Semi-finished product/ application/title	Standard	Designation	Semi-finished product/ application/title
1.0254	KS D 3583	SPW 400	Welded pipes made of carbon steel			
1.0255	KS D 3562	SPPS 410	Carbon steel, pipelines for high-pressure applications	GB/T 5312	410	Seamless pipe for shipbuilding
1.0038				GB/T 700	Q235B U12355	(non-alloy construction steels)
1.0050	KS D 3503	SS 490	General construction steels	GB/T 700	Q275 U12752	(non-alloy construction steels)
1.0570	KS D 3517	STKM 16C	Non-alloy steel pipes for general mechanical engineering	GB 6654	16MnR L20162	Sheet metal for pressure vessels
				GB/T 8164	16Mn L20166	Metal strip for welded pipes
1.0345	KS D 3521	SPPV 450	Steel plates for pressure vessels for medium working temperatures	GB 6654	20R	Sheet metal for pressure vessels
1.0425	KS D 3521	SPPV 315	Steel plates for pressure vessels for medium working temperatures	GB/T 713	22Mng	Steel sheets for boilers and pressure vessels
1.0481						
1.5415	KS D 3572	STHA 12	Pipes for boilers and heat exchangers	GB 5310	15MoG A65158	Seamless pipes for pressure tanks
1.7335	KS D 3572	STHA 22	Pipes for boilers and heat exchangers	YB/T 5132	12CrMo A30122	Sheet metal for alloy construction steels
1.7380	KS D 3543	SCMV 4	Cr-Mo steel for pressure vessels	GB 5310	12Cr2MoG A30138	Seamless pipes for pressure tanks
1.0305				GB/T 5312	360	Seamless pipe for shipbuilding
1.0562						
1.0565						
1.0566	KS D 3541	SLA 1 360	Steel plates for pressure vessels (low temperature)	GB/T 714	Q420q-D L14204	Steels for bridge building



# MATERIAL DESCRIPTIONS ACCORDING TO INTERNATIONAL SPECIFICATIONS

Material no. according to DIN EN	USA			Japan		
	Standard	UNS designation	Semi-finished product/ application/title	Standard	Designation	Semi-finished product/ application/title
1.1106	ASTM A 707	K12510 Grade L3	Forged flanges made of alloy and non-alloy steel for use at low temperatures	JIS G 3444	STK490	Pipes for general use
1.4511				JIS G 4305	SUS430LX	Cold-rolled sheet metal, steel plates and metal strip
1.4512	ASTM A 240	S40900 409	Sheet metal and metal strip made of heat-resistant, stainless steel Cr and Cr-Ni steel for pressure tanks	JIS G 4312	SUH409L	Sheet metal, rust-resistant, heat resistant
1.4301	ASTM A 240	S30400 304	Sheet metal and metal strip made of heat-resistant, stainless steel Cr and Cr-Ni steel for pressure tanks	JIS G 4305	SUS304	Cold-rolled sheet metal, steel plates and metal strip
1.4306	ASTM A 240	S30403 304L	Sheet metal and metal strip made of heat-resistant, stainless steel Cr and Cr-Ni steel for pressure tanks	JIS G 4305	SUS304L	Cold-rolled sheet metal, steel plates and metal strip
1.4541	ASTM A 240	S32100 321	Sheet metal and metal strip made of heat-resistant, stainless steel Cr and Cr-Ni steel for pressure tanks	JIS G 4305	SUS321	Cold-rolled sheet metal, steel plates and metal strip
1.4571	ASTM A 240	S31635 316Ti	Sheet metal and metal strip made of heat-resistant, stainless steel Cr and Cr-Ni steel for pressure tanks	JIS G 4305	SUS316Ti	Cold-rolled sheet metal, steel plates and metal strip
1.4404	ASTM A 240	S31603 316L	Sheet metal and metal strip made of heat-resistant, stainless steel Cr and Cr-Ni steel for pressure tanks	JIS G 4305	SUS316L	Cold-rolled sheet metal, steel plates and metal strip
1.4435	ASTM A 240	S31603 316L	Sheet metal and metal strip made of heat-resistant, stainless steel Cr and Cr-Ni steel for pressure tanks	JIS G 4305	SUS316L	Cold-rolled sheet metal, steel plates and metal strip
1.4565	ASTM A 240	S34565	Sheet metal and metal strip made of heat-resistant, stainless steel Cr and Cr-Ni steel for pressure tanks			
1.4539	ASTM A 240	N08904 904L	Sheet metal and metal strip made of heat-resistant, stainless steel Cr and Cr-Ni steel for pressure tanks	JIS G 4305	SUS890L	Cold-rolled sheet metal, steel plates and metal strip
1.4529	ASTM A 240	N08925	Sheet metal and metal strip made of heat-resistant, stainless steel Cr and Cr-Ni steel for pressure tanks			

# MATERIAL DESCRIPTIONS ACCORDING TO INTERNATIONAL SPECIFICATIONS

Material no. according to DIN EN	Korea			China		
	Standard	Designation	Semi-finished product/ application/title	Standard	Designation	Semi-finished product/ application/title
1.1106				GB 6654	16MnR L20163	Sheet metal for pressure vessels
1.4511	KS D 3698	STS 430LX	Cold-rolled sheet metal, steel plates and metal strip			
1.4512				GB /T 3280	022Cr11NbTi S11168	Hot-rolled sheet metal made of heat-resistant steel, ferritic
1.4301	KS D 3698	STS 304	Cold-rolled sheet metal, steel plates and metal strip	GB /T 3280	06Cr19Ni10 S30408	Cold-rolled sheet metal and metal strips, austenitic
1.4306	KS D 3698	STS 304L	Cold-rolled sheet metal, steel plates and metal strip	GB /T 3280	022Cr19Ni10 S30403	Cold-rolled sheet metal and metal strips, austenitic
1.4541	KS D 3698	STS 321	Cold-rolled sheet metal, steel plates and metal strip	GB /T 3280	06Cr18Ni11Ti S32168	Cold-rolled sheet metal and metal strips, austenitic
1.4571	KS D 3698	STS 316Ti	Cold-rolled sheet metal, steel plates and metal strip	GB /T 3280	06Cr17Ni12Mo2Ti S31668	Cold-rolled sheet metal and metal strips, austenitic
1.4404	KS D 3698	STS 316L	Cold-rolled sheet metal, steel plates and metal strip	GB /T 3280	022Cr17Ni12Mo2 S31603	Cold-rolled sheet metal and metal strip, austenitic
1.4435	KS D 3698	STS 316L	Cold-rolled sheet metal, steel plates and metal strip	GB /T 3280	022Cr17Ni12Mo2 S31603	Cold-rolled sheet metal and metal strips, austenitic
1.4565				GB /T 3280	022Cr24Ni- 17Mo5Mn6NbN	Cold-rolled sheet metal and metal strips, austenitic
1.4539				GB /T 3280	015Cr21Ni- 26Mo5Cu2	Cold-rolled sheet metal and metal strips, austenitic
1.4529	KS D 3698	STS 317J5L	Cold-rolled sheet metal, steel plates and metal strip			

# MATERIAL DESCRIPTIONS ACCORDING TO INTERNATIONAL SPECIFICATIONS

Material no. according to DIN EN	USA			Japan		
	Standard	UNS designation	Semi-finished product/ application/title	Standard	Designation	Semi-finished product/ application/title
1.4948	ASTM A 240	S30409 304H	Sheet metal and metal strip made of heat-resistant, non-rusting Cr and Cr-Ni steel for pressure tanks			
1.4919	ASTM A 240	S31609 316H	Sheet metal and metal strip made of heat-resistant, non-rusting Cr and Cr-Ni steel for pressure tanks			
1.4958	ASTM A 240	N08810	Sheet metal and metal strip made of heat-resistant, non-rusting Cr and Cr-Ni steel for pressure tanks			
1.4828	ASTM A 167	S30900 309	Sheet metal and metal strip made of non-rusting, heat-resistant Cr-Ni steel	JIS G 4312	SUH309	Heat-resistant sheet metals and steel plates
1.4876	ASTM A 240	N08800 800H	Sheet metal and metal strip made of heat-resistant, non-rusting Cr and Cr-Ni steel for pressure tanks	JIS G 4902	NCF800	Special alloys in sheet metals
2.4858	ASTM B 424	N08825	Sheet metal and metal strips made of Ni-Fe-Cr-Mo-Cu alloys (UNS N08825 and N08221)	JIS G 4902	NCF825	Special alloys in sheet metals
2.4816	ASTM B 168	N06600	Sheet metal and metal strips made of Ni-Cr-Fe, and Ni-Cr-Co-Mo alloys (UNS N06600 and N06690)			
2.4819	ASTM B 575	N10276	Sheet metal and metal strips made of low Ni-Mo-Cr alloys			
2.4856	ASTM B 443	N06625	Sheet metal and metal strips made of Ni-Cr-Mo-Nb alloy (UNS N06625)	JIS G 4902	NCF625	Special alloys in sheet metals
2.4610	ASTM B 575	N06455	Sheet metal and metal strips made of low Ni-Mo-Cr alloys			
2.4360	ASTM B 127	N04400	Sheet metal and metal strips made of Ni-Cu alloy (UNS N04400)	JIS H 4551	NW4400	Sheet metals and metal strips made of nickel and nickel alloy

# MATERIAL DESCRIPTIONS ACCORDING TO INTERNATIONAL SPECIFICATIONS

Material no. according to DIN EN	Korea			China		
	Standard	Designation	Semi-finished product/ application/title	Standard	Designation	Semi-finished product/ application/title
1.4948				GB /T 3280	07Cr19Ni10	Cold-rolled sheet metal and metal strips, austenitic
1.4919						
1.4958						
1.4828	KS D 3732	STR 309	Heat-resistant sheet metals and steel plates	GB/T 4238	16Cr23Ni13 S38210	Heat-resistant steels; austenitic
1.4876	KS D 3532	NCF 800	Special alloys in sheet metal and steel plates	GB/T 15007	NS 111 H01110	Rustproof alloys
2.4858	KS D 3532	NCF 825	Special alloys in sheet metal and steel plates	GB/T 15007	NS 142 H01402	Rustproof alloys
2.4816				GB/T 15007	NS 3102 H06600	Rustproof alloys
2.4819				GB/T 15007	NS 3304 H10276	Rustproof alloys
2.4856	KS D 3532	NCF 625	Special alloys in sheet metal and steel plates	GB/T 15007	NS 3306 H06625	Rustproof alloys
2.4610				GB/T 15007	NS 3305 H06455	Rustproof alloys
2.4360				GB/T 15007	NS6400 H04400	Rustproof alloys

# CORROSION RESISTANCE

A high-magnification scanning electron micrograph (SEM) showing a dark, granular surface heavily covered with irregular, light-colored flakes and fragments. These fragments represent corrosion products, likely oxides or hydroxides, that have formed on the underlying material. The distribution is uneven, with some larger, more distinct flakes and many smaller, more dispersed particles.

## Basic principles

Flexible metal elements are basically suitable for the transport of critical fluids if a sufficient resistance is ensured against all corrosive media that may occur during the entire lifetime. The flexibility of the corrugated elements like bellows or corrugated hoses generally require their wall thickness to be considerably smaller than that of all other parts of the system in which they are installed. As therefore increasing the wall thickness to prevent damages caused by corrosion is not reasonable, it becomes essential to select a suitable material for the flexible elements which is sufficiently resistant. Special attention must be paid to all possible kinds of corrosion, especially pitting corrosion, intercrystalline corrosion, crevice corrosion, and stress corrosion cracking, (see Types of corrosion). This leads to the fact that in many cases at least the ply of the flexible element that is exposed to the corrosive fluid has to be chosen of a material with even higher corrosion resistance than those of the system parts it is connected to (see Resistance table).

## Types of corrosion

According to EN ISO 8044, corrosion is the "physicochemical interaction between a metal and its environment that results in changes in the properties of the metal, and which may lead to significant impairment of the function of the metal, the environment, or the technical system, of which these form a part. This interaction is often of an electrochemical nature". Different types of corrosion may occur, depending on the material and on the corrosion conditions. The most important corrosion types of ferrous and non-ferrous metals are briefly described below.

## Uniform surface corrosion

A general corrosion proceeding at almost the same rate over the whole surface. The loss in weight which occurs is generally specified either in  $\text{g/m}^2\text{h}$  or as the reduction in the wall thickness in  $\text{mm/year}$ . This type of corrosion includes the corrosion which commonly is found on unalloyed steel (e. g. caused by oxidation in the presence of water). Stainless steels can only be affected by uniform corrosion under extremely unfavourable conditions, e.g. caused by liquids, such as acids, bases and salt solutions.

## Pitting corrosion

Under certain conditions, attacks in limited areas can be described as pitting corrosion due to their appearance. The attack occurs from the effect of chlorine, bromine or iodine ions, particularly when present in watery solutions. This form of corrosion or the resulting selective attack is not calculable in comparison with surface corrosion and for that reason it can only be mastered using an appropriate selection of materials. With stainless steels, the resistants relating to pitting corrosion increases with rising molybdenum content in the chemical composition of the material. The so-called pitting resistant equivalent ( $PRE = Cr \% + 3.3 \cdot Mo \% + 30 N \%$ ) can be used to compare roughly the resistants of the materials in relation to pitting corrosion; the higher the cumulated reaction value, the greater the resistants.

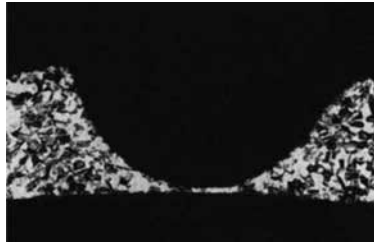


Fig. 18.1 Pitting corrosion on a cold strip made of austenitic steel. Sectional view (50-fold enlargement).

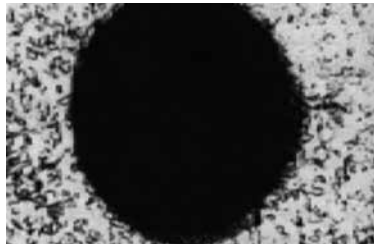


Figure 18.2 Sectional view (50-fold enlargement).

## Intergranular corrosion

Intergranular corrosion is a localised, selective corrosion, which primarily attacks the grain boundaries. This type of corrosion is caused by separation in the material structure, which leads to a reduction in corrosion resistance in the areas near to the grain boundaries. This form of corrosion can lead in stainless steels to complete disintegration of the grain bond (intergranular attack).

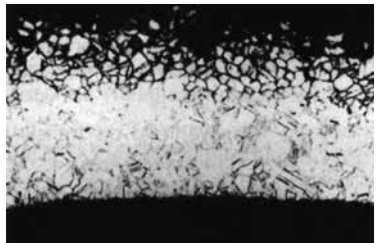


Figure 18.3 Intercrystalline corrosion (intergranular attack) in material 1.4828. Sectional view (100-fold enlargement).

These sensitization processes are dependent on temperature and time in CrNi alloys, whereby the critical temperature range is between 550 and 650 °C and the period up to the onset of the sensitization processes differs according to the type of steel. This must be taken into account, for example, when welding thick-walled parts with a high thermal capacity. These deposit-related changes in the structure can be reversed by means of solution annealing (1000 – 1050 °C). This type of corrosion can be avoided by using stainless steels with low carbon content ( $\leq 0.03\%$  C) or containing elements, such as titanium or niobium. For our products made of stainless steels this may be stabilized material qualities like 1.4541, 1.4571 or low-carbon qualities like 1.4404, 1.4306. The resistance of materials to intergranular corrosion can be verified by a standardized test (Monypenny - Strauss test according to ISO 3651-2). Certificates to be delivered by the material supplier, proving resistant to intergranular corrosion according to this test are therefore asked for in order and acceptance test specifications.

### **Stress corrosion cracking**

This type of corrosion is observed most frequently in austenitic materials, subjected to tensile stresses and exposed to a corrosive agent. The most important agents are alkaline solutions and those containing chloride. The crack configuration can be transgranular or intergranular. Whereas the transgranular form only occurs at temperatures higher than 50 °C (especially in solutions containing chloride), the intergranular form can be observed already at room temperature in austenitic materials in a neutral solutions containing chloride.



At temperatures above 100 °C stress corrosion cracking (SCC) can already be caused by very small concentrations of chloride or lye – the latter always leads to the transgranular form. Stress corrosion cracking takes the same forms in non-ferrous metals as in austenitic materials. Damage caused by intergranular stress corrosion cracking can occur in nickel and nickel alloys in highly concentrated alkalis at temperatures above 400 °C, and in solutions or water vapour containing hydrogen sulphide at temperatures above 250 °C. A careful choice of materials based on a detailed knowledge of the existing operating conditions is necessary to prevent from this type of corrosion damage.

### Crevice corrosion

Owing to the risk of crevice corrosion design and applications should be avoided which represent crevice or encourage deposits.

The resistance of high-alloy steels and Ni-based alloys to this type of corrosion increases in line with the molybdenum content of the materials. Again pitting resistance equivalent (PRE) (see Pitting corrosion) can be taken as criteria for assessing the resistance to crevice corrosion.

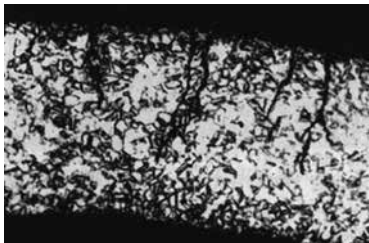


Figure 18.4 Transgranular stress corrosion cracking on a cold strip made of austenitic steel. Sectional view (50-fold enlargement).

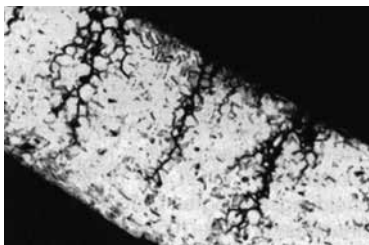


Figure 18.5 Intergranular stress corrosion cracking on a cold strip made of austenitic steel. Sectional view (50-fold enlargement).



Figure 18.6 Crevice corrosion on a cold strip made from austenitic steel. Sectional view (50-fold enlargement).

## Dezincification

A type of corrosion which occurs primarily in copper-zinc alloys with more than 20 % zinc. During the corrosion process the copper is separated from the brass, usually in the form of a spongy mass. The zinc either remains in solution or is separated in the form of basic salts above the point of corrosion. The dezincification can be either of the surface type or locally restricted, and can also be found deeper inside. Conditions which encourage this type of corrosion include thick coatings from corrosion products, lime deposits from the water or other deposits of foreign bodies on the metal surface. Water with high chloride content at elevated temperature in conjunction with low flow velocities favor the occurrence of dezincification.

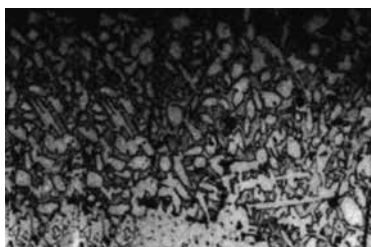


Figure 18.7 Dezincification on a Copper-Zinc alloy (CuZn37). Sectional view (100-fold enlargement).

## Contact corrosion

A type of corrosion which may result from a combination of different materials. In practice, so-called "practical galvanic potentials" are used, for example in seawater, to assess the risk of contact corrosion. Metals which are close together on this graph are mutually compatible; the anodic metal corrodes increasingly in line with the distance between two metals.

## Corrosion Resistance

Materials which can be encountered in both the active and passive state must also be taken into account. A CrNi alloy, for example, can be activated by mechanical damage to the surface, by deposits (diffusion of oxygen made more difficult) or by corrosion products on the surface of the material. This may result in a potential difference between the active and passive surfaces of the metal, and in material erosion (corrosion) if an electrolyte is present.

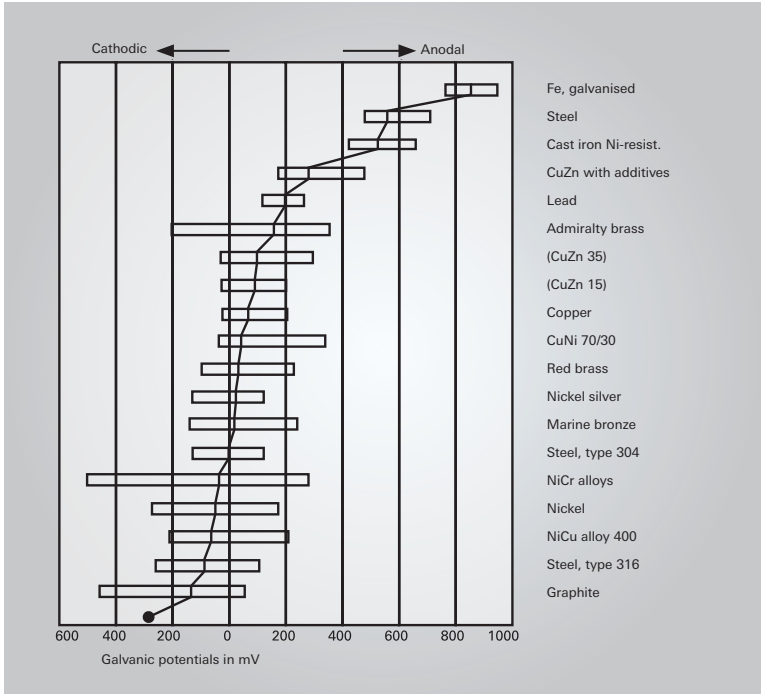


Figure 18.9 Galvanic potential in seawater

Source: DECHEMA material tables.

# RESISTANCE TABLES

The table below provides a summary of the resistance to different media for metal materials most commonly used for flexible elements.

The table has been drawn up on the basis of relevant sources in accordance with the state of the art; it makes no claims to completeness. The data constitutes recommendations only, for which no liability can be accepted.

The main function of the table is to provide the user with an indication of which materials are suitable or of restricted suitability for the projected application, and which can be rejected right from the start. The exact composition of the working medium, varying operating states and other boundary operating conditions must be taken into consideration when choosing the material.

## Table keys

Assessment	Corrosion behaviour	Suitability
0	resistant	suitable
1	uniform corrosion with reduction in thickness of up to 1 mm/year	restricted suitability
P	risk of pitting corrosion	
S	risk of stress corrosion cracking	
2	hardly resistant, uniform corrosion with reduction in thickness of more than 1 mm/year up to 10 mm/year	not recommended
3	not resistant (different forms of corrosion)	unsuitable

## Meanings of abbreviations

adp:	acid dew point
bp:	boiling point
cs:	cold-saturated (at room temperature)
dr:	dry condition
hy:	hydrous solution
me:	melted
mo:	moist condition
sa:	saturated (at boiling point)



Medium				Materials																		
Designation Chemical formula		Concentration	Temperature	Stainless steels				Nickel alloys				Copper alloys			Pure metals							
				Non-/low- alloy steels	Ferritic steels	Austenitic steels	Austenitic + Mo	Incoloy 825 2.4858	Inconel 600 2.4816	Inconel 625 2.4856	Hastelloy-C 2.4610 / 2.4619	Monel 2.4360	Cunifer 30 2.0882	Tombac	Bronze	Copper	Nickel	Titanium	Tantalum	Aluminium	Silver	
																						%
<b>Adipine acid</b> HOOC(CH <sub>2</sub> ) <sub>4</sub> COOH		All	200	0	0	0	0	0	0	0	0	0										
<b>Alcohol</b> s. Ethylene alcohol																						
<b>Allyl alcohol</b> CH <sub>2</sub> CHCH <sub>2</sub> OH		100	bp			0	0	0	0	0	1	0				0						
<b>Allyl chloride</b> CH <sub>2</sub> =CHCH <sub>2</sub> Cl		100	25					0	0	0	0	0				0						
<b>Alum</b> KAl(SO <sub>4</sub> ) <sub>2</sub>		100	20	1	1	0	0	0	1	0	0	1				1		0	1			
	hy	10	20	1	0	0	0			1	1	1	1	1		0	0	1				
	hy	10	<80	1	1	0	0			1	1	1	1		0	0						
	sa			3	3	1				3	3	3										
<b>Aluminium</b> Al		me	750	3	3	3	3				3					3	3					
<b>Aluminium acetate</b> (CH <sub>3</sub> -COO) <sub>2</sub> Al(OH)		hy	3	20	3	0	0	0		0						0	0					
	hy			3	0	0	0			1						0	1					
	sa																					
<b>Aluminium chloride</b> AlCl <sub>3</sub>		hy	5	20	3	3	3	P	1	1	0	0	1	3	3	1	3	1	0	0	3	1
<b>Aluminium fluoride</b> AlF <sub>3</sub>		hy	10	25	3	3	3	3			1	1				1	1	0	3	1	1	
<b>Aluminium formate</b> Al(HCOO) <sub>3</sub>					1	0	0	0	0	0	0	0			0	1	0	0	0	0		
<b>Aluminium hydroxide</b> Al(OH) <sub>3</sub>		hy	10	20	1	3	0	0	0	0	0	0	1	0		0		0	0	1		
<b>Aluminium nitrate</b> Al(NO <sub>3</sub> ) <sub>3</sub>					0	0	0	0	0	0	0	0						0	0	1		
<b>Aluminium oxide</b> Al <sub>2</sub> O <sub>3</sub>			20	1	1	0	0	0		0	0	3	0	0	0	0			0	3		
<b>Aluminium sulphate</b> Al <sub>2</sub> (SO <sub>4</sub> ) <sub>3</sub>		hy	10	<bp	3	3	3	0	0	1	0	1	3	3	3	3	3	1	0	0	3	
	hy	15	50	3	3	3	1		1	1	1	1	1	1	1	1	1	1	0	0	3	

Medium				Materials																	
Designation Chemical formula		Concentration %	Temperature °C	Materials																	
				Stainless steels				Nickel alloys				Copper alloys			Pure metals						
				Non-/low- alloy steels	Ferritic steels	Austenitic steels	Austenitic + Mo	Incoloy 825 2.4858	Inconel 600 2.4816	Inconel 625 2.4856	Hastelloy-C 2.4610 / 2.4819	Monel 2.4360	Cunifer 30 2.0882	Tombac	Bronze	Copper	Nickel	Titanium	Tantalum	Aluminium	Silver
Ammonia NH <sub>3</sub>	dr	10	20	0	0	0	0	0	0	0	0	0	0	0	0	0	0	0	0	0	0
	hy	2	20	0	0	0	0	0	0	0	0	0	0	0	0	3	S	S	0	0	0
	hy	20	40	0	0	0	0	0	1	1	1	3				3			3	0	0
	hy	hs	bp	0	0	0	0	0	3	1	1	3							0	0	0
Ammonium acetate CH <sub>3</sub> -COONH <sub>4</sub>				1	0	0	0												0	0	
Ammonium alum NH <sub>4</sub> Al(SO <sub>4</sub> ) <sub>2</sub>	hy	cs	20			0	0												3	0	
Ammonium bicarbonate (NH <sub>4</sub> )HCO <sub>3</sub>	hy			0	0	0	0	1	3			3	3			3				0	0
Ammonium bifluoride NH <sub>4</sub> HF <sub>2</sub>	hy	10	25	3	3	3	3				0								3	0	
	hy	100	20	3	3	0	0				0								3	0	
Ammonium bromide NH <sub>4</sub> Br	hy	10	25	3	P	P	P	0		0	1									0	1
Ammonium carbonate (NH <sub>4</sub> ) <sub>2</sub> CO <sub>3</sub>	hy	1	20	0	0	0	0	0	0	0	1	0	1			1				0	0
		50	bp	0	0	0	0	0	0	0	1	0	1			1	1			0	0
Ammonium chloride NH <sub>4</sub> Cl	hy	1	20	1	P	P	P	0	0	0	0	0	1	S	S	1	1	0	0	1	1
	hy	10	100	1	P	P	P	0	0	0	0	1	1	S	S	1	1	0	1	1	1
	hy	50	bp	1	P	P	P	0	1	0	1	1	1			1	1	0	1	1	1
Ammonium fluoride NH <sub>4</sub> F	hy	10	25	1	1	0	0				0								1	0	
	hy	hg	70	3																	
	hy	20	80	3	3	3					0			3	3	3			0		
Ammonium fluorosilicate (NH <sub>4</sub> ) <sub>2</sub> SiF <sub>6</sub>	hy	20	40	3	1	0	0	0	0	0	0	0	0					0			
Ammonium formate HCOONH <sub>4</sub>	hy	10	20	1	0	0	0	0	0	0	0	0	0						0	0	0
		10	70																0	0	0
Ammonium hydroxide NH <sub>4</sub> OH		100	20	0	0	0	0	0	0	0	0	3	3			3	0	0	0	0	1
Ammonium nitrate NH <sub>4</sub> NO <sub>3</sub>	hy	5	20	3	0	0	0	0	1	0	0	3	3			3				0	0
	hy	100	bp	3	0	0	0	0		0	3			3	3	3				0	0
Ammonium oxalate (COONH <sub>4</sub> ) <sub>2</sub>	hy	10	20	1	1	0	0		1	0	0	1	1			1		0	0		
	hy	10	bp	3	3	1	0		1	0		1	1			1		1	0		
Ammonium perchlorate NH <sub>4</sub> ClO <sub>4</sub>	hy	10	20		P	P	P				1							0			





Medium			Materials																	
Designation Chemical formula		Concentration Temperature	Non-/low- alloy steels	Stainless steels			Nickel alloys				Copper alloys			Pure metals						
				Ferritic steels	Austenitic steels	Austenitic + Mo	Incoloy 825 2.4858	Inconel 600 2.4816	Inconel 625 2.4856	Hastelloy-C 2.4610 / 2.4819	Monel 2.4360	Cunifer 30 2.0882	Tombac	Bronze	Copper	Nickel	Titanium	Tantalum	Aluminium	Silver
Antifreeze Glysantene		20	0	0	0	0	0	0	0	0	0									
Antimony Sb	me	100	650	3					0	0							3		3	
Antimony tric chloride SbCl <sub>3</sub>	dr hy	20 100	0 1	3 3	3 3	3 3								0 0				3 3		
Aqua regia 3HCl+HNO <sub>3</sub>		20	3	3	3	3		3		3	3	3	3		0	0			1	
Arsenic As		65 110			0 1	0 1														
Arsenious acid H <sub>3</sub> AsO <sub>4</sub>	hy hy	20 90	3		0 3	0 3		3			3		3					3		
Asphalt		20	0	0	0	0					0	0	0	0	0				0	
Azobenzene C <sub>6</sub> H <sub>5</sub> -N=N-C <sub>6</sub> H <sub>5</sub>		20	0	0	0	0	0	0	0	0						0	0	0		
Baking powder	mo		1	0	0	0	0	0	0	0				1					0	
Barium carbonate BaCO <sub>3</sub>		20	3	0	0	0	0	0	0	0	0	0	0	0	0	0	0	0	1	
Barium chloride BaCl <sub>2</sub>	hy hy	5 25	20 bp	P P	P P	P P	1 1	1 1	0 0	0 0	1 1	3		3	1	0	0	0	3	
Barium hydroxide Ba(OH) <sub>2</sub>	solid hy hy hy hy sa	100 All All 100 815 20 50	20 20 bp 815 20 bp 100	0 0 0 0 0 0	0 0 0 0 0 0	0 0 0 0 0 0	0 0 0 0 0 0	1 1 0 1 0 1	0 0 1 1 0 1	0 0 1 1 0 1	0 0 1 0 1 1	0 0 0 0 0 0	0 0 0 0 0 0	0 0 1 0 0 0	0 0 0 0 0 0			3 3 0 0 0 3		
Barium nitrate Ba(NO <sub>3</sub> ) <sub>2</sub>	hy	All	bp		0	0	0	0	1	0		3		3	0	0	0	0		
Barium sulphate BaSO <sub>4</sub>		25	0	0	0	0	0	0	0	0	0	0	0	0	1	0	0	0		
Barium sulphide BaS		25	0	0	0						3	1	3	3						



Medium				Materials																
Designation Chemical formula		Concentration Temperature	Non-/low- alloy steels	Stainless steels			Nickel alloys				Copper alloys			Pure metals						
				Ferritic steels	Austenitic steels	Austenitic + Mo	Incoloy 825 2.4858	Inconel 600 2.4816	Inconel 625 2.4856	Hastelloy-C 2.4610 / 2.4819	Monel 2.4360	Cunifer 30 2.0882	Tombac	Bronze	Copper	Nickel	Titanium	Tantalum	Aluminium	Silver
Butyl alcohol CH <sub>3</sub> -CH <sub>2</sub> -CH <sub>2</sub> -CH <sub>2</sub> -OH		100 100	20 bp	0 0	0 0	0 0	0 0	0 0	0 0	0 0	0 0	0 0	0 0	0 0	0 0	0 0	0 0	0 0	0 0	
Butyric acid CH <sub>3</sub> -CH <sub>2</sub> -CH <sub>2</sub> -COOH	hy hy sa	cs bp	20 bp	3 3	0 3	0 3	0 3	1 1	3 3	0 0	1 1			3 3				0 1		
Cadmium Cd	me				3	3														
Calcium Ca			850	3	3	3														
Calcium bisulphite CaSO <sub>3</sub>		cs sa	20 bp	3 3	3 3	0 3	0 0					1	3	1	0		0 0			
Calcium carbonate CaCO <sub>3</sub>			20	1	0	0	0	0	0	0	0	0	0	0	0	0	0	0	0	
Calcium chlorate Ca(ClO <sub>3</sub> ) <sub>2</sub>	hy hy	10	20 100	P 3	P 3	P P	1 1	1 1	1 1	1 1	3 3			1 1	1 1		0 0			
Calcium chloride CaCl <sub>2</sub>	hy hy cs sa	5 10	100 20	3 3 3 3	P P P P	P P P P	0 0 0 0	0 0 0 0	0 0 0 0	0 0 1 3	0 0 3 3	1 1		1 0 0 1	0 0 1 P	0 0 0 0	0 0 0 3	3 3 3 3		
Calcium hydroxide Ca(OH) <sub>2</sub>				0	0	0	0	1	1	0	0	1	0	0	0	1	1	0	0	
Calcium hypochlorite Ca(OCl) <sub>2</sub>	hy hy	2	20	3 3	3 3	3 P	P P	0 0	3 1	0 1	0 3	3 3		3 3	3 0	0 0	0 3	3 3		
Calcium nitrate Ca(NO <sub>3</sub> ) <sub>2</sub>		All	20 100	3 3	0 0	0 0	0 0	0 0	0 0	0 0	0 0					0 0	0 0			
Calcium oxalate (COO) <sub>2</sub> Ca	mo		20	1	0	0	0	0	0	0	0	0	0			0	0	3		
Calcium oxide CaO			20	0	0	0	0	0	0	0	0	0	0	0	0	0	0	3		
Calcium sulphate CaSO <sub>4</sub>	mo mo		20 bp	1 1	0 0	0 0	0 0	0 0	0 0	0 0	0 0	0 0	0 0	0 0	0 0	0 0	0 0	0 0	1 1	
Calcium sulphite CaSO <sub>3</sub>	hy hy sa	cs		0 0	0 0	0 0								1 1	0 0	0 0	0 0	1 1		

Medium			Materials																	
Designation Chemical formula		Concentration Temperature	Non-/low- alloy steels	Stainless steels			Nickel alloys				Copper alloys			Pure metals						
				Ferritic steels	Austenitic steels	Austenitic + Mo	Incoloy 825 2.4858	Inconel 600 2.4816	Inconel 625 2.4856	Hastelloy-C 2.4610 / 2.4819	Monel 2.4360	Cunifer 30 2.0882	Tombac	Bronze	Copper	Nickel	Titanium	Tantalum	Aluminium	Silver
<b>Carbolic acid</b> C <sub>6</sub> H <sub>5</sub> (OH)	hy	90	20 bp bp	0 3 3	0 3 3	0 3 3	0 0 0	0 0 0	0 0 0	1 1 1	0 0 0	1 0 0	0 0 0	0 0 0	0 0 0	0 0 0	0 3 3	0 0 0		
<b>Carbon dioxide</b> CO <sub>2</sub>	dr dr mo mo	100	<540 1000 20 25	0 3 1 3	1 0 1 0	0 0 0 0	0 0 0 0	0 0 0 0	0 0 0 0	0 0 0 1	0 0 0 0	0 3 1 1	0 1 1 0	0 0 0 0	0 0 0 0	0 0 0 0	0 3 3 3	0 0 0 0		
<b>Carbon monoxide</b> CO		100	20 <540	0 3	0 0	0 0	0 0	0 3	0 0	0 0	0 1	0 0	0 3	0 3	0 0	0 0	0 1	0 3	0 0	
<b>Carbon tetrachloride</b> CCl <sub>4</sub>	dr dr mo mo		20 bp 25 bp	0 1 1 3	0 0 1 1	0 0 1 1	0 0 0 0	0 0 0 0	0 0 0 0	0 0 0 0	0 0 0 0	0 0 1 0	0 0 0 0	0 0 0 0	0 0 0 0	0 3 3 3	0 0 0 0			
<b>Carbonic acid</b> CO <sub>2</sub> s. Carbon dioxide																				
<b>Caustic potash</b> s. Potassium hydroxide																				
<b>Caustic soda lye</b> s. Sodium hydroxide																				
<b>Chloral</b> CCl <sub>3</sub> -CHO			20						0								0	3		
<b>Chloramines</b>				3	3	1	0	0	0	0	0									
<b>Chloric acid</b> HClO <sub>3</sub>	hy		20	3	3	3	3	0		0						0	0	3	3	
<b>Chloride of lime</b> s. Calcium hypochlorite																				
<b>Chlorine</b> Cl <sub>2</sub>	dr dr dr mo mo	100	200 300 400 20 150	0 3 3 3 3	0 3 3 3 3	0 3 3 3 3	0 0 0 0 0	0 0 0 0 0	0 0 0 0 0	0 0 0 0 0	0 0 0 0 0	0 0 0 0 0	0 0 0 0 0	0 0 0 0 0	1 0 0 0 0	0 0 0 0 0	0 0 0 3 3	0 0 0 0 0		
<b>Chlorine dioxide</b> ClO <sub>2</sub>	hy	0.5	20	3	3	3	3			1			3		0	0				

Medium				Materials															
Designation Chemical formula		Concentration %	Temperature °C	Materials															
				Stainless steels			Nickel alloys				Copper alloys			Pure metals					
				Non-/low- alloy steels	Ferritic steels	Austenitic steels	Austenitic + Mo	Incoloy 825 2.4858	Inconel 600 2.4816	Inconel 625 2.4856	Hastelloy-C 2.4610 / 2.4819	Monel 2.4360	Cunifer 30 2.0882	Tombac	Bronze	Copper	Nickel	Titanium	Tantalum
Chloroacetic acid CH <sub>2</sub> -Cl-COOH	hy	All 30	20 80	3 3	3 3	3 3	3 3	3 3	3 3	1 3	1 3	3 3	3 3	3 3	3 3	1 3	0 0	0 0	3 3
Chlorobenzene C <sub>6</sub> H <sub>5</sub> Cl	dr mo	100	20	0 0	0 P	0 P	0 P	0 P	0 0	0 0	0 0	0 0	0 0	0 0	0 0	1 1	0 0	0 0	1 1
Chloroethane CH <sub>2</sub> =CHCl	dr		20 <400	0 0	0 0	0 0	0 0	0 0	0 0	0 0	0 0	0 0	0 0	0 0	0 0	0 0	0 0	0 0	0 0
Chloroethylene C <sub>2</sub> H <sub>3</sub> Cl s. Ethyl chloride																			
Chloroform CHCl <sub>3</sub>	dr mo			1 3	1 P	1 P	1 P	0 0	0 0	0 0	0 0	0 0	0 0	0 0	0 0	0 0	0 0	0 0	0 3
Chloromethane CH <sub>2</sub> Cl <sub>2</sub>	dr mo mo		20 20 bp	0 P P	P P P	P P P	P 0 1	0 1 1	1 1 1	1 0 1	0 0 0	0 0 0	0 0 0	0 0 0	0 1 1	0 0 0	0 0 0	0 3 3	
Chloromethane CH <sub>3</sub> Cl	dr mo mo	100	20 20 100	0 3 P	0 P P	0 P P	0 P P	0 0 0	0 0 0	0 0 0	0 0 0	0 0 0	0 0 0	0 0 1	0 0 0	0 0 0	0 0 0	0 3 3	
Chloronaphthalene C <sub>10</sub> H <sub>7</sub> Cl				0	0	0	0	0	0	0	0	0	0	0	0	0	0	0	0
Chlorophenol C <sub>6</sub> H <sub>4</sub> (OH)Cl				1	0	0	0			0									
Chlorosulphonic acid HSO <sub>3</sub> Cl	dr mo	100	20 20	0 3	0 3	0 3	0 3	0 1	0 1	0 1	0 1	0 1	0 1	0 3	0 3	0 3	0 3	0 0	3 3
Chrome alum KCr(SO <sub>4</sub> ) <sub>2</sub>	hy cs sa	1	20	3 3 3	3 3 3	0 1 3	0 0 3	0 0 0	0 0 1	3 0 1	3 0 1	3 0 3	3 0 3	3 0 3	3 1 3	0 0 0	0 0 0	1 3 3	
Chromic acid Cr <sub>2</sub> O <sub>3</sub> (H <sub>2</sub> CrO <sub>4</sub> )	hy hy hy hy hy hy hy	5	20 90 20 65 bp bp 20	3 3 3 3 3 3	3 0 3 3 3 3	0 0 3 3 3 3	0 1 3 3 3 1	3 3 3 3 3 3	0 0 0 0 3 3	3 3 3 3 3 3	3 3 3 3 3 3	3 3 3 3 3 3	3 3 3 3 3 3	3 3 3 3 3 3	0 0 0 0 0 0	0 0 0 0 0 0	1 0 0 0 0 0	0 0 1 0 3 3	



Medium			Materials																	
Designation Chemical formula	Concentration	Temperature	Stainless steels				Nickel alloys				Copper alloys				Pure metals					
			Non-/low- alloy steels	Ferritic steels	Austenitic steels	Austenitic + Mo	Incoloy 825 2.4858	Inconel 600 2.4816	Inconel 625 2.4856	Hastelloy-C 2.4610 / 2.4819	Monel 2.4360	Cunifer 30 2.0882	Tombac	Bronze	Copper	Nickel	Titanium	Tantalum	Aluminium	Silver
Cyclohexane (CH <sub>2</sub> ) <sub>6</sub>			0	0	0	0	0	0	0	0	0	0	0	0	0	0	0	0	0	0
<b>Diammonium phosphate</b> s. Ammonium phosphate																				
<b>Dibromethane</b> s. Ethylene bromide																				
<b>Dichlorethylene</b> C <sub>2</sub> H <sub>2</sub> Cl <sub>2</sub> s. Acetylene dichloride																				
<b>Dichloroethane</b> CH <sub>2</sub> Cl-CH <sub>2</sub> Cl s. Ethylene chloride																				
<b>Difluorodichloromethane</b> dr CF <sub>2</sub> Cl <sub>2</sub>	dr mo	bp 20 20		0	0	0	0	0	0	0	0							0	0	
<b>Diphenyl</b> C <sub>6</sub> H <sub>5</sub> -C <sub>6</sub> H <sub>5</sub>	100 100	20 400	0	0	S	S	0	0	0	0	0	0	0	0	0	0	0	0	0	0
<b>Ethane</b> CH <sub>3</sub> -CH <sub>3</sub>		20	0	0	0	0	0	0	0	0	0	0	0	0	0	0	0	0	0	0
<b>Ether</b> (C <sub>2</sub> H <sub>5</sub> ) <sub>2</sub> O s. Ethyl ether																				
<b>Ethereal oils</b>		20	1	0	0	0	0	0	0	0	0	0	0	0	0	0	0	0	0	0
<b>Ethyl alcohol</b> C <sub>2</sub> H <sub>5</sub> OH	All All	20 bp	0	0	0	0	0	0	0	0	0	0	0	0	0	0	0	0	0	0
<b>Ethyl benzene</b> C <sub>6</sub> H <sub>5</sub> -C <sub>2</sub> H <sub>5</sub>			1	0	0	0	0	0	0	0	0	0	0	0	0	0	0	0	0	0
<b>Ethyl chloride</b> C <sub>2</sub> H <sub>5</sub> Cl		0	S	S	S	0	0	0	1	0	0	1	1	1	0		0	1	0	
<b>Ethyl ether</b> (C <sub>2</sub> H <sub>5</sub> ) <sub>2</sub> O		0	0	0	0	0	0	0	1	0	0	0	0	0	0	0	0	0	0	0
<b>Ethylene</b> CH <sub>2</sub> =CH <sub>2</sub>		20	0	0	0	0														0

Medium				Materials																	
Designation Chemical formula		Concentration %	Temperature °C	Stainless steels			Nickel alloys				Copper alloys			Pure metals							
				Non-/low- alloy steels	Ferritic steels	Austenitic steels	Austenitic + Mo	Incoloy 825 2.4858	Inconel 600 2.4816	Inconel 625 2.4856	Hastelloy-C 2.4610 / 2.4619	Monel 2.4360	Cunifer 30 2.0882	Tombac	Bronze	Copper	Nickel	Titanium	Tantalum	Aluminium	Silver
<b>Ethylene bromide</b> CH <sub>2</sub> Br-CH <sub>2</sub> Br				1		0	0									0				3	
<b>Ethylene chloride</b> CH <sub>2</sub> ClCH <sub>2</sub> Cl	dr mo	100 100	20 20	0	P	P	P	1	0			0	1			1		0	0	0	1
<b>Ethylene glycol</b> CH <sub>2</sub> OH-CH <sub>2</sub> OH		100	20	0	0	0	0	0	1	0	0	1	0	0	0	0	1	0	0	0	
<b>Exhaust gases</b> s. Combustion gases																					
<b>Fats</b>				0	0	0	0	0	0	0	0	0	0	0	0	0	0	0	0	0	0
<b>Fatty acid</b> C <sub>17</sub> H <sub>33</sub> COOH		100 100 100 100 100	20 60 150 180 300	0 3	0 0	0 0	0 0	0 0	0 0	0 0	0 0	1 0	1 1	1 1	0 1	1 1	0 0	0 0	0 0	0 1	0 0
<b>Ferric (II) chloride</b> FeCl <sub>2</sub>	hy hy	10 cs	20	0		P	P			3	3	0	3	3	1	1	3	3	0	0	3
<b>Ferric (II) sulphate</b> FeSO <sub>4</sub>	hy	All	bp	0	0	0	0			0	0						3	0		3	
<b>Ferric (III) chloride</b> FeCl <sub>3</sub>	dr hy hy hy	100 5 10 50	20 25 65 20	0 3	P 3	P 3	P 3	1 3	3 3	0 0	3 3	3 3	3 3	3 3	3 3	3 3	0 0	0 0	0 0	3 3	
<b>Ferric (III) chloride</b> Fe(NO <sub>3</sub> ) <sub>3</sub>	hy hy	10 All	20 bp	3	0	0	0	0	3	3	3	3				3	0				
<b>Ferric (III) sulphate</b> Fe(SO <sub>4</sub> ) <sub>3</sub>	hy hy	<30 All	20 bp	3	0	0	0	0	3	0	1	3	3	3	3	3	0	0	0	3	3
<b>Fixing salt</b> s. Sodium thiosulphate																					
<b>Flue gases</b> s. Combustion gases																					
<b>Fluoride</b> F	mo dr dr dr		20 100 100 100	3	3	3	3			0	0	3	3	3	3	0	3			3	0





Medium			Materials																	
Designation Chemical formula		Concentration Temperature	Stainless steels			Nickel alloys				Copper alloys			Pure metals							
			Non-/low- alloy steels	Ferritic steels	Austenitic steels	Austenitic + Mo	Incoloy 825 2.4858	Inconel 600 2.4816	Inconel 625 2.4856	Hastelloy-C 2.4610 / 2.4819	Monel 2.4360	Cunifer 30 2.0882	Tombac	Bronze	Copper	Nickel	Titanium	Tantalum	Aluminium	Silver
<b>Glucose</b> C <sub>6</sub> H <sub>12</sub> O <sub>6</sub>	hy	20		0	0	0						0	1	0	0					
<b>Glutamic acid</b> HOOC-CH <sub>2</sub> -CH <sub>2</sub> - CHNH <sub>2</sub> -COOH		20 80	1 3	P P	P P	0 0	0 0	1 1	0 1	0 1	1 1					1				
<b>Glycerine</b> CH <sub>2</sub> OH-CHOH-CH <sub>2</sub> OH		20 100	20 bp	0 1	0 1	0 0	0 0	0 0	0 0	0 0	0 0	0 0	0 0	0 0	0 0	0 0	0 0	0 0	0 0	1
<b>Glycol</b> CH <sub>2</sub> OH-CH <sub>2</sub> OH s. Ethylene glycol																				
<b>Glycolic acid</b> CH <sub>2</sub> OH-COOH		20 98	bp	3 3	1 3	1 3	1 3			0 0						0 0		1 1		
<b>Glysantine</b> s. Antifreeze																				
<b>Hexachloroethane</b> CCl <sub>3</sub> -CCl <sub>3</sub> = Perchloroethane	dr mo	20 20								0 0	0 0					0 0		0 0		
<b>Hexafluorosilicic acid</b> s. hexafluorosilic hydrogen acid																				
<b>Hexamethylenete- tramine</b> (CH <sub>2</sub> ) <sub>6</sub> N <sub>4</sub>	hy hy	20 80	60 60	1 3	0 0	0 0				0 0										1
<b>Hydrazine</b> H <sub>2</sub> N-NH <sub>2</sub>		20		0	0		3	3		3					3				1	
<b>Hydrazine sulphate</b> (N <sub>2</sub> H <sub>4</sub> ) <sub>2</sub> SO <sub>4</sub>	hy	10	bp	3	3	3														
<b>Hydrobromic acid</b> HBr		20		3	3	3	3	3	3	3	3	3	3	3			0	3	3	

## Corrosion Resistance

Medium			Materials																	
Designation Chemical formula																				
			Concentration	Temperature	Stainless steels			Nickel alloys				Copper alloys			Pure metals					
					Non-/low- alloy steels	Ferritic steels	Austenitic steels	Austenitic + Mo	Incoloy 825 2.4858	Inconel 600 2.4816	Inconel 625 2.4856	Hastelloy-C 2.4610 / 2.4819	Monel 2.4360	Cunifer 30 2.0882	Tombac	Bronze	Copper	Nickel	Titanium	Tantalum
%	°C																			
Hydrochloric acid HCl	0.2	20	3	3	P	P														
	0.5	20	3	3	3	P														
	0.5	bp	3	3	3	3														
	1	20	3	3	3	P	3	3			0	1	3	3	3	3	1	0	0	3
	2	65	3	3	3	3					0									3
	5	20	3	3	3	3	3	3			0	1	3		1					3
	15	20	3	3	3	3	3	3			0	3	3							3
	32	20	3	3	3	3					0	0								3
32	bp	3	3	3	3					3										3
Hydrochloric acid gas s. Hydrochloric																				
Hydrofluoric acid HF	10	20	3	3	3	3	1	1	0	0	1		3	3	3	1	3	3	3	3
	80	20	1				1	1	1	1	1				1	1	3	3	3	3
	80	bp							1	1							3	3	3	3
	90	30					1	1			0					1	3	3	3	3
Hydrofluoro- Hydrogen acid H <sub>2</sub> (SiF <sub>6</sub> ) Vapour	100	20	3	3	P	P			1	1		1	3	1	1					3
	25	20	3	3	3	3	1	1	1	1	3		3	1	1	1	3			3
	70	20	3	3	3	3			1	1							2			3
Hydrogen* H		<300	0	0	0	0			0	0			0		0					0
		>300	3	3	3	3			0	0										0
Hydrogen bromide HBr	dr	100	20	0	0	0	0													
	mo	30	20	3	3	3	3										0			
Hydrogen chloride HCl	dr		20	0	3	1	1	0	0	0			3	3	3					1
	dr		100	0	3	3	3	0	0	0			3		3					1
	dr		250	1	3	3	3	0	0	0			3		3					3
	dr		500	3	3	3	3	1	1	0			3		3					3
Hydrogen cyanide HCN	dr		20	3	0	0	0	0	1	0	0	1	3	3	3	1	0	0	0	0
	hy	20	20	3	1	0	0	0	1	0	0	1	3	3	3	1	0	0	0	0
	hy	cs	20	3	1	0	0	0	0	0	0	3	3	3	3	1	0	0	0	0
Hydrogen fluoride HF	5	20		3	3	3	3	0	0	0	0				3	0	3	3	3	3
	100	500		3	3	3	3	3	3	0	3		3		3	0	3	3	3	3
Hydrogen iodide / acid	dr		20	0	0	0	0													
	mo		20	3	3	3	3													
Hydrogen peroxide H <sub>2</sub> O <sub>2</sub>	All	20	3	3	0	0	0	1	0	0	1	3	3	3		3	1	3	0	0

Medium				Materials																	
Designation Chemical formula		Concentration	Temperature	Stainless steels			Nickel alloys				Copper alloys			Pure metals							
				Non-/low- alloy steels	Ferritic steels	Austenitic steels	Austenitic + Mo	Incoloy 825 2.4858	Inconel 600 2.4816	Inconel 625 2.4856	Hastelloy-C 2.4610 / 2.4619	Monel 2.4360	Cunifer 30 2.0882	Inmbac	Bronze	Copper	Nickel	Titanium	Tantalum	Aluminium	Silver
Hydrogen sulphide H <sub>2</sub> S	dr	100	20	1	S	0	0	0	0	1	0	1	0	0	0	0	0	0	0	1	
	dr	100	100	3	S	0	0							0					0		
	dr	100	200	3	3	0	0											0			
	mo		20	3	3	0	0	0	0	0	0	3	3	3	3	1	0		0	3	
Hydroquinone HO-C <sub>6</sub> H <sub>4</sub> -OH				3		0	0	0	0	0	0	1				1			0		
			20	3	3	3	3									0			3		
Hypochlorous acid HOCl			20	0	0	0	0	0	0	0	0	1	1	0	0	1	1				
				0	0	0	0	0	0	0	0	0	0	0	0	0	0	0	0	0	
Illuminating gas				0	0	0	0	0	0	0	0	1	1	0	0	1	1				
			20	0	0	0	0	0	0	0	0	0	0	0	0	0	0	0	0	0	
Indole			20	0	0	0	0	0	0	0	0	0	0	0	0	0	0	0	0	0	
Ink s. Gallic acid																					
Iodine J <sub>2</sub>	dr	100	20	0	P	P	P			0	0	3	3	3	3		3		0		
	mo		20	3	3	3	3			1	3					3	0		3	3	
	mo		bp	3	3	3	3			1	3					3			3	3	
Iodoform CHJ <sub>3</sub>	dr		60	0	0	0	0													0	
	mo		20	3	3	P	P														
Isatin C <sub>8</sub> H <sub>5</sub> NO <sub>2</sub>			20	1	0	0	0	0	0	0	0	0	0	0	0	0	0	0	0	0	
Kalinite s. Alum																					
			20	0	0	0	0	0	0	0	0					0	0	0	0	0	
Ketene (C <sub>n</sub> H <sub>2n+1</sub> ) <sub>2</sub> C=C=O			bp	0	0	0	0	0	0	0	0					0	0	0	0	0	
				0	0	0	0	0	0	0	0					0	0	0	0	0	
Lactic acid C <sub>3</sub> H <sub>5</sub> O <sub>3</sub>	hy	1	20	3	3	0	0	0	0	0	0	0	3	1	0		0	0	0	0	
	hy	All	20	3	3	1	0			0	0					0	0	0	3		
	hy	10	bp	3	3	3	3	0	3	0	3	1			1	3	0	0	3		
	hy	All	bp	3	3	3	1			0	0					0	0	0	3		
Lactose C <sub>12</sub> H <sub>22</sub> O <sub>11</sub>	hy		20	0	0	0	0	0	0	0	0	0	0	0	0	0	0	0	0	0	
Lead Pb	me		388	3	1	1	1	0		0	3				3	0	0				
			900	3	3	3	3			0											
Lead acetate (CH <sub>3</sub> -COO) <sub>2</sub> Pb	me			3	0	0	0			0	0			3	3				3		
Lead acid Pb(N <sub>3</sub> ) <sub>2</sub>		<20	<30					0	0	0	1					1					

\*All materials tend to become brittle under hydrogen atmosphere. For components with cyclic loads the materials 1.4404 oder 1.4435 should be selected.

# Corrosion Resistance

Medium			Materials																		
Designation Chemical formula		Concentration %	Temperature °C	Stainless steels				Nickel alloys				Copper alloys			Pure metals						
				Non-/low- alloy steels	Ferritic steels	Austenitic steels	Austenitic + Mo	Incoloy 825 2.4858	Inconel 600 2.4816	Inconel 625 2.4856	Hastelloy-C 2.4610 / 2.4819	Monel 2.4360	Cunifer 30 2.0882	Tombac	Bronze	Copper	Nickel	Titanium	Tantalum	Aluminium	Silver
<b>Lead nitrate</b> Pb(NO <sub>3</sub> ) <sub>2</sub>	hy		100	1	0	0	0	0	0	0	0	0	0	0	0	0	0	0	0		
<b>Lime</b> CaO s. Calcium oxide																					
<b>Lime milk</b>  Ca(OH) <sub>2</sub>			20 bp	0 0	1 1	0 0	0 0											0 0			
<b>Liquid ammonia</b> s. Ammonium hydroxide																					
<b>Lithium</b> Li	me		300	0	0	0	0	0	0	0	0	3	3	3	3	3	0		3		
<b>Lithium chloride</b> LiCl	hy	cs		3	3	3	L	0	0	0	0	1				0	0				
<b>Lithium hydroxide</b> LiOH	hy	All	20	1	0	0	0	0	0	0	0	0				0	0				
<b>Magnesium</b> Mg	me		650		1	3	3	3	3	3	3	3	3	3	3	3	0	0	3		
<b>Magnesium carbonate</b> MgCO <sub>3</sub>	hy hy		20 bp	0 0	0 0	0 0	0 0	0 0	0 0	0 0	0 0	0 0				0 0	0 0	0 0	1 1		
<b>Magnesium chloride</b> MgCl <sub>2</sub>	hy hy hy	5 5 50	20 bp bp	3 3 3	3 3 3	P 3 3	P 3 3	0 0 0	0 0 0	0 0 0	0 0 0	3 3 0			3 3 0	0 0 0	0 0 0	0 0 0	3 3 3		
<b>Magnesium hydroxide</b> Mg(OH) <sub>2</sub>	hy hy	cs		0 0		0 0	0 0	0 0	0 0	0 0	0 0	0 0	0 0	0 0	0 0	0 0	0 0	0 0	3 3		
<b>Magnesium nitrate</b> Mg(NO <sub>3</sub> ) <sub>2</sub>		cs		0	0	0	0	3	3	3	0	3	0	0	3	3	0	0	1		
<b>Magnesium oxide</b> MgO s. Magnesium hydroxide																					
<b>Magnesium sulphate</b> MgSO <sub>4</sub>	hy hy hy	0.1 5 50	20 20 bp	0 3 3	1 1 1	0 0 0	0 0 0	0 1 0	0 0 1	0 0 1	0 1 0	0 3 0	0 0 0	0 0 1	1 0 0	0 0 0	0 0 0	0 0 0	3 0 0		
<b>Maleic acid</b> HOOC-HC=CH-COOH	hy hy	5 50	20 100	3 3	0 0	0 0	0 0	0 1	0 1	0 0	1 0				1			0 0			

18



Medium			Materials																		
Designation Chemical formula			Concentration	Temperature	Non-/low- alloy steels																
					Stainless steels			Nickel alloys				Copper alloys			Pure metals						
					Ferritic steels	Austenitic steels	Austenitic + Mo	Incoloy 825 2.4858	Inconel 600 2.4816	Inconel 625 2.4856	Hastelloy-C 2.4610 / 2.4819	Monel 2.4360	Cunifer 30 2.0882	Tombac	Bronze	Copper	Nickel	Titanium	Tantalum	Aluminium	Silver
%	°C																				
<b>Mixed acids</b>																					
HNO <sub>3</sub>	H <sub>2</sub> SO <sub>4</sub>	H <sub>2</sub> O																			
%	%	%																			
90	10	-	20	0	0	0				3			3	3	3	3	0		1	3	
50	50	-	20		0	0											0			3	
50	50	-	90		3	1	1														
50	50	-	120		3	3	3														
38	60	2	50		3	0	0														
25	75	-	50		3	1	0														
25	75	-	90		3	3	1														
25	75	-	157		3	3	3														
15	20	65	20	3	3	0	0														
15	20	65	80		3	1	0														
10	70	20	50		3	0	0														
10	70	20	90		3	1	0														
5	30	65	20	3	3	0	0														
5	30	65	90	3	3	0	0														
5	30	65	bp	3	3	3	1														
5	15	80	134		3	1	1														
<b>Molasses</b>			0	0	0	0	0	0	0	0	0			0	0	0	0				
<b>Monochloroacetic acid</b>																					
s. Acetic acid																					
<b>Naphthalene</b>			100	20	0	0	0	0										0		1	
C <sub>10</sub> H <sub>8</sub>			100	390	0	0	0	0													
<b>Naphthalene chloride</b>			100	45							0										
			100	200						0											
<b>Naphthalene sulphonic acid</b>			100	20	0	0	0			0											
C <sub>10</sub> H <sub>7</sub> SO <sub>3</sub> H			100	bp	3	3	3			0											
<b>Naphthenic acid</b>			100	20	P	P	P	0	0	0	0	0				1				0	
<b>Nickel (II) chloride</b>			hy	10	20	3	P	P	P	0	1	0	0	1	1	3	1	3	1	0	0
NiCl <sub>2</sub>			hy	10	bp	3	P	P	P	0	0	0	0						0		
			total	70						1											
<b>Nickel (II) nitrate</b>			hy	10	25	3	0	0	0	0	0	0	0	3	3		3	3	0	0	3
Ni(NO <sub>3</sub> ) <sub>2</sub>			hy	<100	25	3	0	0	0	0	3	1	3				3	3	0	0	3

Medium			Materials																		
Designation Chemical formula		Concentration Temperature	Stainless steels			Nickel alloys				Copper alloys			Pure metals								
			%	°C	Non-/low- alloy steels			Incoloy 825 2.4858	Inconel 600 2.4816	Inconel 625 2.4856	Hastelloy-C 2.4610 / 2.4819	Monel 2.4360	Cunifer 30 2.0882	Tombac	Bronze	Copper	Nickel	Titanium	Tantalum	Aluminium	Silver
					Ferritic steels	Austenitic steels	Austenitic + Mo														
Nickel (II) sulphate NiSO <sub>4</sub>	hy	20	3	0	0	0															
	hy	bp	3	0	0	0															
Nitric acid HNO <sub>3</sub>	1	20	3	0	0	0			0	0	1	3	3	3	0	0	0				
	1	bp	3	0	0	0			1	3					3	0	0				
	5	20	3	0	0	0	0	3	0	3	3			3	3	0	0	0	3		
	5	bp	3	1	0	0			1							0	0				
	10	bp	3	1	0	0			1	3					3	0	0				
	15	bp	3	1	0	0			3							0	0				
	25	bp	3	3	0	0			3							1	0				
	50	bp	3	3	3	1	0	3	3	3	3			3	3	1	0	3			
	65	20	3	0	0	0		0	0							0	0	1			
	65	bp	3	3	3	3	0	3	3	3	3			3	3	0	0	3			
	99	bp	3	3	3	3	0	3	3	3	3			3	3	0	3				
	20	290	3	3	3	3			3							3	0				
40	200	3	3	3	3			3							3	0					
Nitrobenzene C <sub>6</sub> H <sub>5</sub> (NO <sub>2</sub> ) <sub>1</sub>			0	0	0	0	0	0	1	0	0	0	0	0	0	0				0	
Nitrobenzoic acid C <sub>6</sub> H <sub>4</sub> (NO <sub>2</sub> )COOH	hy	20	1	0	0	0	0	0	0	0	0	0	0	0	0					0	
Nitrogen N	100	20	0		0	0		0	0	0	0	0	0	0	0	0	0	0	0	0	
	100	900	1												3						
Nitroglycerine C <sub>3</sub> H <sub>5</sub> (ONO <sub>2</sub> ) <sub>3</sub>		20	0	0	0	0														0	
Nitrous acid HNO <sub>2</sub> similar to Nitric acid																					
Oil of turpentine	100	20	3	0	0	0					0	1	0	0		0	0			0	
	100	bp	3	0	0	0					0	1	0	0		0	0			0	
Oleic acid s. Fatty acid																					
Oleum s. Sulphur trioxide																					
Oxalic acid C <sub>2</sub> H <sub>2</sub> O <sub>4</sub>	hy	All	3	3	0	0	1	1	0	0	1				3	0	0	0	0		
	hy	10	3	3	3	3	0	1	0	0	1	1		1	3	3	0	3			
	hy		3	3	3	3	1	1	1	1	1										
	sa																				



Medium		Materials																									
Designation Chemical formula		Concentration %	Temperature °C	Stainless steels			Nickel alloys				Copper alloys			Pure metals													
				Non-/low- alloy steels	Ferritic steels	Austenitic steels	Austenitic + Mo	Incoloy 825	2.4858	Inconel 600	2.4816	Inconel 625	2.4856	Hastelloy-C	2.4610 / 2.4819	Monel	2.4360	Cunifer 30	2.0882	Tombac	Bronze	Copper	Nickel	Titanium	Tantalum	Aluminium	Silver
Oxygen			500	1	0	0	0						0						3	3					0	3	
O																											
Ozone					0	0	0	0	0	0	0	0	0	0						1		0			0		
Paraffin			20	0	0	0	0															0			0		
CnH <sub>2n-2</sub>	me		120	0	0	0	0									0	0	0	0			0			0		
Perchloric acid		10	20	3	3	3	3															0			3		
HClO <sub>4</sub>		100	20	3	3	3	3															0					
Perchloroethylene			20	0	0	0	0									0	0	0	0						0		
C <sub>2</sub> Cl <sub>4</sub>			bp	0	1	1	1								1	1	0	0							3		
	mo			3	P	P	P																				
Perhydrop																											
s. Hydrogen peroxide																											
Petrol <sup>1)</sup>		100	25	1	0	0	0	0	0	0	0	0	0	1	1	0	0	0	0	0	0	1			1		
		100	bp	1			0	0				0	1									1			1		
Petroleum			20	0	0	0	0		0	0	0	0	0	0	1	0	0	0	0	0	0	0			0		
			bp	0	0	0	0		0	0	0	0	0	1	0	0	0	3	0			0			0		
Phenol																											
s. Carboric acid																											
Phloroglucinol																						0	0		0		
C <sub>6</sub> H <sub>3</sub> (OH) <sub>3</sub>			20		0	0	0	0	0	0	0	0	0														
Phosgene	dr																										
COCl <sub>2</sub>			20		0	0	0	0	0	0	0	0	0									0	0		0		
Phosphoric acid	hy	1	20	3	0	0	0	0	0	0	0	1	3						3	0	0	0	0	0	3		
H <sub>3</sub> PO <sub>4</sub>	hy	10	20	3	3	0	0				0											0			0		
	hy	30	bp	3	3	1	1				1	1	1	2	1	3	3	3	3	0	3	0	0	3			
	hy	60	bp	3	3	3	3				1											3	0				
	hy	80	20	3	3	1	0		0	0	0				0	1						3	0		0		
	hy	80	bp	3	3	3	3		0	0	3				1							3	3	0	1		
Phosphorous	dr																										
P			20	0	0	0	0																				
Phosphorous pentachloride	dr																										
PCI <sub>5</sub>		100	20	0	0	0					0								0	1							
Phthalic acid and phthalic anhydride			20	0	0	0				0	0		0	0	0	0	0	0	0	0				0	0		
C <sub>6</sub> H <sub>4</sub> (COOH) <sub>2</sub>	dr		200		0	3	0			0	0														0		
			bp		0	0	0																		0		

1) Worst rating from "Corrosion Data Survey" (NACE, 1967) and "Compass Corrosion Guide II" (Kenneth M. Pruett, 1983)

Medium				Materials																		
Designation	Chemical formula	Concentration	Temperature	Stainless steels			Nickel alloys				Copper alloys			Pure metals								
				Non-/low- alloy steels	Ferritic steels	Austenitic steels	Austenitic + Mo	Incoloy 825 2.4858	Inconel 600 2.4816	Inconel 625 2.4856	Hastelloy-C 2.4610 / 2.4819	Monel 2.4360	Cunifer 30 2.0882	Tombac	Bronze	Copper	Nickel	Titanium	Tantalum	Aluminium	Silver	
																						%
Picric acid $C_6H_2(OH)(NO_2)_3$	hy	3	20	3	0	0	0												0	1	0	
	hy	cs		3	0	0	0	3	3										0	0	0	
	me		150	3	0	0	0												0	0	3	
Plaster see Calcium sulphate																						
Potassium K	me		604	0	0	0			1										0	0		
			80		0	0			1										0	1	0	
Potassium acetate $CH_3COOK$	me	100	292	1		0	0							1				0				
	hy		20	1	0	0	0	0	0	0			1	1	0	0						
Potassium aluminium sulphate s. Alum																						
Potassium bisulphate $KHSO_4$	hy	5	20	3	3	2	0											0				
	hy	5	90	3	3	3	3											3				
Potassium bitartrate $KC_4H_5O_6$	hy	cs		3	3	0	0								0	0		0	0	0		
	hy	sa		3	3	3	1								1	0		0	0	0		
Potassium bromide KBr	hy	5	30	3	P	P	P	0	1	0	0	1	0	0	0	0	0	0	0	0	3	
Potassium carbonate $K_2CO_3$	hy	50	20	1	0	0	0	0	0	0	0	1	3	1	1	0	0	0	0	3	0	
	hy	50	bp	3	3	0	0	0	0	0	0	0	3			0	0	0	0	3	0	
Potassium chlorate $KClO_3$	hy	5	20	3	0	0	0	0	1	0		1	3	1	1	1	0		0			
	hy			3	0	0	0	0	3	0	0	3	3		1	3	0	0	0	1		
	sa																					
Potassium chloride KCl	hy	10	20	3	3	P	P	0	0	0	0	0	0							1		
	hy	10	<bp	3	3	P	P					1	3							1		
	hy	30	bp	3	3	P	P					1	0	3	1	3		0		0	0	
	hy	cs		3	P	P	P					1										
	hy	sa		3	3	P	P					1										
Potassium chromate $K_2CrO_4$	hy	10	20	0		0	0	0	0	0	0	1	0	0	0	0	0	0	0	0	0	
	hy	10	bp	1		0	0											0	0	0	0	
Potassium cyanide KCN	hy	10	20	3	0	0	0	0	3		0	1	3	3	3	3			0	3		
	hy	10	bp	3	0	0	0						3	3	3	3				3	3	



Medium			Materials																	
Designation Chemical formula		Concentration Temperature	Non-/low- alloy steels	Stainless steels			Nickel alloys				Copper alloys			Pure metals						
				Ferritic steels	Austenitic steels	Austenitic + Mo	Incoloy 825 2.4858	Inconel 600 2.4816	Inconel 625 2.4856	Hastelloy-C 2.4610 / 2.4619	Monel 2.4360	Cunifer 30 2.0882	Tombac	Bronze	Copper	Nickel	Titanium	Tantalum	Aluminium	Silver
Potassium sulphate K <sub>2</sub> SO <sub>4</sub>	hy hy	10 All	25 bp	3 0	0 0	0 0	0 0	0 0	0 0	0 0	0 0	0 0	0 0	0 0	0 0	0 0	0 0	0 1		
Propionic acid s. Acetic acid																				
Protein solutions			20	1	0	0	0	0	0	0	0	0				0	0	0		
Prussiate of potash s. Potassium ferricyanide																				
Prussic acid s. Hydrogen cyanide																				
Pyridine C <sub>5</sub> H <sub>5</sub> N	dr	All	20 bp		0 0	0 0	0 0		0 0	0 0	0 0					0 0	0 0	0 0		
Pyrogallol C <sub>6</sub> H <sub>3</sub> (OH) <sub>3</sub>		All	20 bp	3 3	0 0	0 0	0 0		0 0	0 0	0 0			0 0		0 0	0 0	0 0		
Quinine bisulphate	dr		20	3	3	3	0	0	0	0	1	0			0	0	0	0		
Quinine sulphate	dr		20	3	0	0	0	0	0	0	1	0			0	0	0	0		
Salicylic acid HOOC <sub>6</sub> H <sub>4</sub> COOH	dr mo hy	100 100 cs	20 20	1 3	0 0	0 0	0 0	0 1	0 0	0 0	1 0	0 0			0 0	1 0	0 0	0 1		
Saltpetre s. Potassium nitrate																				
Seawater at flow rate (v): v<1.5m/s 1.5<v<4.5m/s			20 20	1 1	P 0	P 0	P 0	0 0	P 0	0 0	0 0	P 0	1 0		0 0	1 3	P 1			
Silver nitrate AgNO <sub>3</sub>	hy hy hy me	10 10 20 40 100	20 bp 60 20 250	3 3 3 3	0 0 0 0	0 0 0 0	0 0 0 0	1 1 1 1	1 1 1 1	1 1 1 1	3 3 3 3	3 3 3 3	3 3 3 3	3 3 3 3	0 0 0 0	0 0 0 0	3 0 0 0			
Soap	hy hy hy	1 1 10	20 75 20	0 0 0	0 0 0	0 0 0	0 0 0	0 0 0	0 0 0	0 0 0	0 0 0	1 0 0	0 0 0	0 0 0	0 0 0	0 0 0	0 0 0	0 0 0		
Sodium Na	me		200 600	0 3	0 1	0 0	0 0								0 0	1 0				

Medium				Materials																
Designation Chemical formula		Concentration %	Temperature °C	Non-/low-alloy steels																
				Stainless steels			Nickel alloys				Copper alloys			Pure metals						
				Ferritic steels	Austenitic steels	Austenitic + Mo	Incoloy 825 2.4858	Inconel 600 2.4816	Inconel 625 2.4856	Hastelloy-C 2.4610 / 2.4819	Monel 2.4360	Cunifer 30 2.0882	Tombac	Bronze	Copper	Nickel	Titanium	Tantalum	Aluminium	Silver
Sodium acetate CH <sub>3</sub> -COONa	hy	10	25	0	0	0	0	0	0	0	0	0	0	0	0	0	0	0	0	
	hy			3	0	0	0													
	sa																			
Sodium aluminate Na <sub>2</sub> AlO <sub>3</sub>	hy	100	20	0	0	0	0											0	0	
	hy	10	25	0	0	0	0			1								0	3	
Sodium arsenate Na <sub>2</sub> HAsO <sub>4</sub>	hy	cs		0	0	0	0											0	0	
Sodium bicarbonate NaHCO <sub>3</sub>	hy	100	20	0	0	0	0											0	0	
	hy	10	20	0	0	0	0	0	1	1	1	1	0	3	1	1	1	0	0	
	hy	cs		0	0	0	0	0	1	0	0	1	0			0	1	0	1	
	hy	sa		0	0	0	0			1							0			
Sodium bisulphate NaHSO <sub>4</sub>	hy	All	20	3	3	3	0	0	1	1	1	1	3	3	1	1	1	0	0	0
	hy	All	bp	3	3	3	1	0	1	1	1	1	3	3	1	3	1	0	0	1
Sodium bisulphite NaHSO <sub>3</sub>	hy	10	20	3	3	0	0				1				1	0	3	0	0	0
	hy	50	20	3	0	0	0				1	0			1	0	3	0	0	
	hy	50	bp	3	3	3	0				0	0					0	0	0	
Sodium borate Na <sub>2</sub> B <sub>4</sub> O <sub>7</sub> · 10 H <sub>2</sub> O (Borax)	hy	cs		0	0	0	0		0	0	1	0				0		0	0	1
Na <sub>2</sub> B <sub>4</sub> O <sub>7</sub> · 10 H <sub>2</sub> O (Borax)	me			3	3	3	3				3									
Sodium bromide NaBr	hy	All	20	3	3	3	P				1							0	3	
	hy	All	bp	3	3	3	P				1							0	3	
Sodium carbonate Na <sub>2</sub> CO <sub>3</sub>	hy	1	20	3	0	0	0	0	0	1	0	0	0	0			0	0	0	2
	hy	All	bp	0	0	0	0	0	0	0	0						0	0	0	3
	hy	400		3	3	3	3													
	me	900		3	3	3	3					0					0			
Sodium chloride NaCl	hy	0.5	20		P	P	P	0	1	0	0	0	0				1	0	0	
	hy	2	20		P	P	P	0	1	0	0	0	0				1	0	0	
	hy	cs		3	P	P	P	0	1	0	0	0	0				0	1	0	2
	hy	sa		3	3	3	P	0	1	0	1	0	0				0	1	0	3
Sodium chlorite NaClO <sub>2</sub>	dr	100	20	3	P	P	0		0									0		
	hy	5	20			3	P											0		
	hy	5	bp			3	3				1							0		
	hy	10	80	3		3	P		0		1							0		
Sodium chromate Na <sub>2</sub> CrO <sub>4</sub>	hy	All	bp	0	0	0	0	0	0	0	0	0	0	0	0	0			0	



Medium				Materials																					
Designation Chemical formula		Concentration %	Temperature °C	Non-/low-alloy steels																					
				Stainless steels			Nickel alloys				Copper alloys			Pure metals											
				Ferritic steels	Austenitic steels	Austenitic + Mo	Incoloy 825 2.4858	Inconel 600 2.4816	Inconel 625 2.4856	Hastelloy-C 2.4610 / 2.4819	Monel 2.4360	Cunifer 30 2.0882	Tombac	Bronze	Copper	Nickel	Titanium	Tantalum	Aluminium	Silver					
Sodium nitride NaNO <sub>2</sub>	hy		20		0	0	1	0	0	0	0	0	0												
Sodium perborate NaBO <sub>2</sub>	hy	10	20	3	0	0	0				1														
	hy	10	bp	3	0	0	0				1														
Sodium perchlorate NaClO <sub>4</sub>	hy	10	20	3	3	0	0	1			1														
	hy	10	bp	3	0	0	0	1			1														
Sodium peroxide Na <sub>2</sub> O <sub>2</sub>	hy	10	20	3	1	0	0	1	1	1	1	0	3												
	hy	10	bp	3	3	0	0	1	1	1	1	0	3												
	me		460					3	1		3	3													
Sodium phosphate Na <sub>2</sub> HPO <sub>4</sub>	hy	10	20		0	0	0	0	0	0	0	0	0	3	1										
	hy	10	bp		0	0	0	0	0	0	0	0	0												
	hy	cs			0	0	0	0	0	0	0	0	0												
Sodium silicate C <sub>6</sub> H <sub>4</sub> (OH)COONa	hy	All	20		0	0	0	0			0														
Sodium silicofluoride Na <sub>2</sub> (SiF <sub>6</sub> )	hy	cs		3	3	3	3	0	0	1	1	0													1
Sodium sulphate Na <sub>2</sub> SO <sub>4</sub>	hy	10	20	3	0	0	0	0	0	0	0	0	0	0	0	0	0	0	0	0	0	0	0	0	0
	hy	cs		3	1	0	0	0	1	0	0	1	0												
	hy			3	3	0	0	0	0	0	0	0													1
		sa																							
Sodium sulphide Na <sub>2</sub> S	hy	1	20	3	0	0	0	0	0			1													
	hy	cs	20	3	3	3	0	0	1	0	0		3												1
	hy			3	3	3	1																		3
		sa																							
Sodium sulphite Na <sub>2</sub> SO <sub>3</sub>	hy	10	20	3	1	0	0					0	1	3	1	1									0
	hy	50	bp	3	3	0	0																		3
Sodium superoxide s. Sodium peroxide																									
Sodium thiosulphate Na <sub>2</sub> S <sub>2</sub> O <sub>3</sub>	hy	1	20	1	0	0	0					0													0
	hy	10	20	3	0	0	0																		0
	hy	25	bp	3	P	P	P																		1
	cs			3	3	0	0			1		1	3												0
Stearic acid CH <sub>3</sub> (CH <sub>2</sub> ) <sub>16</sub> COOH		100	20	1	0	0	0	0	0	0	0	0	1	3	1	1	0	0	0	0	0	0	0	0	0
		100	95	3	0	0	0	0	1		0	1	1				0	1	0	0	0	0	3		
		100	180								1						0								3

Medium			Materials																	
Designation Chemical formula		Concentration Temperature	Stainless steels			Nickel alloys				Copper alloys			Pure metals							
			Non-/low- alloy steels	Ferritic steels	Austenitic steels	Austenitic + Mo	Incoloy 825 2.4858	Inconel 600 2.4816	Inconel 625 2.4856	Hastelloy-C 2.4610 / 2.4819	Monel 2.4360	Cunifer 30 2.0882	Tombac	Bronze	Copper	Nickel	Titanium	Tantalum	Aluminium	Silver
Succinic acid C <sub>4</sub> H <sub>6</sub> O <sub>4</sub>		bp	1	0	0	0	0	0	0	0	0	0	0	0	0	0	0	0	0	0
Sulphur S	dr	100	60	0	0	0	0	0	0	0	0	0	0	0	0	0	0	0	0	3
	me		130	1	0	0	0	0	0	3	3	3	3	3	3	3	0	0	0	3
	me		240	3	0	0	0	0	0	0	0	0	0	3	3	0	0	0	0	3
	mo		20	3	2	1	0	0	0	3	3	3	3	3	3	0	0	0	0	3
Sulphur dioxide SO <sub>2</sub>	dr	100	20	0	0	0	0	0	0	1	0	0	0	0	0	0	0	0	0	0
	dr	100	60	3	3	1	1	0	0	0	0	0	0	0	0	0	0	0	0	0
	dr	100	400	3	3	3	0	0	1	0	3	0	0	0	0	0	0	0	3	
	dr	100	800	3	3	3	3	0	3	0	0	0	3	0	0	0	0	0	0	
	mo	100	20	3	3	3	0	0	0	0	3	3	1	3	0	0	0	0	3	
	mo	100	60	3	3	3	0	0	0	0	0	0	0	0	0	0	0	0	3	
	mo	100	70	3	3	3	3	0	0	0	0	0	0	0	0	0	0	0	3	
Sulphur trioxide SO <sub>3</sub>	mo	100	20																	3
	dr	100	20	0				2	3	0	3	2	0	0	0	3		3	0	0
Sulphuric acid H <sub>2</sub> SO <sub>4</sub>	0.05	20	3	1	0	0										0	0	1		
	0.05	bp	3	1	1	0										1	0	3		
	0.1	20	3	3	0	0										0	0	1		
	0.2	bp	3	3	3	0										1	0	3		
	0.8	bp	3	3	3	3										1	0	3		
	1	20	3	3	1	0		1	0	0	1	3			1	0	0	1		
	3	bp	3	3	3	3		1	1	1	3	3			1	1	0	3		
	5	bp	3	3	3	3	1	3	3	3	1	3			3	3	3	0	3	
	7.5	20	3	3	1	0										1	0	1		
	10	bp	3	3	3	3	1	3	3	3	3	3			3	3	3	0	3	
	25	20	3	3	3	3			0	0	3	3				3	0	1		
	25	bp	3	3	3	3			3	3	3	3				3	0	3		
	40	20	3	3	3	3			0	1	3	3	3	3	3	1	0	1		
	40	bp	3	3	3	3			3	3	3	3				3	0	3		1
	50	20	3	3	3	3	1	3	0	0	3	3			3	3	3	0	3	
	50	bp	3	3	3	3	3	3	3	3	3	3			3	3	3	0	3	
	60	20	3	3	3	3			0	1	3	3	3	3	3	0	3	0	3	
80	20	3	3	1	1			0	1	3	3	3	1	1	3	0	3			
90	20	3	3	1	0			0	0	0	0				3	0	3			
96	20	1	1	1	0			0	3	3	3			1	1	3	0	3		3



Medium				Materials																	
Designation Chemical formula		Concentration %	Temperature °C	Non-/low-alloy steels				Stainless steels				Nickel alloys				Copper alloys			Pure metals		
				Ferritic steels	Austenitic steels	Austenitic + Mo	Incoloy 825 2.4858	Inconel 600 2.4816	Inconel 625 2.4856	Hastelloy-C 2.4610 / 2.4819	Monel 2.4360	Cunifer 30 2.0882	Tombac	Bronze	Copper	Nickel	Titanium	Tantalum	Aluminium	Silver	
Sulphurous acid H <sub>2</sub> SO <sub>3</sub>	hy	1	20	3	3	0	0	0	0	1	0	0	0	0	0	0	0	1			
	hy	cs		3	3	0	0				0	3						0			
	hy	sa		3	3	1	0				1							0			
Tannic acid C <sub>76</sub> H <sub>52</sub> O <sub>46</sub>	hy	5	20	3	0	0	0	0	0	0	0	0	1	0	0	0	0	0			
	hy	25	100	3	3	0	0	0	0									0			
	hy	50	bp	3	3	0	0					0						0			
Tannin s. Tannic acid																					
Tar			20	0	0	0	0					0	1	0	0	0		1			
Tartaric acid	hy	10	20	1	0	0	0	0	1	0	0	1	0	3	0	1	0	0			
	hy	10	bp	3	1	0	0	0	3	0	1	3	0	3	0	3	1	0			
	hy	25	20	3	1	0	0	0	0	0	0	0	0		0	1	0				
	hy	25	bp	3	3	1	0	0	0	0	1	1	0		1	0	0				
	hy	50	20	3	3	0	0	0	0	0	0	0	0		0	0	0				
	hy	50	bp	3	3	3	3	0	1	0	1	0	0		3	0	0				
	hy	5	20	3	P	P	P	0	1	0	0	1	3		1	0	0				
Tetrachloroethane s. Carbon tetrachloride																					
Tin chloride SnCl <sub>2</sub> ; SnCl <sub>4</sub>	sa			3	3	3	3														
	All	<80		3	3	0	0	0	0	0	0										
Toluene C <sub>6</sub> H <sub>5</sub> -CH <sub>3</sub>	100	20		0	0	0	0				0	0	0	0	0	0	0				
	100	bp		0	0	0	0				0	0	0	0	0	0	0				
Trichloroacetaldehyde s. Chloral																					
Trichloroacetic acid s. Chloroacetic acid																					
Trichloroethylene CHCl=CCl <sub>2</sub>	pure	100	20	0	0	0	0			0	0	0	0	0	0	0	0				
	pure	100	bp			0	0			0	0	0	0	0	0	0	0				
	mo		20	3	3	P	P			0	1	3	1	1	0	0	3				
	mo		bp	3	3	P	P			0	1	3	1	1	0	0	3				
Trichloromethane s. Chloroform																					
Tricresyl phosphate				0	0	0	0	0	0	0	0	0	0	0	0	0	0				



# PIPES. FLANGES. PIPE BENDS



In chapter 19 you can find the dimensions of flanges and pipe bends as well as seamless and welded steel pipes.

# SEAMLESS AND WELDED STEEL PIPES

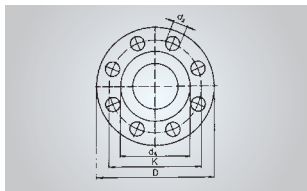
DIN EN 10220. edition 03.2003 (extract). weights and measures

Nominal diameter	Outside diameter	masses (weights) in relation to length in kg/m wall thickness in mm											
		1.6	1.8	2	2.3	2.6	2.9	3.2	3.6	4	4.5	5	5.6
DN	mm												
6	10.2	0.339	0.373	0.404	0.448	0.487							
8	13.5	0.470	0.519	0.567	0.635	0.699	0.758	0.813					
10	17.2	0.616	0.684	0.750	0.845	0.936	1.02	1.10	0.879	1.30	1.41		
15	21.3	0.777	0.866	0.952	1.08	1.20	1.32	1.43	1.21	1.71	1.86	2.01	
20	26.9	0.998	1.11	1.23	1.40	1.56	1.72	1.87	1.57	2.26	2.49	2.70	2.94
25	33.7	1.270	1.42	1.56	1.78	1.99	2.20	2.41	2.07	2.93	3.24	3.54	3.88
32	42.4	1.610	1.80	1.99	2.27	2.55	2.82	3.09	2.67	3.79	4.21	4.61	5.08
40	48.3	1.840	2.06	2.28	2.61	2.93	3.25	3.56	3.44	4.37	4.86	5.34	5.90
50	60.3	2.320	2.60	2.88	3.29	3.70	4.11	4.51	3.97	5.55	6.19	6.82	7.55
65	76.1	2.940	3.30	3.65	4.19	4.71	5.24	5.75	5.03	7.11	7.95	8.77	9.74
80	88.9	3.440	3.87	4.29	4.91	5.53	6.15	6.76	6.44	8.38	9.37	10.3	11.5
100	114.3	4.450	4.99	5.54	6.35	7.16	7.97	8.77	7.57	10.9	12.2	13.5	15.0
125	139.7	5.450	6.12	6.79	7.79	8.79	9.78	10.8	9.83	13.4	15.0	16.6	18.5
150	168.3	6.580	7.39	8.20	9.42	10.6	11.8	13.0	12.1	16.2	18.2	20.1	22.5
200	219.1		9.65	10.7	12.3	13.9	15.5	17.0	14.6	21.2	23.8	26.4	29.5
250	273.0			13.4	15.4	17.3	19.3	21.3	19.1	26.5	29.8	33.0	36.9
300	323.9					20.6	23.0	25.3	23.9	31.6	35.4	39.3	44.0
350	355.6					22.6	25.2	27.8	28.4	34.7	39.0	43.2	48.3
400	406.4					25.9	28.9	31.8	31.3	39.7	44.6	49.5	55.4
450	457							35.8	35.8	44.7	50.2	55.7	62.3
500	508							39.8	40.3	49.5	55.9	62.0	69.4
600	610							47.9	44.8	59.8	67.2	74.6	83.5
700	711								53.8	69.7	78.4	87.1	97.4
800	813									79.8	89.7	99.6	112
900	914									89.8	101	112	125
1000	1016									99.8	112	125	140

Nominal diameter	Outside diameter	masses (weights) in relation to length in kg/m wall thickness in mm												
		6.3	7.1	8	8.8	10	11	12.5	14.2	16	17.5	20	22.2	
6	10.2													
8	13.5													
10	17.2													
15	21.3													
20	26.9	3.20	3.47	3.73										
25	33.7	4.26	4.66	5.07	5.40									
32	42.4	5.61	6.18	6.79	7.29	7.99								
40	48.3	6.53	7.21	7.95	8.57	9.45	10.1	11.0						
50	60.3	8.39	9.32	10.3	11.2	12.4	13.4	14.7	16.1	17.5				
65	76.1	10.8	12.1	13.4	14.6	16.3	17.7	19.6	21.7	23.7	25.3	27.7		
80	88.9	12.8	14.3	16.0	17.4	19.5	21.1	23.6	26.2	28.8	30.8	34.0	36.5	
100	114.3	16.8	18.8	21.0	22.9	25.7	28.0	31.4	35.1	38.8	41.8	46.5	50.4	
125	139.7	20.7	23.2	26.0	28.4	32.0	34.9	39.2	43.9	48.8	52.7	59.0	64.3	
150	168.3	25.2	28.2	31.6	34.6	39.0	42.7	48.0	54.0	60.1	65.1	73.1	80.0	
200	219.1	33.1	37.1	41.6	45.6	51.6	56.5	63.7	71.8	80.1	87.0	98.2	108	
250	273.0	41.4	46.6	52.3	57.3	64.9	71.1	80.3	90.6	101	110	125	137	
300	323.9	49.3	55.5	62.3	68.4	77.4	84.9	96.0	108	121	132	150	165	
350	355.6	54.3	61.0	68.6	75.3	85.2	93.5	106	120	134	146	166	183	
400	406.4	62.2	69.9	78.6	86.3	97.8	107	121	137	154	168	191	210	
450	457	70.0	78.8	88.6	97.3	110	121	137	155	174	190	216	238	
500	508	77.9	87.7	98.6	108	123	135	153	173	194	212	241	266	
600	610	93.8	106	119	130	148	162	184	209	234	256	291	322	
700	711	109	123	139	152	173	190	215	244	274	299	341	377	
800	813	125	141	159	175	198	218	247	280	314	343	391	433	
900	914	141	159	179	196	223	245	278	315	354	387	441	488	
1000	1016	157	177	199	219	248	273	309	351	395	431	491	544	

# FLANGES

DIN EN 1092: Edition December 2018 (extract)



DIN EN 1092	
Outside diameter	D
Raised face diameter	$d_1$
Bolt circle diameter	K
Bolt hole diameter	L

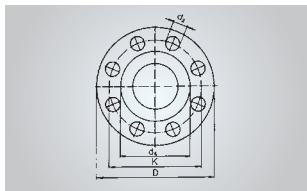
Nominal diameter	Nominal pressure 1 and 2.5						Nominal pressure 6						
	DN	D	$d_1$	K	bolts		D	$d_1$	K	bolts			
					number	thread	L				number	thread	L
10	connection dimensions see nominal pressure 6	75	35	50	4	M 10	11						
15		80	40	55	4	M 10	11						
20		90	50	65	4	M 10	11						
25		100	60	75	4	M 10	11						
32		120	70	90	4	M 12	14						
40		130	80	100	4	M 12	14						
50		140	90	110	4	M 12	14						
65		160	110	130	4	M 12	14						
80		190	128	150	4	M 16	18						
100		210	148	170	4	M 16	18						
125		240	178	200	8	M 16	18						
150		265	202	225	8	M 16	18						
200		320	258	280	8	M 16	18						
250		375	312	335	12	M 16	18						
300		440	365	395	12	M 20	22						
350		490	415	445	12	M 20	22						
400		540	465	495	16	M 20	22						
450		595	520	550	16	M 20	22						
500		645	570	600	20	M 20	22						

Nominal diameter	Nominal pressure 1 and 2.5						Nominal pressure 6					
	DN	D	d <sub>1</sub>	K	bolts		D	d <sub>1</sub>	K	bolts		L
					number	thread				number	thread	
600	connection dimensions see nominal pressure 6						755	670	705	20	M 24	26
700							860	775	810	24	M 24	26
800							975	880	920	24	M 27	30
900							1075	980	1020	24	M 27	30
1000							1175	1080	1120	28	M 27	30
1200	1375	1280	1320	32	M 27	30	1405	1295	1340	32	M 30	33
1400	1575	1480	1520	36	M 27	30	1630	1510	1560	36	M 33	36
1600	1790	1690	1730	40	M 27	30	1830	1710	1760	40	M 33	36
1800	1990	1890	1930	44	M 27	30	2045	1920	1970	44	M 36	39
2000	2190	2090	2130	48	M 27	30	2265	2125	2180	48	M 39	42
2200	2405	2295	2340	52	M 30	33	2475	2335	2390	52	M 39	42
2400	2605	2495	2540	56	M 30	33	2685	2545	2600	56	M 39	42
2600	2805	2695	2740	60	M 30	33	2905	2750	2810	60	M 45	48
2800	3030	2910	2960	64	M 33	36	3115	2960	3020	64	M 45	48
3000	3230	3110	3160	68	M 33	36	3315	3160	3220	68	M 45	48
3200	3430	3310	3360	72	M 33	36	3525	3370	3430	72	M 45	48
3400	3630	3510	3560	76	M 33	36	3735	3580	3640	76	M 45	48
3600	3840	3770	3770	80	M 33	36	3970	3790	3860	80	M 52	56
3800	4045	3970	3970	80	M 36	39	no flanges					
4000	4245	4120	4170	84	M 36	39						



# FLANGES

DIN EN 1092: Edition December 2018 (extract)



DIN EN 1092	
Outside diameter	D
Raised face diameter	$d_1$
Bolt circle diameter	K
Bolt hole diameter	L

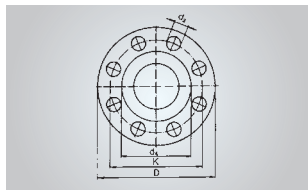
Nominal diameter	Nominal pressure 10						Nominal pressure 16					
	DN		D	$d_1$	K	bolts		D	$d_1$	K	bolts	
		number				thread	L				number	thread
6	connection dimensions see nominal pressure 40						connection dimensions see nominal pressure 40					
8												
10												
15												
20												
25												
32												
40												
50												
65												
80	connection dimensions see nominal pressure 16						220	158	180	8	M 16	18
100							250	188	210	8	M 16	18
125							285	212	240	8	M 20	22
150							285	212	240	8	M 20	22
200	340	268	295	8	M 20	22	340	268	295	12	M 20	22
250	395	320	350	12	M 20	22	405	320	355	12	M 24	26
300	445	370	400	12	M 20	22	460	378	410	12	M 24	26
350	505	430	460	16	M 20	22	520	438	470	16	M 24	26
400	565	482	515	16	M 24	26	580	490	525	16	M 27	30
450	615	532	565	20	M 24	26	640	550	585	20	M 27	30
500	670	585	620	20	M 24	26	715	610	650	20	M 30	33

4 screws are permitted if agreed

Nominal diameter	Nominal pressure 10						Nominal pressure 16						
	DN	D	d <sub>1</sub>	K	bolts			D	d <sub>1</sub>	K	bolts		
					number	thread	L				number	thread	L
600	780	685	725	20	M 27	30	840	725	770	20	M 33	36	
700	895	800	840	24	M 27	30	910	795	840	24	M 33	36	
800	1015	905	950	24	M 30	33	1025	900	950	24	M 36	39	
900	1115	1005	1050	28	M 30	33	1125	1000	1050	28	M 36	39	
1000	1230	1110	1160	28	M 33	36	1255	1115	1170	28	M 39	42	
1200	1455	1330	1380	32	M 36	39	1485	1330	1390	32	M 45	48	
1400	1675	1535	1590	36	M 39	42	1685	1530	1590	36	M 45	48	
1600	1915	1760	1820	40	M 45	48	1930	1750	1820	40	M 52	56	
1800	2115	1960	2020	44	M 45	48	2130	1950	2020	44	M 52	56	
2000	2325	2170	2230	48	M 45	48	2345	2150	2230	48	M 56	62	
2200	2550	2370	2440	52	M 52	56	no flanges						
2400	2760	2570	2650	56	M 52	56							
2600	2960	2780	2850	60	M 52	56							
2800	3180	3000	3070	64	M 52	56							
3000	3405	3210	3290	68	M 56	62							
3200	no flanges												
3400													
3600													
3800													
4000													

# FLANGES

DIN EN 1092: Edition December 2018 (extract)



	DIN EN 1092
Outside diameter	D
Raised face diameter	$d_1$
Bolt circle diameter	K
Bolt hole diameter	L

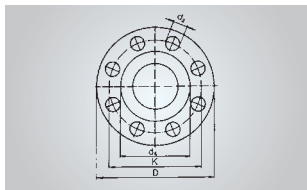
Nominal diameter	Nominal pressure 25						Nominal pressure 40						
	DN	D	$d_1$	K	bolts		D	$d_1$	K	bolts			
					number	thread	L				number	thread	L
6								75	32	50	4	M 10	11
8								80	38	55	4	M 10	11
10								90	40	60	4	M 12	14
15								95	45	65	4	M 12	14
20								105	58	75	4	M 12	14
25								115	68	85	4	M 12	14
32								140	78	100	4	M 16	18
40								150	88	110	4	M 16	18
50								165	102	125	4	M 16	18
65								185	122	145	8	M 16	18
80								200	138	160	8	M 16	18
100								235	162	190	8	M 20	22
125								270	188	220	8	M 24	26
150								300	218	250	8	M 24	26
200	360	278	310	12	M 24	26	375	285	320	12	M 27	30	
250	425	335	370	12	M 27	30	450	345	385	12	M 30	33	
300	485	395	430	16	M 27	30	515	410	450	16	M 30	33	
350	555	450	490	16	M 30	33	580	465	510	16	M 33	36	
400	620	505	550	16	M 33	36	660	535	585	16	M 36	39	
450	670	555	600	20	M 33	36	685	560	610	20	M 36	39	
500	730	615	660	20	M 33	36	755	615	670	20	M 39	42	

connection dimensions see nominal pressure 40

Nominal diameter	Nominal pressure 25						Nominal pressure 40					
	bolts						bolts					
	D	d <sub>1</sub>	K	number	thread	L	D	d <sub>1</sub>	K	number	thread	L
600	845	720	770	20	M 36	39	890	735	795	20	M 45	48
700	960	820	875	24	M 39	42	995	840	900	24	M 45	48
800	1085	930	990	24	M 45	48	1140	960	1030	24	M 52	56
900	1185	1030	1090	28	M 45	48	1250	1070	1140	28	M 52	56
1000	1320	1140	1210	28	M 52	56	1360	1180	1250	28	M 52	56
1200	1530	1350	1420	32	M 52	56	1575	1380	1460	32	M 56	62
1400	1755	1560	1640	36	M 56	62	1795	1600	1680	36	M 56	62
1600	1975	1780	1860	40	M 56	62	2025	1815	1900	40	M 64	70
1800	2195	1985	2070	44	M 64	70	no flanges					
2000	2425	2210	2300	48	M 64	70						
2200	no flanges											
2400												
2600												
2800												
3000												
3200												
3400												
3600												
3800												
4000												

# FLANGES

DIN EN 1092: Edition December 2018 (extract)



	DIN EN 1092
Outside diameter	D
Raised face diameter	$d_1$
Bolt circle diameter	K
Bolt hole diameter	L

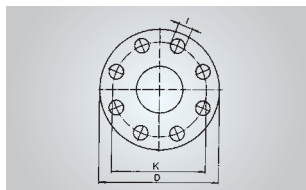
Nominal diameter	Nominal pressure 63						Nominal pressure 100						
	DN	D	$d_1$	K	bolts		D	$d_1$	K	bolts			
					number	thread	L				number	thread	L
10	Connection dimensions. see nominal pressure 100						100	40	70	4	M 12	14	
15							105	45	75	4	M 12	14	
20							130	58	90	4	M 16	18	
25							140	68	100	4	M 16	18	
32							155	78	110	4	M 20	22	
40							170	88	125	4	M 20	22	
50	180	102	135	4	M 20	22	195	102	145	4	M 24	26	
65	205	122	160	8	M 20	22	220	122	170	8	M 24	26	
80	215	138	170	8	M 20	22	230	138	180	8	M 24	26	
100	250	162	200	8	M 24	26	265	162	210	8	M 27	30	
125	295	188	240	8	M 27	30	315	188	250	8	M 30	33	
150	345	218	280	8	M 30	33	355	218	290	12	M 30	33	
200	415	285	345	12	M 33	36	430	285	360	12	M 33	36	
250	470	345	400	12	M 33	36	505	345	430	12	M 36	39	
300	530	410	460	16	M 33	36	585	410	500	16	M 39	42	
350	600	465	525	16	M 36	39	655	465	560	16	M 45	48	
400	670	535	585	16	M 39	42	715	535	620	16	M 45	48	
500	800	615	705	20	M 45	48	870	615	760	20	M 52	56	
600	930	735	820	20	M 52	56	-	-	-	-	-	-	

Nominal diameter	Nominal pressure 63						Nominal pressure 100					
	bolts						bolts					
	D	d <sub>1</sub>	K	number	thread	L	D	d <sub>1</sub>	K	number	thread	L
700	1045	840	935	24	M 52	56	no flanges					
800	1165	960	1050	24	M 56	62						
900	1285	1070	1170	28	M 56	62						
1000	1415	1180	1290	28	M 64	70						
1200	1665	1380	1530	32	M 72	78						

# FLANGES AS PER US STANDARDS

ASME B B16.5-2020 / B16.47-2020 (series A)

Class 150



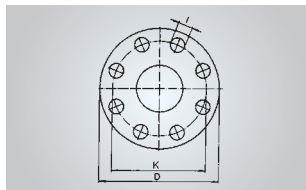
D Outside diameter  
K Bolt circle diameter  
I Bolt hole diameter

Nominal diameter		Flange				Bolts				
		outside diameter		bolt circle diameter		number	hole diameter		thread	
DN		D		K		–	L		–	
–	Inch	mm	Inch	mm	Inch	–	mm	Inch	mm	Inch
15	1/2	89	3.50	60.5	2.38	4	15.9	5/8	12.7	1/2
20	3/4	99	3.88	69.8	2.75	4	15.9	5/8	12.7	1/2
25	1	108	4.25	79.2	3.12	4	15.9	5/8	12.7	1/2
32	1 1/4	117	4.62	88.9	3.50	4	15.9	5/8	12.7	1/2
40	1 1/2	127	5.00	98.6	3.88	4	15.9	5/8	12.7	1/2
50	2	152	6.00	120.6	4.75	4	19.0	3/4	15.9	5/8
65	2 1/2	178	7.00	139.7	5.50	4	19.0	3/4	15.9	5/8
80	3	190	7.50	152.4	6.00	4	19.0	3/4	15.9	5/8
100	4	229	9.00	190.5	7.50	8	19.0	3/4	15.9	5/8
125	5	254	10.00	215.9	8.50	8	22.2	7/8	19.0	3/4
150	6	279	11.00	241.3	9.50	8	22.2	7/8	19.0	3/4
200	8	343	13.50	298.4	11.75	8	22.2	7/8	19.0	3/4
250	10	406	16.00	362.0	14.25	12	25.4	1	22.2	7/8
300	12	483	19.00	431.8	17.00	12	25.4	1	22.2	7/8
350	14	533	21.00	476.2	18.75	12	28.6	1 1/8	22.2	1
400	16	597	23.50	539.8	21.25	16	28.6	1 1/8	25.4	1
450	18	635	25.00	577.8	22.75	16	31.7	1 1/4	28.6	1 1/8
500	20	693	27.50	635.0	25.00	20	31.7	1 1/4	28.6	1 1/8
600	24	813	32.00	749.3	29.50	20	34.9	1 3/8	31.7	1 1/4
700	28	927	36.50	863.6	34.00	28	34.9	1 3/8	31.7	1 1/4
800	32	1060	41.75	977.9	38.50	28	34.9	1 3/8	31.7	1 1/4
900	36	1168	46.00	1085.8	42.75	32	41.3	1 5/8	38.1	1 1/2
1000	40	1289	50.75	1200.2	47.25	36	41.3	1 5/8	38.1	1 1/2

# FLANGES AS PER US STANDARDS

ASME B16.5-2020 / B16.47-2020 (Serie A)

Class 300



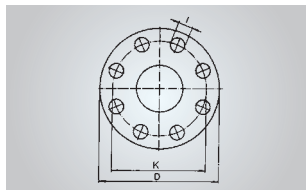
D Outside diameter  
K Bolt circle diameter  
I Bolt hole diameter

Nominal diameter		Flange				Bolts				
		outside diameter		bolt circle diameter		number	hole diameter		thread	
DN		D		K		–	L		–	
–	Inch	mm	Inch	mm	Inch	–	mm	Inch	mm	Inch
15	1/2	95	3.75	66.7	2.62	4	15.9	5/8	12.7	1/2
20	3/4	115	4.62	82.6	3.25	4	19.0	3/4	15.9	5/8
25	1	125	4.88	88.9	3.50	4	19.0	3/4	15.9	5/8
32	1 1/4	135	5.25	98.4	3.88	4	19.0	3/4	15.9	5/8
40	1 1/2	155	6.12	114.3	4.50	4	22.2	7/8	19.0	3/4
50	2	165	6.50	127.0	5.00	8	19.0	3/4	15.9	5/8
65	2 1/2	190	7.50	149.2	5.88	8	22.2	7/8	19.0	3/4
80	3	210	8.25	168.3	6.62	8	22.2	7/8	19.0	3/4
100	4	255	10.00	200.0	7.88	8	22.2	7/8	19.0	3/4
125	5	280	11.00	235.0	9.25	8	22.2	7/8	19.0	3/4
150	6	320	12.50	269.9	10.62	12	22.2	7/8	19.0	3/4
200	8	380	15.00	330.2	13.00	12	25.4	1	22.2	7/8
250	10	445	17.50	387.3	15.25	16	28.6	1 1/8	25.4	1
300	12	520	20.50	450.8	17.75	16	31.7	1 1/4	28.6	1 1/8
350	14	585	23.00	514.4	20.25	20	31.7	1 1/4	28.6	1 1/8
400	16	650	25.50	571.5	22.50	20	34.9	1 3/8	31.7	1 1/4
450	18	710	28.00	628.6	24.75	24	34.9	1 3/8	31.7	1 1/4
500	20	775	30.50	685.8	27.00	24	34.9	1 3/8	31.7	1 1/4
600	24	915	36.00	812.8	32.00	24	41.3	1 5/8	38.1	1 1/2
700	28	1035	40.75	939.8	37.00	28	44.4	1 3/4	41.3	1 5/8
800	32	1150	45.25	1054.1	41.50	28	47.6	1 7/8	44.4	1 3/4
900	36	1270	50.00	1168.4	46.00	32	54.0	2 1/8	50.8	2
1000	40	1240	48.75	1155.7	45.50	36	54.0	2 1/8	50.8	2



# FLANGES AS PER US STANDARDS

ASME B 16.5-2020 / B16.47-2020 (series A)  
Class 400



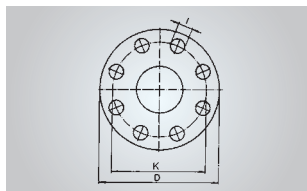
D Outside diameter  
K Bolt circle diameter  
I Bolt hole diameter

Nominal diameter		Flange				Bolts				
		outside diameter		bolt circle diameter		number	hole diameter		thread	
DN		D		K		–	L		–	
–	Inch	mm	Inch	mm	Inch	–	mm	Inch	mm	Inch
15	1/2									
20	3/4									
25	1									
32	1 1/4									
40	1 1/2									
50	2									
65	2 1/2									
80	3									
Connection dimensions. see Class 600										
100	4	254	10.00	200.2	7.88	8	25.4	1	22.2	7/8
125	5	279	11.00	235.0	9.25	8	25.4	1	22.2	7/8
150	6	318	12.50	269.7	10.62	12	25.4	1	22.2	7/8
200	8	381	15.00	330.2	13.00	12	28.6	1 1/8	25.4	1
250	10	444	17.50	387.4	15.25	16	31.7	1 1/4	28.6	1 1/8
300	12	521	20.50	450.8	17.75	16	34.9	1 3/8	31.7	1 1/4
350	14	584	23.00	514.4	20.25	20	34.9	1 3/8	31.7	1 1/4
400	16	648	25.50	571.5	22.50	20	38.1	1 1/2	34.9	1 3/8
450	18	711	28.00	628.6	24.75	24	38.1	1 1/2	34.9	1 3/8
500	20	775	30.50	685.8	27.00	24	41.3	1 5/8	38.1	1 1/2
600	24	914	36.00	812.8	32.00	24	47.6	1 7/8	44.4	1 3/4
700	28	1035	40.75	939.8	37.00	28	47.6	1 7/8	44.4	1 3/4
800	32	1149	45.25	1054.1	43.50	28	54.0	2 1/8	50.8	2
900	36	1270	50.00	1168.4	46.00	32	54.0	2 1/8	50.8	2
1000	40	1270	50.00	1174.8	46.25	36	66.7	2 5/8	63.5	2 1/2

# FLANGES AS PER US STANDARDS

ASME B16.5-2020 / B16.47-2020 (Serie A)

Class 600



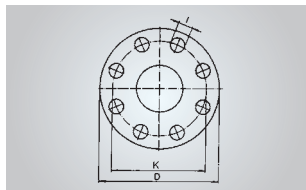
D Outside diameter  
K Bolt circle diameter  
I Bolt hole diameter

Nominal diameter		Flange				Bolts				
		outside diameter		bolt circle diameter		number	hole diameter		thread	
DN		D		K		–	L		–	
–	Inch	mm	Inch	mm	Inch	–	mm	Inch	mm	Inch
15	1/2	95	3.75	66.5	2.62	4	15.9	5/8	12.7	1/2
20	3/4	117	4.62	82.6	3.25	4	19.0	3/4	15.9	5/8
25	1	124	4.88	88.9	3.50	4	19.0	3/4	15.9	5/8
32	1 1/4	133	5.25	98.6	3.88	4	19.0	3/4	15.9	5/8
40	1 1/2	155	6.12	114.3	4.50	4	22.2	7/8	19.0	3/4
50	2	165	6.50	127.0	5.00	8	19.0	3/4	15.9	5/8
65	2 1/2	190	7.50	149.4	5.88	8	22.2	7/8	19.0	3/4
80	3	210	8.25	168.1	6.62	8	22.2	7/8	19.0	3/4
100	4	273	10.75	215.9	8.50	8	25.4	1	22.2	7/8
125	5	330	13.00	266.7	10.50	8	28.6	1 1/8	25.4	1
150	6	356	14.00	292.1	11.50	12	28.6	1 1/8	25.4	1
200	8	419	16.50	349.2	13.75	12	31.7	1 1/4	28.6	1 1/8
250	10	508	20.00	431.8	17.00	16	34.9	1 3/8	31.7	1 1/4
300	12	559	22.00	489.0	19.25	20	34.9	1 3/8	31.7	1 1/4
350	14	603	23.75	527.0	20.75	20	38.1	1 1/2	34.9	1 3/8
400	16	686	27.00	603.2	23.75	20	41.3	1 5/8	38.1	1 1/2
450	18	743	29.25	654.0	25.75	20	44.4	1 3/4	41.3	1 5/8
500	20	813	32.00	723.9	28.50	24	44.4	1 3/4	41.3	1 5/8
600	24	940	37.00	838.2	33.00	24	50.8	2	47.6	1 7/8
700	28	1073	42.25	965.2	38.00	28	50.8	2	47.6	1 7/8
800	32	1194	47.00	1079.5	42.50	28	54.0	2 1/8	50.8	2
900	36	1314	51.75	1193.8	47.00	28	66.7	2 5/8	63.5	2 1/2
1000	40	1321	52.00	1212.8	47.75	28	73.0	2 7/8	69.8	2 3/4

# FLANGES AS PER US STANDARDS

ASME B16.5-2020 / B16.47-2020 (Serie A)

Class 900

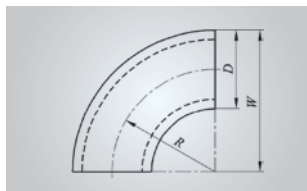


D Outside diameter  
K Bolt circle diameter  
I Bolt hole diameter

Nominal diameter		Flange				Bolts				
		outside diameter		bolt circle diameter		number	hole diameter		thread	
DN		D		K		–	L		–	
–	Inch	mm	Inch	mm	Inch	–	mm	Inch	mm	Inch
15	1/2	121	4.75	82.6	3.25	4	22.2	7/8	19.0	3/4
20	3/4	130	5.12	88.9	3.50	4	22.2	7/8	19.0	3/4
25	1	149	5.88	101.6	4.00	4	25.4	1	22.2	7/8
32	1 1/4	159	6.25	111.1	4.38	4	25.4	1	22.2	7/8
40	1 1/2	178	7.00	124.0	4.88	4	28.6	1 1/8	25.4	1
50	2	216	8.50	165.1	6.50	8	25.4	1	22.2	7/8
65	2 1/2	244	9.62	190.5	7.50	8	28.6	1 1/8	25.4	1
80	3	241	9.50	190.5	7.50	8	25.4	1	22.2	7/8
100	4	292	11.50	235.0	9.25	8	31.7	1 1/4	28.6	1 1/8
125	5	349	13.75	279.4	11.00	8	34.9	1 3/8	31.7	1 1/4
150	6	381	15.00	317.5	12.50	12	31.7	1 1/4	28.6	1 1/8
200	8	470	18.50	393.7	15.50	12	38.1	1 1/2	34.9	1 3/8
250	10	546	21.50	469.9	18.50	16	38.1	1 1/2	34.9	1 3/8
300	12	610	24.00	533.4	21.00	20	38.1	1 1/2	34.9	1 3/8
350	14	641	25.25	558.8	22.00	20	41.3	1 5/8	38.1	1 1/2
400	16	705	27.75	616.0	24.25	20	44.4	1 3/4	41.3	1 5/8
450	18	787	31.00	685.8	27.00	20	50.8	2	47.6	1 7/8
500	20	857	33.75	749.3	29.50	20	54.0	2 1/8	50.8	2
600	24	1041	41.00	901.7	35.50	20	66.7	2 5/8	63.5	2 1/2
700	28	1168	46.00	1022.4	40.25	28	47.6	1 7/8	44.4	1 3/4
800	32	1314	51.75	1155.7	45.50	28	54.0	2 1/8	50.8	2
900	36	1460	57.50	1289.0	50.75	32	54.0	2 1/8	50.8	2
1000	40	1511	59.50	1339.8	52.75	36	66.7	2 5/8	63.5	2 1/2

# PIPE BEND. 90°

DIN EN 10253-2. edition 09.2008

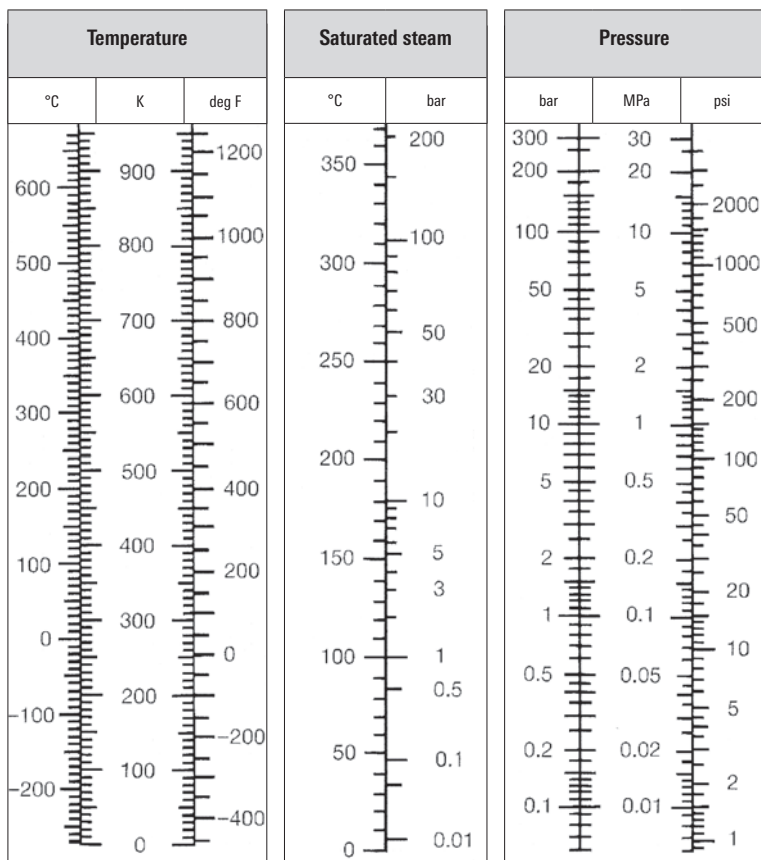


Nominal diameter	Outside diameter	Type 2: R ~ 1.0 x D		Type 3: R ~ 1.5 x D	
		R 1"	O	R 1"	O
DN	D	R 1"	O	R 1"	O
–	mm	mm	mm	mm	mm
50	60.3	51	81	76	106
65	76.1	63	102	95	133
80	88.9	76	121	114	159
100	114.3	102	159	152	210
125	139.7	127	197	190	260
150	168.3	152	237	229	313
200	219.1	203	313	305	414
250	273	254	391	381	518
300	323.9	305	467	457	619
350	355.6	356	533	533	711
400	406.4	406	610	610	813
450	457	457	686	686	914
500	508	508	762	762	1016
600	610	610	914	914	1219
700	711	711	1066	1067	1422
800	813	813	1220	1219	1626
900	914	914	1371	1372	1829
1000	1016	1016	1524	1524	2032

# CONVERSION TABLES AND FORMULA SYMBOLS



# TEMPERATURE, SATURATED STEAM, PRESSURE



# STEAM TABLE

Pressure (absolute)	Saturation temperature	Kinematic viscosity of steam	Density of steam
bar	°C	$10^{-6} \text{ m}^2/\text{s}$	$\text{kg}/\text{m}^3$
P	t	$\nu^a$	$\rho^a$
0.02	17.513	650.24	0.01492
0.04	28.983	345.295	0.02873
0.06	36.183	240.676	0.04212
0.08	41.534	186.72	0.05523
0.1	45.833	153.456	0.06814
0.14	52.574	114.244	0.09351
0.2	60.086	83.612	0.1307
0.25	64.992	68.802	0.1612
0.3	69.124	58.69	0.1912
0.4	75.886	45.699	0.2504
0.45	78.743	41.262	0.2796
0.5	81.345	37.665	0.3086
0.6	85.954	32.177	0.3661
0.7	89.959	28.178	0.4229
0.8	93.512	25.126	0.4792
0.9	96.713	22.716	0.535
1	99.632	20.76	0.5904
1.5	111.37	14.683	0.8628
2	120.23	11.483	1.129
2.5	127.43	9.494	1.392
3	133.54	8.13	1.651
3.5	138.87	7.132	1.908
4	143.62	6.367	2.163
4.5	147.92	5.76	2.417

Pressure (absolute)	Saturation temperature	Kinematic viscosity of steam	Density of steam
bar	°C	$10^{-6} \text{ m}^2/\text{s}$	$\text{kg}/\text{m}^3$
P	t	$\nu^{\circ}$	$\rho^{\circ}$
5	151.84	5.268	2.669
6	158.84	4.511	3.17
7	164.96	3.956	3.667
8	170.41	3.531	4.162
9	175.36	3.193	4.655
10	179.88	2.918	5.147
11	184.07	2.689	5.637
12	187.96	2.496	6.127
13	191.61	2.33	6.617
14	195.04	2.187	7.106
15	198.29	2.061	7.596
20	212.37	1.609	10.03
25	223.94	1.323	12.51
30	233.84	1.126	15.01
34	240.88	1.008	17.03
38	247.31	0.913	19.07
40	250.33	0.872	20.1
45	257.41	0.784	22.68
50	263.91	0.712	25.33
55	269.93	0.652	28.03
60	275.55	0.601	30.79
65	280.82	0.558	33.62
70	285.79	0.519	36.51
75	290.5	0.486	39.48



**PHYSICAL UNITS (D, GB, US)**

DIN 1301-1, edition 10.2010 among others

**SI-Basic Units**

Size	SI-Basic Unit	
	Name	Symbol
Length	metre	m
Mass	kilogram	kg
Time	second	s
Current intensity	Ampere	A
Thermodynamic temperature	Kelvin	K
Quantity of material	Mol	mol
Light intensity	Candela	cd

**Prefix symbols**

Prefix	Prefix symbol	Multiplication factor
Piko	p	$10^{-12}$
Nano	n	$10^{-9}$
Micro	$\mu$	$10^{-6}$
Milli	m	$10^{-3}$
Centi	c	$10^{-2}$
Deci	d	$10^{-1}$
Deca	da	$10^1$
Hecto	h	$10^2$
Kilo	k	$10^3$
Mega	M	$10^6$
Giga	G	$10^9$

**Length - SI-Unit metre, m**

Symbol	Name	in m
mm	millimetre	0.0010
km	kilometre	1000
in	Inch	0.0254
ft	foot (=12 in)	0.3048
yd	yard (=3ft / = 36 in)	0.9144

## Mass – SI-Unit kilogram, kg

Symbol	Name	in kg
g	gram	0.00100
t	ton	1000
oz	ounce	0.02835
lb	pound	0.45360
sh tn	short ton (US)	907.2
tn	ton (UK)	1016

## Time – SI-Unit second, s

Symbol	Name	in s
min	minute	60
h	hour	3600
d	day	86400
a	year	$3.154 \cdot 10^7$ ( $\Delta$ 8760 h)

## Temperature – SI-Unit Kelvin, K

Symbol	Name	in K	in °C
°C	degree centigrade	$\vartheta/^\circ\text{C} + 273.16$	1
deg F	degree Fahrenheit	$\vartheta/\text{deg F} \cdot 5/9 + 255.38$	$(\vartheta/\text{deg F} - 32) \cdot 5/9$

## Angle – SI-Unit Radian, rad = m/m

Symbol	Name	in rad
	full angle	$2\pi$
gon	gon (new deg.)	$\pi/200$
°	degree (deg.)	$\pi/180$
'	minute	$\pi/1.08 \cdot 10^4$
"	second	$\pi/6.48 \cdot 10^5$

**Pressure – SI-Unit Pascal, Pa = N/m<sup>2</sup> = kg/ms<sup>2</sup>**

Symbol	Name	in Pa	in bar
Pa = N/m <sup>2</sup>	Pascal	1	0.00001
hPa = mbar	Hectopascal = millibar	100	0.001
kPa	Kilopascal	1000	0.01
bar	Bar	100000	1
MPa = N/mm <sup>2</sup>	Megapascal	1000000	10
mm WS	millimetre water column	9.807	0.0001
lbf/in <sup>2</sup> = psi	pound-force per square inch	6895	0.0689
lbf/ft <sup>2</sup>	pound-force per square foot	47.88	0.00048

**Energy (also called Work, Quantity of Heat) SI-Unit Joule, J = Nm = Ws**

Symbol	Name	in J
kWs	kilowatt second	1000
kWh	kilowatt hours	3.6 · 10 <sup>6</sup>
kcal	kilocalorie	4186
lbf x ft	pound-force foot	1.356
Btu	British thermal unit	1055

**Capacity – SI-Unit Watt, W = m<sup>2</sup> kg/s<sup>3</sup> = J/s**

Symbol	Name	in W
kW	kilowatt	1000
PS	horsepower	735.5
hp	horsepower	745.7

**Volume – SI-Unit, m<sup>3</sup>**

Symbol	Name	in m <sup>3</sup>
l	litre	0.001
in <sup>3</sup>	cubic inch	1.6387 · 10 <sup>-5</sup>
ft <sup>3</sup>	cubic foot	0.02832
gal	gallon (UK)	0.004546
gal	gallon (US)	0.003785

# GREEK ALPHABET

α	Alpha	Α	Alpha
β	Beta	Β	Beta
γ	Gamma	Γ	Gamma
δ	Delta	Δ	Delta
ε	Epsilon	Ε	Epsilon
ζ	Zeta	Ζ	Zeta
η	Eta	Η	Eta
θ θ	Theta	Θ	Theta
ι	Jota	Ι	Jota
κ	Kappa	Κ	Kappa
λ	Lambda	Λ	Lambda
μ	My	Μ	My
ν	Ny	Ν	Ny
ξ	Xi	Ξ	Xi
ο	Omikron	Ο	Omikron
π	Pi	Π	Pi
ρ	Rho	Ρ	Rho
σ ς	Sigma	Σ	Sigma
τ	Tau	Τ	Tau
υ	Ypsilon	Υ	Ypsilon
φ	Phi	Φ	Phi
χ	Chi	Χ	Chi
ψ	Psi	Ψ	Psi
ω	Omega	Ω	Omega