



Quality by Witzemann



Witzemann GmbH

Östliche Karl-Friedrich-Str. 134
75175 Pforzheim, Germany
Phone +49 7231 581-0
Fax +49 7231 581-820
wi@witzemann.com
www.witzemann.de

1301.uk/8/05/20/pdf

WITZENMANN

managing flexibility

METAL HOSES

WITZENMANN

METAL HOSE MANUAL



Fully revised version of metal hoses handbook.

As at: November 2015

Technical changes reserved.

**Technical details are available as a PDF download on the Internet at
www.flexperte.de**

Our calculation and design software FLEXPORTE contains all of the technical principles required for the configuration of expansion joints, metal hoses, metal bellows and hangers and supports.

CONTENTS

1 Witzenmann – the specialist for flexible metal elements 6

2 Products and production methods 10

2.1	HYDRA hose assemblies	12
2.2	HYDRA corrugated hoses	13
2.3	HYDRA hose braidings	17
2.4	Materials for metal hose assemblies	19
2.5	Connection fittings and interfaces	19
2.6	HYDRA stripwound hoses	23
2.7	Standards and guidelines	27
2.8	Quality management	32
2.9	Certification and customised approvals	36

3 Typical metal hose applications 38

3.1	Industry	40
	- Flexible heat tracing system	40
	- Insulating hose assemblies	41
	- Double hose assemblies	42
	- Hose assemblies for chemical substances	43
	- Hose assemblies for foodstuffs	45
	- PTFE-lined metal hoses	45
	- Hose assemblies for presses	46
	- High-pressure hoses for technical gases	47
	- Lance hoses for steel plants	49
	- Vibration absorbers	50
3.2	Vacuum technology / medical technology / optoelectronics	52
	- Vacuum hoses	52
	- Miniature hoses	52

3.3	Green energy	53
	- Solar hoses	53
	- Combined heat and power units	54
	- Flexible joints for solar panels	54
3.4	Heating and ventilation	56
	- Hoses for kitchens and bathrooms	56
	- Drinking water feeder hoses	57
	- Gas hoses according to DIN 3384	58
	- HYDRA GS – gas hoses for buildings as per EN 15266	58
	- Gas hoses for household devices as per EN 14800	59
	- Equipment piping	61
	- Cooling ceiling hoses	62
	- Sprinkler mounting systems	63
	- Heat exchangers	64

4 Design, calculation and installation for corrugated hoses 66

4.1	Pressure resistance and service life	68
4.2	Pressure loss and flow-induced vibrations	76
4.3	Absorption of movements	87
4.4	Absorption of thermal expansions	91
4.5	Compensation of mounting tolerances and pipework offset	97
4.6	Absorption of vibrations	98
4.7	Installation and assembly instructions	100

5 Product testing at Witzenmann 108

5.1	Testing and analysis options	110
5.2	Production-related tests on metal hoses	112
5.3	Type approval and destructive tests on metal hoses	114

CONTENTS

6	Technical tables	116
6.1	Hose selection from the manual	118
6.2	Hose selection with FLEXPORTE	123
6.3	HYDRA annularly corrugated hoses – goods sold by the metre	124
	- RS 330 / 331 – stainless steel annularly corrugated hoses	124
	- RS 321 – stainless steel annularly corrugated hoses	126
	- RS 341 – stainless steel annularly corrugated hoses	128
	- RS 531 – stainless steel annularly corrugated hoses	130
	- RS 430 – stainless steel annularly corrugated hoses	132
	- RZ 331 – bronze annularly corrugated hoses	134
	- RS 351 – semi-flexible annularly corrugated hoses	136
	- IX 331 – semi-flexible annularly corrugated hoses	137
	- ME 539 – semi-flexible helical corrugated hoses	138
6.4	Connection fittings	139
	- Connection fittings for HYDRA corrugated hose assemblies	140
	- Self-assembly connection fittings	174
6.5	HYDRA annularly corrugated hose assemblies	184
	- HYDRA double hose assemblies	184
	- HYDRA insulating hose	186
	- PTFE-lined HYDRA hose assemblies	187
	- HYDRA vibration absorber	188
	- HYDRA gas hose assemblies according to DIN 3384	190
	- Hose assemblies for presses	194
	- Hydraflex – hose assemblies for semi-flexible pipework	198
6.6	HYDRA stripwound hoses – fittings, hose assemblies	200
	- HYDRA protective hoses	202
	- Connection fittings for HYDRA – stripwound hoses	228
	- Air extraction, exhaust and conveying hoses	231
	- Flexible arms	250

7	Data sheets	260
7.1	Pipes, flanges, pipe bends, threads	262
7.2	Material data sheets	288
7.3	Nominal pressure levels for malleable iron	312
7.4	Corrosion resistance	313
7.5	Conversion tables, formula symbols, steam table	352
7.6	Glossary	362
7.7	Inquiry specification	370

WITZENMANN, THE SPECIALIST FOR FLEXIBLE METAL ELEMENTS

1 Witzemann – the specialist for flexible metal elements

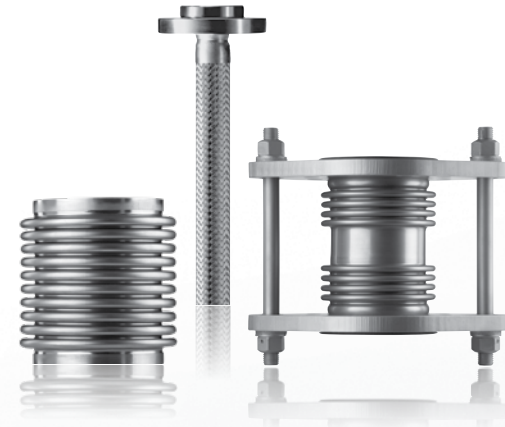

Solution competence

Flexible metal elements are used whenever flexible components must be sealed in a pressure-, temperature and media-resistant manner, when deformations of pipe systems caused by changes in temperature or pressure must be compensated, when vibrations occur in piping systems, when media must be transported under pressure or when a high vacuum must be sealed. They include e.g. metal bellows, diaphragm bellows, metal hoses or expansion joints.

Witzemann, the inventor of the metal hose and founder of the metal hose and expansion joint industry is the top name in this area. The first invention, a metal hose which was developed and patented in 1885, was followed by a patent for the metal expansion joint in 1920.

OUR FLEXIBLE NETWORK IN THE GROUP



America

Brazil
Mexico
USA

Europe

Austria
Belgium
Czech Republic
France
Germany
Great Britain
Italy
Poland
Russia
Slovakia
Spain
Sweden

Asia

China
India
Japan
Korea

1. Our Flexible Network in the Group

Global presence

As an international group of companies with over 4,000 employees and over 24 subsidiaries, Witzenmann today stands for innovation and high quality. In its role as technological leader, Witzenmann provides comprehensive development know-how and the broadest product range in the branch. It develops solutions for flexible seals, vibration decoupling, pressure dampening, compensation of thermal expansion, flexible mounting or transport of media. As a development partner to customers in industry, the automotive sector, the building equipment sector, the aviation and aerospace industry and many other markets, Witzenmann manufactures its own machines, tools and prototypes, and also has comprehensive testing and inspection systems.

An important factor in its cooperation with customers is the technical advice provided by the Witzenmann competence centre, located at the Pforzheim headquarters in Germany. Here, teams of highly-qualified engineers work together with the customer to develop products and new applications. Our experts support customers from the first planning stage up to series production.

Better products

This type of broad-based knowledge results in synergy effects, which can be experienced in each product solution. The variety of application areas is nearly limitless. However, all the product solutions have the same thing in common: maximum safety, even under sometimes extreme operating conditions. This applies to all Witzenmann solutions – ranging from highly-flexible hose assemblies or expansion joints for use in industry to precision bellows for high-pressure fuel pumps, piezo injectors or pressure sensor spark plugs in modern car engines.

PRODUCTS AND PRODUCTION METHODS



2. Products and production methods

2.1	HYDRA hose assemblies	12
2.2	HYDRA corrugated hoses	13
2.3	HYDRA hose braidings	17
2.4	Materials for metal hose assemblies	19
2.5	Connection fittings and interfaces	19
2.6	HYDRA stripwound hoses	23
2.7	Standards and guidelines	27
2.8	Quality management	32
2.9	Certification and customised approvals	36

2.1 HYDRA® hose assemblies

A hose assembly consists of a corrugated hose as leakproof and pressure-bearing element, hose braiding to absorb longitudinal force due to inner pressure as well as radial support for the hose and connection fittings as an interface to the surroundings. In addition, it is possible to mount a PTFE liner for increasing the chemical stability or for reducing the loss of pressure as well as an outer round wire coil or a protective hose to protect the metal hose mechanically.

The range of nominal diameters for HYDRA corrugated hoses in the standard program lies between 4 mm and 300 mm inside diameter. Larger diameters are available on request. The permissible operating pressures with small dimensions are sufficient with 4-fold cracking pressure safety up to 300 bar. The pressure resistance of larger dimensions is lower for technical reasons. The maximum temperature resistance for stainless steel hoses depending on compression load is approx. 550 °C; ,higher values are possible with other materials. Stainless steel corrugated hoses can be used at temperatures of up to -270 °C in the low temperature range.



Fig. 2.1.1 HYDRA hose assembly with PTFE interior liner.

2.2 HYDRA® corrugated hoses

Corrugated hoses are thin-walled, cylindrical components with a corrugated structure in their surface area. The type of corrugation differentiates annularly corrugated and coil corrugated hoses. The annular corrugation (fig. 2.2.1 left) has a large number of equally-spaced parallel corrugations, whose main plane is perpendicular to the hose axis. With the helical corrugation (fig.2.2.1 right) a mostly right-handed helix with constant pitch runs the whole length of the hose.

Annularly corrugated hoses are technically superior to helically corrugated hoses. Their profile direction perpendicular to the hose axis enables an undisturbed interface of the connection fittings and thereby increases the process stability during assembly and in service. In addition, annularly corrugated hoses do not produce torsion loads with increased pressure or pressure shocks. Thus, today annularly corrugated hoses are generally preferred.

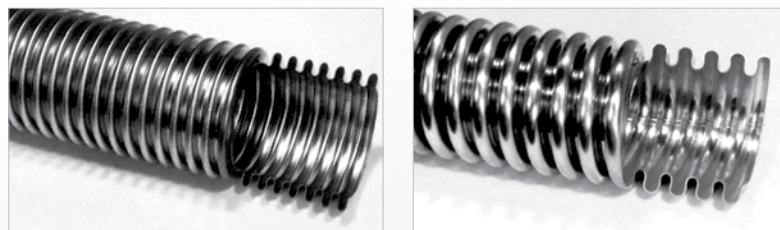

Fig. 2.2.1 Annularly corrugated hose (left) and helically corrugated hoses (right)

Through their corrugated structure, metal hoses are flexible and pressure resistant. They are leakproof, temperature and corrosion resistant as well as torsionally rigid and are used in the following applications:

- For transport of liquids and gases under pressure,
- As vacuum pipe,
- As economic, flexible connection for absorbing movements, heat expansion and/or vibrations plus
- As filling hose.

When configured correctly, HYDRA metal hoses are robust and nearly maintenance-free components with a high degree of operational safety and a long service life.

2.2 HYDRA® corrugated hoses

The elastic behaviour of the corrugated profile determines the flexibility of the corrugated hose. Fig. 2.2.2 shows that the corrugations are stretched on the outer curve, while they are compressed in the inner curve.

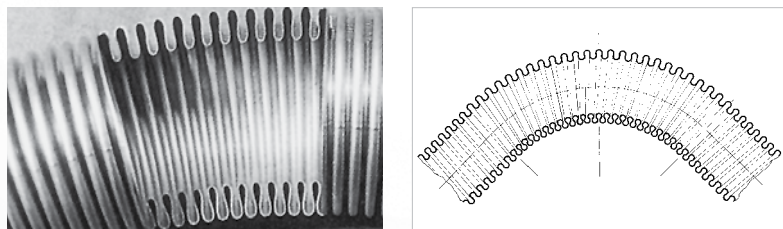

Fig. 2.2.2 Bending line of a corrugated hose in the cutaway model (left) and schematic (right)

Flexibility and pressure resistance of corrugated hoses are determined by the profile form: Flexibility increases with the increase of the profile height and with the reduction in the pitch, and at the same time the pressure resistance reduces. A reduction of the ply thickness increases flexibility and reduces the compressive strength. Table 2.2.1 sums up the influence of wall thickness and corrugation on flexibility and compressive strength.

Corrugation	Wall thickness	Pressure resistance	Flexibility
Narrow (cf. fig. 2.1.3) Hose type RS 321	Standard	+	++++
Standard Hose type RS 531, RS 430, RS 331	Standard	++	+++
	increases	+++	++
Wide (cf. fig. 2.1.4) Hose type RS 341	Standard	++	++

Table 2.2.1 relationship between corrugated geometry, pressure resistance and flexibility of a corrugated hose

2.2 HYDRA® corrugated hoses

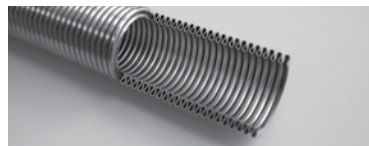

Fig. 2.2.3
Narrow corrugated, flexible hose profile



Fig. 2.2.4
Wide corrugated, pressure resistant hose profile



Fig. 2.2.5
Semi-flexible hose profile with low corrugation height

If, for example, in a pipework only a single bending of the hose is required, flat, semi-flexible profiles can be used. Fig. 2.2.5 shows an example of such a hose. Semi-flexible hoses are very cost-effective due to the minimal use of materials. Therefore, there has been a large number of customised profile forms in addition to the standard program.

HYDRA corrugated hoses are produced mechanically or hydraulically. Mechanical hose production is performed continuously in an endless procedure. Here, a cold-rolled metal strip with a ply thickness between 0,1 and 0,4 mm is formed and welded into an endless stainless steel tube. The hose profile is then formed by rotating corrugated tools from the outside into the tube. Depending on the profile type, one or more forming stages are required. Fig. 2.2.6 shows an example of corrugated tools in action. The profile form of the hose is defined by the contour and sequence of the corrugating tools used.

After forming the corrugations, the hoses are rolled onto drums and made available for further processing. With highly flexible hoses with undercut profile (fig. 2.2.3) there is an additional production stage when the hose is compressed. Mechanically produced metal hoses are generally single-ply hoses. In principle, multi-ply hoses can be produced using this method.

2.2 HYDRA® corrugated hoses

However, tube segments have then to be inserted into each other before the corrugations are formed, which leads to an intermittent and thereby less efficient process. The same applies to the use of seamless tubes as raw materials.

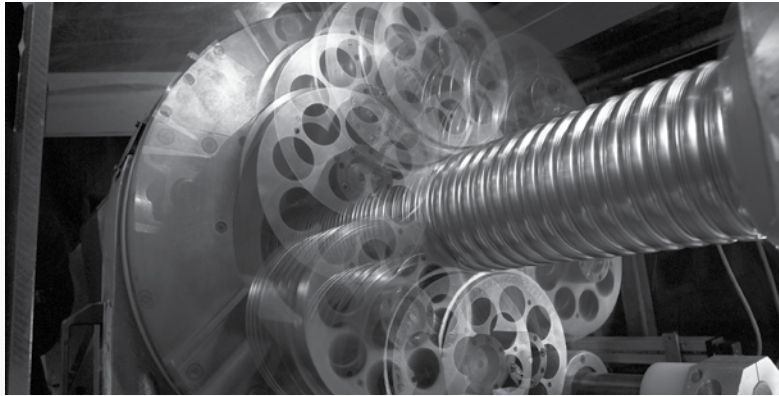

Fig 2.2.6 Corrugation tools in action

Hoses with large nominal diameters and/or heavy versions are produced hydraulically. Here, pipes are cut to length after welding is completed. During the forming of the corrugations, a cylindrical section of the tube is separated using outside and inside tools. Subsequently inside pressure is applied hydraulically. The pressure first shapes the sealed pipe section into the pre-corrugation. In the next step the tool is axially closed and the actual corrugation is formed as the pre-corrugation straightens up.

The length of individual hydraulically formed hose sections is limited due to the process. Bigger hose lengths can be manufactured via radial welding of the produced hose sections.

2.3 HYDRA® hose braidings

HYDRA hose braidings limit the expansion of a corrugated hose under internal pressure in axial direction. This increases the resistance to internal pressure of hoses by more than one order of magnitude. In addition, braided corrugated hoses can transmit tractive forces in an axial direction. HYDRA hose braidings flexibly suits the movement status of the hose even if a second braid is chosen to increase pressure resistance.

Fig. 2.3.1 schematically shows the functioning of the wire netting. It rests on the principle of lazy tongs. The expanded position is set by axial tension with the wires with the smallest crossing angles lie closely to each other and a hose braiding of the smallest possible diameter and the largest possible length. The crossing angle and diameter increase to the largest value through axial pushing together up to the compensation limit with the wires are also close together and the shortest length is achieved.

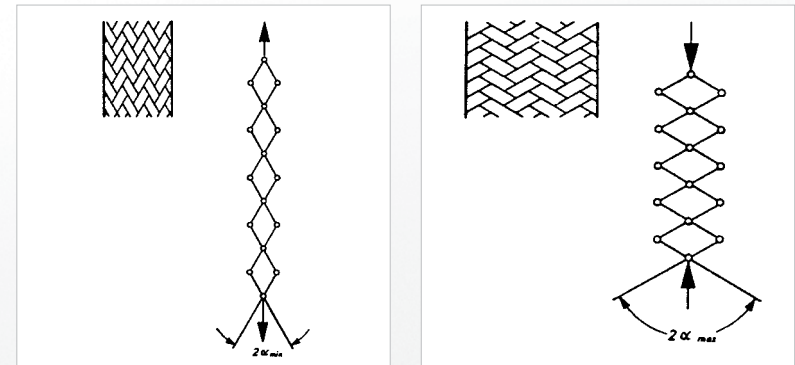

Fig. 2.3.1 Mode of action of hose braiding (schematic)

Fig. 2.3.2 shows the production of HYDRA hose braidings on a fully automatic braiding machine. Here, metal wire coils (strands according to ISO 10380) are braided from bobbins moving in opposite directions either directly on the metal hose or on a core. During the rotation, each clapper moves past alternatively in front of and behind the one it encounters.

2.3 HYDRA® hose braidings

Hollow braidings are taken off from the core after production, separated into sections and processed further.

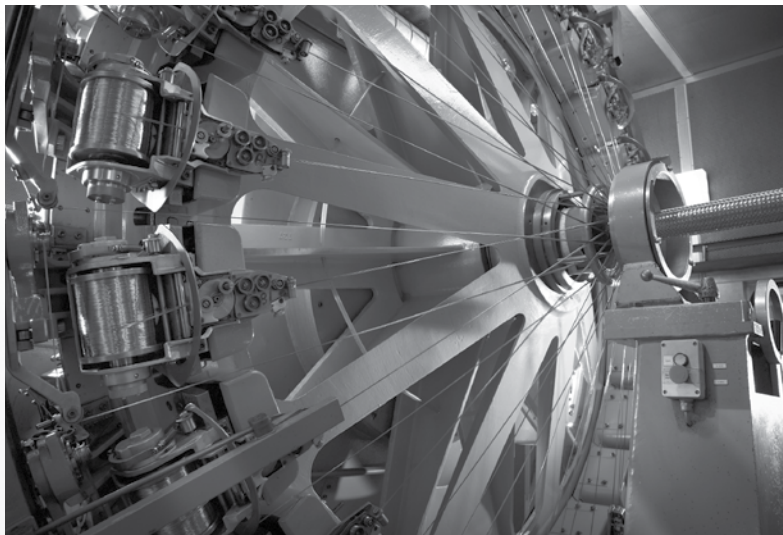

Fig. 2.3.2 Braiding production

With standard braiding, the wires on a wire clapper are parallel to each other, with knurled braiding the individual wires of a clapper are additionally braided with each other. This makes it possible to increase the wire cross section per clapper and the load capacity. Standard braids are used up to the hose nominal diameter DN 150; with larger nominal diameters knurled braidings are generally used.

The standard material for HYDRA hose braidings is cold-rolled stainless steel. Alternatively, bronze wires or plastics, such as carbon or aramid fibres, can be processed into hose braiding.

2.4 Materials for metal hose assemblies

Materials used in hose manufacture must feature a high degree of formability. For this reason, metals with a face centred cubical structure are preferred. The most important materials used in hose production are austenitic stainless steels and bronze, nickel based alloys are used less often. Materials are selected on the basis of requirements relating to

- Media and corrosion resistance,
- Temperature resistance and
- Mechanical strength and fatigue resistance

The standard material for HYDRA metal hoses is austenitic stainless 1.4404. It features high corrosion resistance, good mechanical strength, high fatigue resistance, excellent workability. Alternatively, the Ti-stabilised stainless steels 1.4541 and 1.4571, as well as with higher corrosion requirements the materials 1.4435, 1.4547 or 1.4565 can be used. Bronze (2.1020) is preferred due to the higher inner damping in vibration technology.

The preferred braid material is austenitic stainless steel 1.4301 or 1.4306 based on corrosion resistance.

2.5 Connection fittings and interfaces

A large number of different connections enable a wide range of applications for HYDRA metal hoses. Fig. 2.5.1 shows typical examples

Practically every connection produced from a welded or brazed material can be combined with a metal hose so that customised solutions are possible in addition to hose assemblies. An overview of common standard connections, possible materials, permissible pressure stages as well as the appropriate dimensions can be found in the technical tables in chapter 6.3.

2.5 Connection fittings and interfaces



Fig. 2.5.1 Hose assemblies with different connection fittings

With factory pre-assembled hose assemblies the labelling of the type of connection is the first letters of the type designation of the hose assembly:

Flanged joints:

- A: Loose flange with welding collar
- B: Loose flange with collar connection piece
- C: Loose flange with welding rim swivel flange
- G: Welding neck flange

Threaded connections:

- L: Internal thread, fixed
- M: External thread, fixed
- N: Internal thread, swivel

Screw connections:

- Q: Internal thread
- R: External thread
- S: Pipe end

Pipe connection:

- U: All types of pipe fittings

Couplings:

- W: All types of coupling

2.5 Connection fittings and interfaces

In addition to the use of factory-made hose assemblies, it is also possible to assemble hoses sold by the metre on site. The goods sold by the metre are cut to length and fitted with the appropriate connectors. Fig. 2.5.2 shows an un-braided annularly corrugated hose with fittings for self-assembly. The dimensions of the connectors and concrete assembly instructions are listed in chapter 6.3.

The non-braided hose RS 341 S00 with wide corrugation can be used as self-assembly annularly corrugated hoses, e.g for device piping or for connecting heaters. The braided corrugated hose RS 331 S12 with high corrugations is applicable for pressurised piping up to 16 bar operating pressure. Metal hoses with connection fittings for self-assembly cannot be used for dynamic loads, frequent movement, dangerous media or thermal oils.

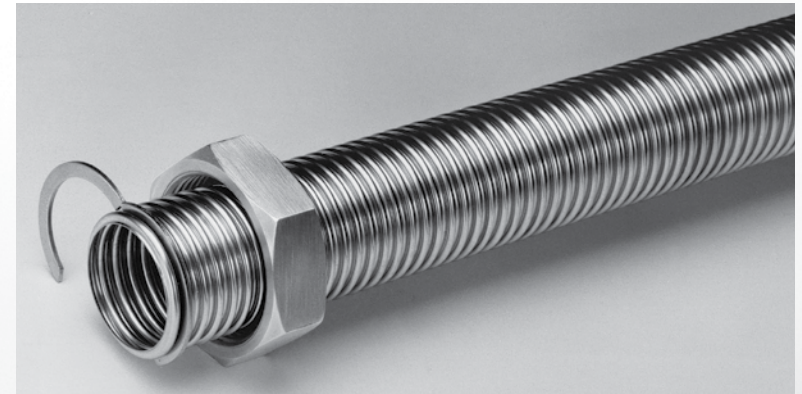

Fig. 2.5.2 Annularly corrugated hose for self-assembly

The connection of hose, braiding and connectors has a significant influence on the pressure resistance and service life of the metal hose assembly and must therefore be carried out very carefully. The method of attachment is centred on the version of connection fittings and the demands on the hose.

2.5 Connection fittings and interfaces

The most common connection method is fusion welding. Fig. 2.5.2 shows the corresponding connection of a HYDRA metal hose. When joining metal hose, braiding and connector together by fusion welding, it is important to completely cover all the components and, at the same time, keep the thermal load on the braiding wires to a minimum. Too large a thermal load of the braiding reduces the strength of the braiding wires and thereby reduces the pressure resistance of the hose assembly.

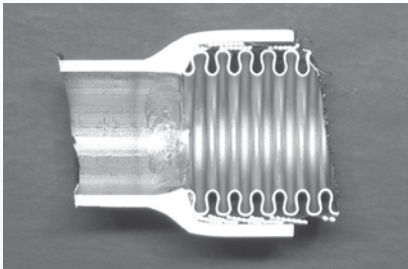

Fig. 2.5.2 Welded connection of HYDRA hose assemblies

Different types of connections, e.g. joining together connectors made of malleable iron can be completed by brazing. The same technological requirements apply here – the good integration of all components as well as minimum possible thermal load – as with fusion welding. Inductive brazing has proved to be a productive and reliable brazing process.

Processes are currently being developed for the reliable integration of non-metallic braiding, e.g. made of aramid or carbon fibres.

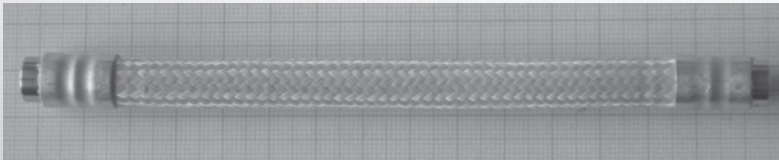

Fig. 2.5.3 Metal hose assembly with aramid coating

2.6 HYDRA® stripwound hoses

HYDRA stripwound hoses are created in a continuous process by profiling and helical coiling of a cold-rolled metal strip on a mandrel. Based on the low degree of deformation, stripwound hoses can also be made out of ferritic materials. Typical output materials are zinc-plated steel, stainless steel or brass, if necessary with a chromium-plated or nickel-plated surface.

When manufacturing stripwound hoses, the metal strip is first profiled in a multi-stage continuous process. Fig. 2.6.1 shows this in an exemplary way on the left side. In the next stage, the profiled strip is wound round a mandrel in a spiral form. The axial guiding of the strip and pressing onto the mandrel produces several revolving rollers as shown in fig. 2.6.1 on the left. In the second circulation round the mandrel, the fold on the profile is smoothed out so that the individual coils are linked to each other. The adjustable connection of the profile coils achieves the flexibility and mobility of the metal stripwound hose (fig. 2.6.2).

In order to avoid the stripwound hose unwinding, it is necessary to fix the hose ends after separating the endless hose.

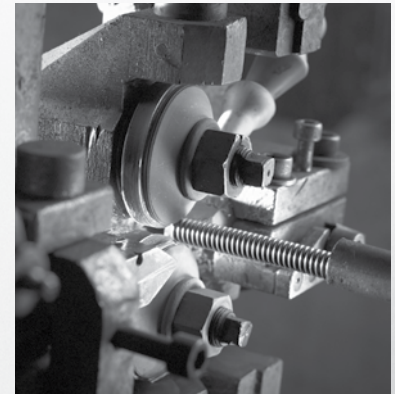

Fig. 2.6.1 Profiling and integration of the cold rolled strip (schematic, left) and production of stripwound hoses (right)

2.6 HYDRA® stripwound hoses

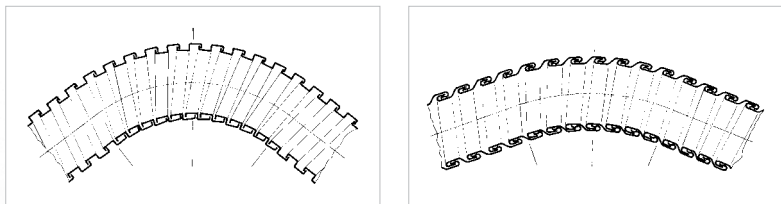

Fig 2.6.2 Movement of the stripwound hose by adjusting the coils relative to each other for an engaged profile (left) and an integrated profile (right)

Stripwound hoses are available in round and polygonal cross-section design forms; the profile forms stretch from the simple engaged profile up to the high tenacity integrated profile. Increased leak tightness can be achieved by introducing a sealing thread during the winding process into a specially profiled sealing chamber. Cotton, rubber and ceramic threads are used as sealing agents. To increase the leak tightness, for example against water splashes, PVC or silicone coatings can be used. Examples of stripwound hoses are shown in figures 2.6.3 to 2.6.6.

The production range of HYDRA stripwound hoses runs from miniature protective hose with 1 mm inside diameter up to the nominal diameter DN 500. The maximum manufactured lengths are dependent on the version and diameter, that can be over 100 m and more.



Fig. 2.6.3 rectangular stripwound hose with engaged profile



Fig. 2.6.4 stripwound hose with integrated profile

2.6 HYDRA® stripwound hoses



Fig. 2.6.5 stripwound hose with sealing thread

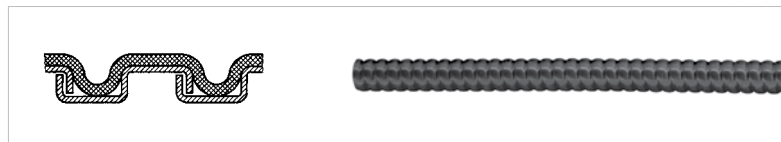

Fig. 2.6.6 stripwound hose with plastic coating

The advantages of stripwound hoses are a high resistance to tension and transversal pressure as well as chemical and thermal stability. They are, for example, used

- As protective hose for light conductors and electrical wiring,
- As over-bending protection for corrugated hose assemblies,
- As suction and conveying hose for smoke, shavings and granulates,
- As exhaust gas hose or
- As liner to optimise flow conditions

in mechanical engineering, measurement and control technology, communications technology and fibre optics as well as medical technology. Stripwound hoses are used in very large numbers as a liners in decoupling elements for car and HGV exhaust systems (fig. 2.6.7).

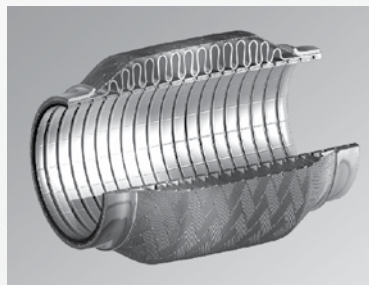

Fig. 2.6.7 Cross-sectional view through a decoupling element for car exhaust systems. It consists of an outer braiding, metal bellows and an integrated hose for flow control.

2.6 HYDRA® stripwound hoses

The group of wound metal hoses also includes flexible arms – also called swan necks –, that are created by winding a round wire coil together with a triangular wire (fig. 2.6.8). They can be bent in any direction and remain fixed in the corresponding position. Flexible arms are used for instance as adjustable brackets for lamps, magnifying glasses or microphones. Fitted with an inner plastic hose, flexible arms can also be used as refrigerant hoses in a machine tool. Their flexibility enables the pinpoint application of cooling lubricant.

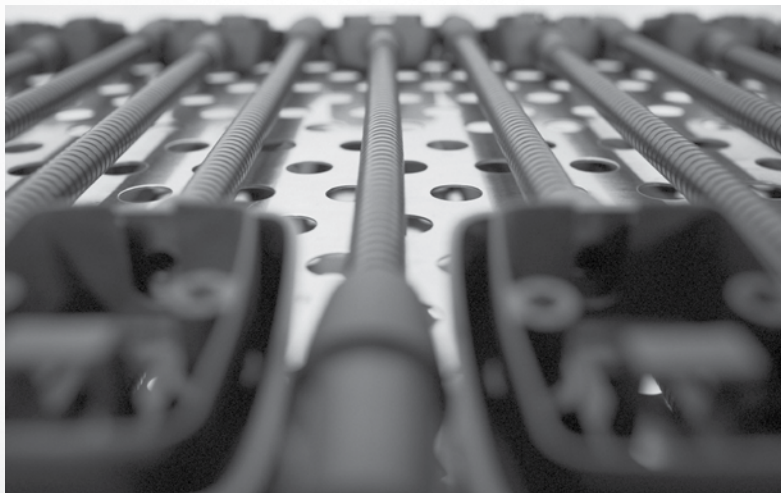

Fig. 2.6.8 Flexible arm

2.7 Standards and guidelines

Construction, design and use of metal hoses are influenced by different general and/or application-related standards. While the list is not exhaustive, table 2.7.1 summarizes important standards for metal hoses.

The most important general rules for metal hoses are the pressure equipment directive (97/23/EG, in short PED) with the accompanying product standard DIN EN 14585-1 "Pipework-Corrugated metal hose assemblies for pressure applications" and DIN EN ISO 10380 "Pipework-Corrugated metal hoses and metal hose assemblies". Explanations are provided below:

Pressure equipment directive and DIN EN 14585-1

The Pressure Equipment Directive applies for deliveries inside or to the European Economic Area (EEA). The guideline has legal validity and is binding on the user and manufacturer. It regulates the manufacture and marketing of pressure vessels with a maximum permissible operating pressure $PS > 0.5$ bar. According to the terminology of the guideline, metal hoses fall under the "pipeline" type of pressure devices.

The significant element of the pressure equipment directive is the classification of pressure equipment according to their potential risk in different categories. The potential risk of metal hoses is determined by the nominal diameter DN, the maximum permissible operating or design pressure PS, the danger of the medium, the aggregate status (liquid/gaseous) and the steam pressure of the medium.

All metal hose assemblies $DN \leq 25$ come under the area of "sound engineering practice" (SEP).

Categories I and II are typical for metal hose assemblies, category III less so. Hose assemblies in categories I – III are allocated a "CE" label. Depending on the category, the hose manufacturer has to carry out a conformity assessment. There are 9 different procedures with 11 modules available. The modules describe procedures that the manufacturer uses to ensure and explain that the relevant product meets the requirements of the guideline.

2.7 Standards and guidelines

Special metal hose applications for the aerospace, nuclear technology, vehicle technology, medical technology or the field heating and ventilation are regulated by other guidelines and are therefore excluded from the PED. The PED only describes the basic requirements for pressure equipment. The specification of regulations for certain components are subject to relevant product standards. For metal hoses that is DIN EN 14585-1. It describes the classification, materials, design, manufacture, approval and documentation for metal hose assemblies. In particular, with regard to type approval, DIN EN 14585-1 refers to DIN EN ISO 10380.

ISO 10380

DIN EN ISO 10380 "Pipework-Corrugated metal hoses and metal metal hose assemblies" is the most important international standard for metal hoses. It was last updated in 2013 and sets out the minimum requirements for the design, manufacture and inspection of corrugated metal hoses and metal hose assemblies. Within the meaning of the PED, DIN EN ISO 10380 has the character of a supportive standard.

According to DIN EN ISO 10380 metal hoses are characterised by their nominal width (DN), the operating pressure at the working temperature (PS), the nominal pressure (PN) and the service life in the U-bend test or cantilever test.

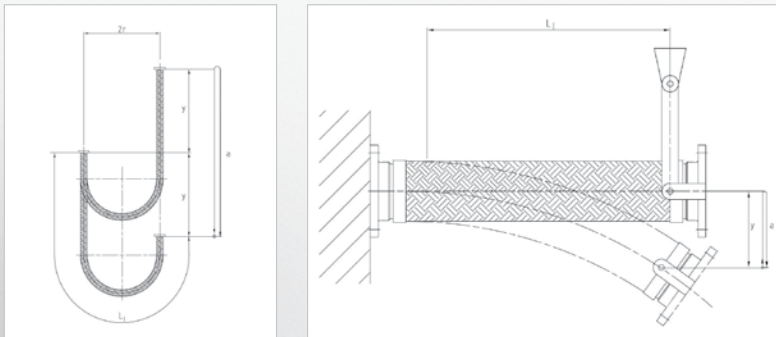

Fig. 2.7.1 U-bend- (left) and cantilever test (right), source DIN EN ISO 10380:2013

2.7 Standards and guidelines

The previous allocation to nominal pressure levels according to DIN EN ISO 10380:2003 will not apply in future. This means that intermediate values such as PN 90 are possible.

The test pressure is at least 1.43 times the nominal pressure. The remaining extension of the hose assembly test pressure must not exceed 1%. This criterion defines the nominal pressures for non-braided hose assemblies. The nominal pressure for braided hose assemblies is generally determined by the burst pressure of the hose assembly; it must be at least 4 times the nominal pressure.

Four quality levels differentiate the service life of the hoses

Type 1-50 – Corrugated metal hose with high flexibility and long service life ("high cycle life hose"):

- Bending radius type 1,
- Average service life 50,000 load cycles,
- Minimum service life 40,000 load cycles.

Type 1-10 – Corrugated metal hose with high flexibility and normal service life ("standard cycle life hose"):

- Bending radius type 1,
- Average service life 10,000 load cycles,
- Minimum service life 8,000 load cycles.

Type 2-10 – Corrugated metal hose with normal flexibility:

- Expanded bending radius type 2,
- Average service life 10,000 load cycles,
- Minimum service life 8,000 load cycles.

Type 3 – Corrugated metal hose, with pliability requirements

- No service life specification.

The type approval of the hose assemblies can be completed with or without monitoring via an external expert. In the first case, all hose assemblies can be identified as "certified products according to EN ISO 10380", in the second case merely as a "product according to EN ISO 10380".

2.7 Standards and guidelines

The conformity of the product characteristics with the details from the type approval must be verified for each type of hose at regular intervals by repeat tests. The repeat test intervals are 3 years for burst pressure, elongation and pliability and 5 years for service life.

Each manufacturer of metal hoses and metal hose assemblies according to EN ISO 10380 must implement a quality assurance system according to ISO 9001. Critical production parameters must be continually monitored. Suitably qualified personnel must be used and proof of the required qualification produced. All production, inspection and testing facilities must be in proper, calibrated condition according to ISO 9001.

Standard	Title	last update	Comment
1. general standards and standards for corrugated hoses			
ISO 10380	Pipework – corrugated metal hoses and metal hose assemblies	End of 2012	
ISO 10806	Pipework – fittings for corrugated metal hoses	March 2004	
ISO 7369	Pipework – metal hoses and hose assemblies – vocabulary	March 2005	
ISO 6708	Pipework components – definition and selection of DN (nominal size)	Sept. 1995	
EN 14585-1	Corrugated metallic hose assemblies for pressure applications	April 2004	Product standard for DGRL
DIN EN 13480-1	Metallic industrial piping; general information (Amendment1)	Aug. 2008	harmonised standard
DIN EN 13480-3	Metallic industrial piping; design and calculation (Amendment1)	Oct. 2010	harmonised standard
EN 13480-5	Metallic industrial pipes; inspection and testing	June 2006	harmonised standard
EN 1092-1	Flanges and their joints – circular flanges for pipes, fittings, valves and accessories – part 1: Steel flanges, PN designated	Sept. 2009	harmonised standard
2. Standards for stripwound hoses			
ISO 15465	Pipework – stripwound metal hoses and metal hose assemblies	July 2007	for stripwound hose types SG-, SA-
DIN EN 50086-2-4	Conduit systems for cable management - Parts 2-4; particular requirements for conduit systems buried underground	Dec. 2001	VDE approval for types SG-E-0 and SG-S-P

2.7 Standards and guidelines

3. Standards for industrial applications			
ISO 10807	Pipework – corrugated flexible metallic hose assemblies for the protection of electrical cables in explosive atmospheres	Jan. 1997	
ISO 21969	High-pressure flexible connections for use with medical gas systems	April 2004	
EN 12434	Cryogenic vessels – cryogenic flexible hoses	Nov. 2000	
EN 1736	Refrigerating systems and heat-pumps – flexible pipe elements, vibration isolators and expansion joints – requirements, design and installation	Feb. 2009	Vibration absorber type VX
EN 2827	Hose assemblies of stainless steels for chemical products	July 2006	
4. Standards for house and buildings technology			
DIN 3383-1	Hose assemblies and connection valves for gas safety hose assemblies, valves with quick connection device	June 1990	Not in area of applicability of DGRL, DIN EN 14800 and DIN EN 15069 supplement this standard
DIN 3384	Stainless steel flexible hose assemblies for gas applications-safety requirements, testing, marking	Aug. 2007	In area of applicability of DGRL, partially replaced by DIN EN 15069,
EN 14800	Corrugated safety metal hose assemblies for the connection domestic appliance using gaseous fuels	June 2007	Construction products regulation (CPR) not in application area of the DGRL
EN 15069	Safety gas connection valves for metal hose assemblies used for the connection of domestic appliances using for gaseous fuels	June 2008	Construction products regulation (CPR) not in application area of the DGRL
EN 15266	Stainless steel pliable corrugated tubing kits in buildings for gas with an operating pressure up to 0.5 bar	Aug. 2007	
DVGW GW 354	Corrugated pipework of stainless steel for gas and drinking water installations; requirements and tests	Sept. 2002	Partly deleted
TrinkwV 2011	Drinking water regulations	May 2011	
Factory Mutual FM1637	Flexible Sprinkler Hose with Threaded End Fittings	Feb. 2010	
Underwriters Laboratories UL 2443	Flexible Sprinkler Hose with Fittings for Fire Protection Service	May 2010	

Table 2.7.1 Standards overview

2.8 Quality management

Witzenmann's quality assurance system ensures that the products meet high quality requirements and thereby guarantees a high degree of service quality for the customers. Our quality assurance system is audited on a regular basis.

All subsidiaries in the Witzenmann-group fulfil regarding their QM systems, their welding approvals and supplier lists the necessary preconditions to supply hose assemblies according to PED.

Quality assurance is organised in two levels. Central quality assurance has responsibility over superordinate organisational and technical quality assurance measures. The quality depts of the individual business units assume quality planning, quality direction and quality inspection as part of order processing.

The quality assurance department is independent from production on an organisational level. It may issue instructions to all employees who carry out tasks which have an influence on quality.

Precise controls of suppliers

Witzenmann GmbH works exclusively with suppliers we have concluded quality assurance agreements with and which are certified at least according to ISO 9001. For semi-finished products such as bands, sheet metal, pipes and wires we require test certificates which are aligned according to the purpose of the component. Through supplier agreements and incoming inspections is ensured that the deliveries meet our ordering and acceptance test procedures. In this vein, we sometimes additionally restrict and define in more detail ranges for materials which are permissible according to DIN or other data sheets.

2.8 Quality management

Production monitoring and traceability

The responsibility for the control and maintenance of production facilities as well as the properly performed production according to the relevant manufacturer's documents is exercised by the company supervisors in production. We are fully able to trace our products via our PPS system and archived production paperwork.

Certified joining process

Witzenmann GmbH is a certified welding facility according to DIN EN ISO 3834-2, AD 2000 HP0, DIN EN 15085, NADCAP, DIN 2303 as well as KTA 1401. Welding procedure qualification records (WPQR) are carried out according to DIN EN ISO 15614-1 as well as according to AD 2000 reference sheet HP 2/1. The welding instructions are in accordance with the requirements of DIN EN ISO 15609-1. According to DIN EN ISO 3834-2, the certifications or requirements necessary for special applications must be specified by the customer. The qualification of welders is ensured and requalified according to DIN EN ISO 9606-1, DIN EN ISO 9606-4 as well as DIN ISO 24394 for fusion welders or according to DIN EN ISO 14732 for the welding personnel.

The welding supervision corresponds to the requirements of DIN EN ISO 14731 as well as AD 2000 reference sheet HP3.

The applied brazing processes conform to the requirements according to AD 2000 instructions HP 0, point 3.4, DIN EN 13134 and VDTÜV welding technology instructions 1160. Brazing tests are carried out according to DIN EN 13133.

2.8 Quality management

Monitoring of the measurement and test facilities

All measuring and test facilities are regularly checked for accuracy and reliability. Calibration dates are confirmed with monitoring indicators.

Approval tests

Prior to delivery, all products are subject to dimensional and visual testing, i.e. a visual inspection of hoses, weld seams and connecting parts as well as an inspection of installation length and connecting dimensions. A pressure and tightness test is carried out on hose assemblies prior to despatch. Depending on the height of the test pressure and the nominal diameter of the hose assembly, either a combined pressure/leak test with nitrogen under water or a hydraulic pressure test and then a leak test with nitrogen under water at reduced test pressure is carried out.

With hose assemblies that are not in the area of applicability of the PED, the test pressure is 1.3 times the nominal pressure (PN). If the PED are to be observed, the determination of the test pressure will confirm with the guidelines.

If the customer does not provide details on the medium and operating conditions, hose assemblies without braid will be subject to leak test at 0.5 bar and braided hose assemblies a pressure/leak test at 10 bar.

In addition, further inspections can be performed according to customer requirements; e.g load cycle tests according to standard or load cycle tests under near operating conditions. The type and scope of the tests is coordinated with the customer. The testing can be monitored by a Witzemann representative authorised to provide approvals, by an authorised representative of the customer, or an external certified agency.

2.8 Quality management

Test certificates

Test certificates for approval test as well as for the materials can be requested. Strip material, which is normally available in stock, can be confirmed with test certificate 3.1 or also 3.2 according to DIN EN 10204. Possible certificates related to the testing undertaken are listed in DIN EN 10204 (see Table 2.8.1.)

Designation	Test certificate	Type	Contents of certificate	Conditions	Confirmation of certificate
2.1	Certificate of conformity	non-specific	Confirmation of conformity with order.	As per the delivery conditions in the order or - if required - in accordance with official regulations and also applicable technical rules	from the manufacturer
2.2	Plant report		Confirmation of conformity with order with information on results of non-specific testing.		
3.1	Inspection certificate 3.1	specific	Confirmation of conformity with order with information of results of specific testing.	In accordance with official regulations and also applicable technical rules.	by manufacturer's representative in charge of approvals who is independent of the production department.
3.2	Inspection certificate 3.2		Confirmation of conformity with order with information of results of specific testing.		by manufacturer's representative in charge of approvals who is independent of the production department, and by representative in charge of approvals as authorised by the ordering party, or the representative in charge of approvals named in official regulations

Table 2.8.1 Test certificate as per DIN EN 10204

2.9 Certification and customised approvals

In 1994, Witzenmann was the first company in the industry to be certified according to DIN ISO 9001. Today, Witzenmann GmbH possesses the following general quality and environmental certifications:

ISO/TS 16949

ISO 9001

ISO 14001

EN 9100

Druckgeräterichtlinie

AD 2000 – Merkblatt W 0

AD 2000 – Merkblatt HP 0 / DIN EN ISO 3834-2 / HP 100 R

KTA 1401 und AVS D100/50

ASME U-Stamp

Product-specific approvals were issued by:

Gas/Water



DVGW Deutscher Verein des Gas- und Wasserfaches e.V., Germany
(Association of German Gas & Water Engineers)



ÖVGW Österreichische Vereinigung für das Gas- u. Wasserfach,
Austria (Austrian Association for Gas and Water)



SVGW Schweizerischer Verein des Gas- und Wasserfaches,
Switzerland (Swiss Association for Gas and Water)



IMQ
Insieme per la Qualità e la Sicurezza, Milan, Italy



DG
Danmarks Gasmateriel Prøvning, Denmark

2.9 Certification and customised approvals

Fire protection



VdS
Verband der Sachversicherer e.V., Germany



FM
Factory Mutual Research, USA

Shipping



ABS
American Bureau of Shipping, USA



BV
Bureau Veritas, France



DNV
Det Norske Veritas, Norway



LRS
Lloyd's Register of Shipping, Great Britain

Other



RTN – RosTechNadzor
Federal Supervisory Authority for Ecology, Technology and Nuclear
Technology, Russia



VDE
Prüf- und Zertifizierungsinstitut, Germany



AREVA NP GmbH
for the network of nuclear power plant operators, Germany

TYPICAL METAL HOSE APPLICATIONS



3. Typical metal hose applications

3.1	Industry	40
	- Flexible heat tracing system	40
	- Insulating hose assemblies	41
	- Double hose assemblies	42
	- Hose assemblies for chemicals substances	43
	- Hose assemblies for foodstuffs	45
	- PTFE-lined metal hoses	45
	- Hose assemblies for presses	46
	- High-pressure hoses for technical gases	47
	- Lance hoses for steel plants	49
	- Vibration absorbers	50
3.2	Vacuum technology / medical technology / optoelectronics	52
	- Vacuum hoses	52
	- Miniature hoses	52
3.3	Green energy	53
	- Solar hoses	53
	- Combined heat and power units	54
	- Flexible joints for solar panels	54
3.4	Heating and Ventilation	56
	- Hoses for kitchens and bathrooms	56
	- Drinking water feeder hoses	57
	- Gas hoses according to DIN 3384	58
	- HYDRA GS – gas hoses for buildings as per EN 15266	58
	- Gas hoses for household devices as per EN 14800	59
	- Equipment piping	61
	- Cooling ceiling hoses	62
	- Sprinkler mounting systems	63
	- Heat exchangers	64

3.1 Industry

Flexible heat tracing system

Trace heating is used to achieve constant temperatures in product pipelines, distributors, fittings, containers, pipe bridges and safety showers and to avoid frost damage. The type of energy supply differentiates electrical and thermal trace heating.

The HYDRA trace heating system shown in fig. 3.1.1 uses water or process steam as the heat carrier medium. It is available for the nominal diameters DN 12 to DN 25 and consists of a flexible trace heating hose, an insulated supply hose as well as accessory and fixing components. Trace heating hoses are available as goods sold by the metre and can be cut to length on site. It is connected with removable stainless steel or brass screw connections. Trace heating hoses are attached to the pipeline with quick-installation clips or with metal strips (see fig. 3.1.1). Wall mounting is possible using screwed-in quick installation clips.

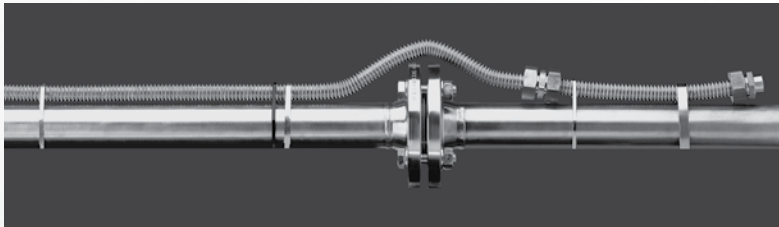

Fig. 3.1.1 HYDRA trace heating system

The advantages of the HYDRA trace heating system are:

- A simple and cost-effective installation without prior measurement of the pipeline and without welding or brazing work.
- Good adaptation to piping layout even with small bending radii,
- Minimal insulation costs via smaller moulded caps,
- Good heat transmission based on large corrugated surface and minimal wall thickness of the metal hose,
- High pressure, temperature, corrosion and aging resistance,
- Electrical conductivity, flame resistance and diffusion resistance.

3.1 Industry

If cold water is used as a heat transfer medium, the HYDRA trace heating system can also be used for cooling, e.g. for engines or exhaust gas pipelines.

Insulating hose assemblies

Insulating hoses provides for the flexible connection of heating devices with heating baths, chemical reactors and distillation plants.

The HYDRA insulating hose shown in fig. 3.1.2 is temperature-resistant to 300 °C. The high insulation performance ensures an external temperature of 60 °C is not exceeded for media temperatures up to 200 °C and this makes it safe to handle. The HYDRA insulating hose is vacuum- and diffusion-resistant with a permissible operating pressure of 12 bar at 20 °C. A DN10 annularly corrugated hose is used to convey media. The insulation has several layers on top is a silicon rubber hose. On request an additional braid of heat resistant Polyamit can be mounted. The insulation is held in position and sealed at both ends with shrink hoses. All welded connections can be manufactured burr-free and seamless.

The HYDRA insulating hose is very easy to install based on its pliability and the different lengths available. The hose is connected with stainless steel union nuts. The standard lengths are listed in chapter 6.4.



Fig. 3.1.2 HYDRA insulating hose

3.1 Industry

Double hose assemblies

HYDRA double hose assemblies consist of two coaxial metal hoses of different diameters. They can be used as heating, cooling or insulating pipelines or as monitored safety element. The working medium is conveyed via the inner hose. The annulus formed between the inner and outer hoses serves to convey the heat carrier or act as insulation or a monitoring space.

Double hose assemblies are used as heatable pipelines for conveying viscous or temperature-sensitive media in the chemical, petrochemical, pharmaceutical and food industries if insulating coatings are not sufficient to regulate the temperature or if restricted temperature tolerances have to be maintained. Double hose assemblies are used as a coolable element in compressor and engine construction for cooling air and for exhaust gases.

They are also used as insulating elements with the transmission of deep-frozen media, e.g. liquid gas in cryotechnology. The annulus between the inner and outer hose is evacuated.

If monitoring devices such as manometers or leak detectors are connected to the annulus the double hose assembly can also be used as a controllable safety element, e.g. for conveying dangerous media.



Fig. 3.1.3 HYDRA double hose assembly



Fig. 3.1.4 Cross-sectional view of a HYDRA double hose assembly.

3.1 Industry

Figures 3.1.3 and 3.1.4 show a HYDRA double hose assembly. Stainless steel corrugated hoses with stainless steel braid are used for the inner and outer tube. Flanges at both ends of the pipeline act as a connection for the working medium. Screw connections, welding neck flanges, vacuum small flanges or cryovalves are attached for the input and output of the heating and cooling media.

HYDRA traced hose pipelines have a high angular and lateral flexibility. They are pressure resistant, vacuum-tight, temperature-resistant and corrosion-resistant. Temperatures of up to 400 °C can be used in the standard version and up to 550 °C in the special versions. They are available in nominal diameters DN 10 to DN 150 and nominal pressure levels PN 16 and PN 40. Further dimensions and version details can be found in the technical tables in chapter 6.5.

Hose assemblies for chemical substances

In addition to the standards DIN EN 14585-1 and DIN ISO 10380, DIN 2827 describes hose assemblies made of stainless steel for chemical substances. One significant factor in the standard is corrosion protection. Burr-free and seamless connection technology is prescribed for nominal diameters DN 10 to DN 100. It is designed to avoid a localised concentration of corrosive media and resulting crevice and/or pitting corrosion. Welding work is to be performed by welders, certified according to DIN EN 287-1. The welding processes must conform to the requirements of the standards DIN EN ISO 15614. In addition, DIN 2827 describes integrated hoses or round wire coils as additional outer protective devices for metal hoses.

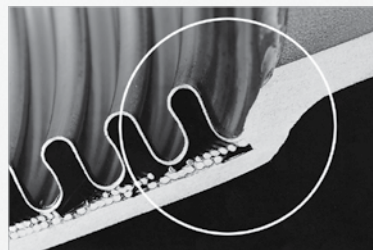

Fig. 3.1.5 Seamless and burr-free connection of a metal hose.

3.1 Industry

HYDRA annularly corrugated hoses can be produced from nominal diameter DN 6 as a special design in accordance with DIN 2827. The burr-free and seamless connection of braiding, annularly corrugated hose and end sleeves is shown in fig. 3.1.5. There is the option of fitting several protection devices according to DIN 2827 as shown in fig. 3.1.6.

The conveying of ammonia additionally demands meeting the safety requirements of TRD 451 and 452 i.e. the design pressure of the hose assembly must be bigger than PN 25 and flanges and sealings must be approved for ammonia. Such flanges are available on request.

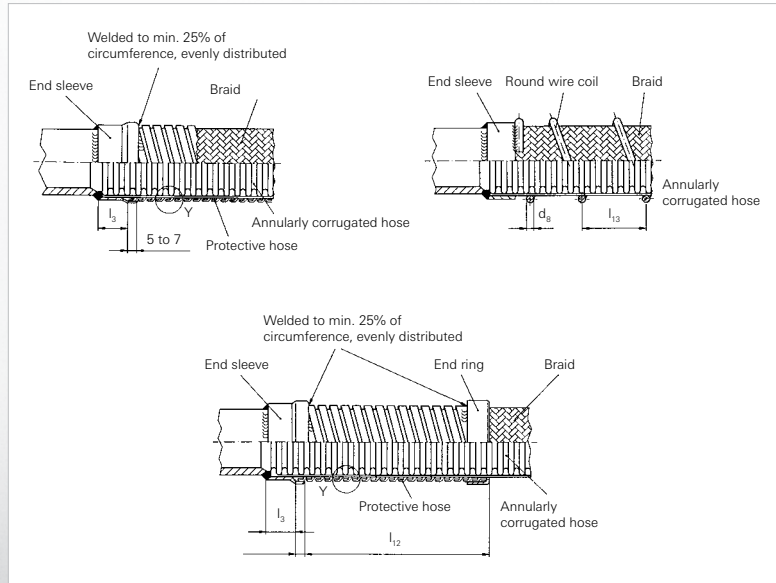

Fig. 3.1.6 Additional protection devices according to DIN 2827

3.1 Industry

Hose assemblies for foodstuffs

Cleanliness and hygiene are significant requirements for plants and aggregates in the food industry. The production process is regularly interrupted for cleaning cycles (CIP Cleaning in Place) to guarantee this. Open, not undercut corrugation profiles with large radii at the inner and outer crest are required to enable the effective and fast cleaning of metal hoses. The American 3-A Sanitary Standards contain the requirements for crest radii for flexible elements.

The RS 341 model from the range of HYDRA annularly corrugated hoses is ideally suitable for use in the food industry due to its wide corrugation. It can be welded burr-free and seamlessly with connection fittings on request, e.g with screw connection for liquid food according to DIN 11851.

PTFE lined metal hoses

PTFE-lined pipelines are used in the chemical industry if the corrosion resistance of metal materials is no longer sufficient. In addition, PTFE-lined hose assemblies are well suited as supply and filling hoses due to their smooth inner surfaces.



Fig. 3.1.7 HYDRA hose assembly with PTFE lining

Fig. 3.1.7 shows a stripwound hose with integrated profile, which is fitted internally with a PTFE liner. Outer braiding absorbs the longitudinal force resulting from the internal pressure and provides protection in combination with the stripwound hose against external mechanical loads. Welding rings and swivelling flanges made of steel or stainless steel serve as connection fittings on both sides. The PTFE liner also protects the sealing surface of the welding rings.

3.1 Industry

HYDRA hose assemblies lined with PTFE can be used in a temperature range of -40 °C to +230 °C. The standard dimensions are listed in the technical in chapter 6.5.

With the medium flow, electrostatic charges can occur on electrically non-conductive pipelines. Such charges can lead to the formation of sparks and possibly the ignition of gas and air mixtures. The PTFE lining must be able to conduct electricity in order to avoid charging. HYDRA - PTFE lined hose assemblies can be delivered with electrostatically conductive PTFE-lining on request. Adequate earthing is essential. Particular attention should be paid to the conductance of interference via electrical fields.

The PTFE lined metal hose is not suitable for the uncoupling of large vibration amplitudes.

Hose assemblies for presses

The manufacture of chipboard, MDF and OSB sheets and the surface coating of these sheets are completed at high temperature and high pressure. Multiple presses are used here with several sheets being processed over each other at a stroke.

Hot water, steam or thermal oil are used in the tempering of this process. They are fed to the individual layers of the press via metal hoses. The hoses compensate for the elevation movement of the press. They are installed in the U-bend configuration and are typically operated at 25 bar and 150 - 250 °C.

With a cycle time of several strokes per hour in three shift operation and a high availability of the machine, the press hoses have to bear several tens of thousands of load cycles per year. In order to ensure a smooth operation under these circumstances, the U-bend configuration should have adequate bending radius hose lengths and the pressure resistance of the hose assembly should not be fully utilised. Abrasion protection between the braiding and hose is advisable to minimise rubbing wear.

3.1 Industry

Hydraulically produced HYDRA RS 430 annularly corrugated hoses with double braid can be used as press hoses. Fig. 3.1.8 shows an example application. They can be fitted with space-saving rectangular or normal flanges, e.g. according to DIN 1092.



Fig. 3.1.8 Metal hoses in a multiple press.

High-pressure hoses for technical gases

Stainless steel corrugated hose assemblies are used to convey high-purity gases, technical gases under high pressure, dangerous or poisonous gases. Very high pressure is often used to achieve large volume flows and thereby short handling and filling times. The load configuration for metal hoses therefore encompasses a lot of pressure cycles in addition to frequent movements. In addition, a lot mounting and demounting leads to strain on the connection fittings.

HYDRA RS 531 DN 5 to DN 16 high-pressure hoses with double braid can be used for operating pressures up to 300 bar with these applications. Metal hoses for even higher operating pressure are currently being developed.

3.1 Industry

Fig. 3.1.9 shows a HYDRA RS 531 hose assembly as gas bottle filling hose. It is also clear to see the arresting cable as an additional safety element that prevents the chopping around of the hose in the event of a failure of the hose.

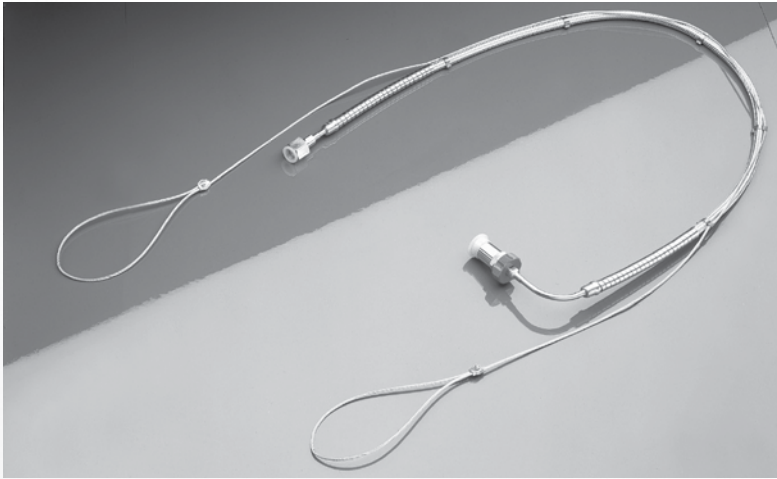

Fig. 3.1.9 HYDRA high-pressure hose for technical gases

The connections used for the individual gases are standardised according to DIN 477. In order to broadly exclude mistakes in filling and emptying, DIN 477 sets out for all flammable and easily ignited gases that the connections to the side connecting pieces of the gas bottle valve with left threads (LH) and for all other gases with right threads.

Table 3.1.1 names some of the most common gases and their allocation to the valve connections. In so far as gases other than those named in the table are to be filled, it is vital to check or find out about the suitability or the chemical stability of the filling hoses.

3.1 Industry

Connection fitting type	Connection to lateral lugs	Connection no.	Gases		WAF
–	d	–	–		mm
NR26S	W 21.80 x 1/14 LH	1	Ethylene, butadiene, butane, dimethyl ether, ethane, illuminating gas, methane, propane, hydrogen	flammable, easily ignited gases	30
	W 21.80 x 1/14	6	Ammonia, argon, helium, carbon dioxide (carbonic acid)	non-combustible or hard to ignite gases	30
	G 3/4	9	Oxygen		32
	W 24.32 x 1/14	10	Nitrogen		

Table 3.1.1 Allocation to gas bottle valve connections according to DIN 4771

Lance hoses for steel plants

During steel production, the raw iron produced in the blast furnace is turned into steel in a converter. Thereby, with the basic oxygen steel process, oxygen is blown onto the molten metal via a water-cooled lance at regular intervals. This enables the combustion of excess carbon and part of the unwanted accompanying elements. This process is also called 'refining'. The required elevation movement of the lance over several metres in vertical and horizontal directions is made possible via metal hoses, which are installed in the 180° bend. Cooling water and oxygen are fed in via separate hose assemblies.

Based on the large diameters and the high operating pressures, a hydraulically produced annularly corrugated hose RS 430 with doubled, knurled braid is used for lance hoses. An external integrated hose can be used as a mechanical protection.

Oxygen lines are also equipped with an inner integrated hose to improve the flow pattern and reduction of pressure loss. All components coming into contact with oxygen must be made of stainless steel and be free of oil and grease.

3.1 Industry

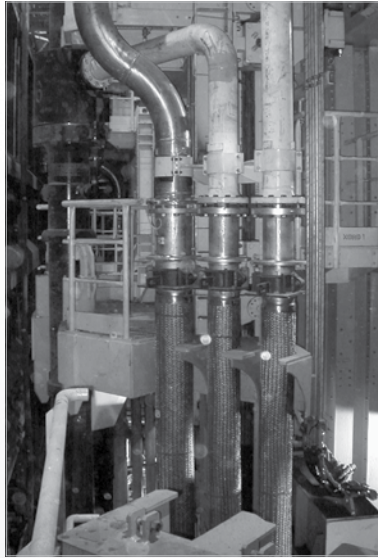

Fig. 3.1.10 Lance hoses for oxygen and cooling in the steel plant.

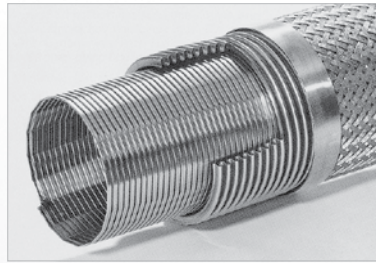
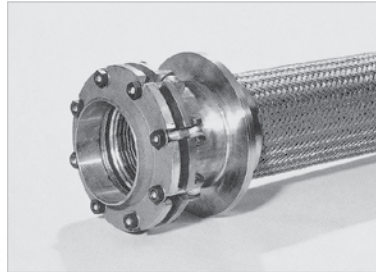

Fig 3.1.11 HYDRA annularly corrugated hose made of stainless steel with double braid and inner integrated hose as flexible oxygen feed for blow lance in steel plants.

Vibration absorbers

Vibration absorbers are used in supply lines in engines, pumps, cooling aggregates or air conditioning equipment to reduce the transfer of vibrations and muffle noises. One primary use is refrigeration engineering.

HYDRA vibration absorbers are made of bronze (DN 8 to DN 50) or stainless steel (DN 6 to DN 100). Better noise suppression is achieved with the bronze version.

3.1 Industry

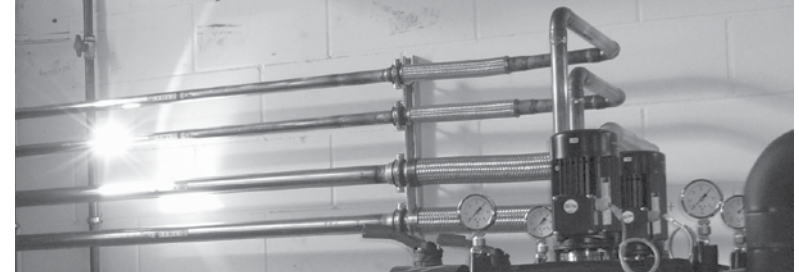

Fig. 3.1.12 HYDRA vibration absorber in use

The application of the vibration absorbers is shown in fig. 3.1.12. The correct installation is shown in fig. 3.1.13. The vibration direction must be perpendicular to the hose axis as braided hoses can only absorb movements in this direction. Multi-axis vibrations require the installation of 2 vibration absorbers. The hoses must be connected stress-free, flush and not pre-stressed. A fixed bearing is to be positioned directly behind the hose. The permissible amplitudes in constant mode are ± 1 mm, with switch on/off ± 5 mm.

The standard dimensions of the HYDRA vibration absorbers are listed in chapter 6.5. Alternatively, vibrations can also be absorbed with standard hoses in 90° bends. Further details can be found in chapter 4.6.

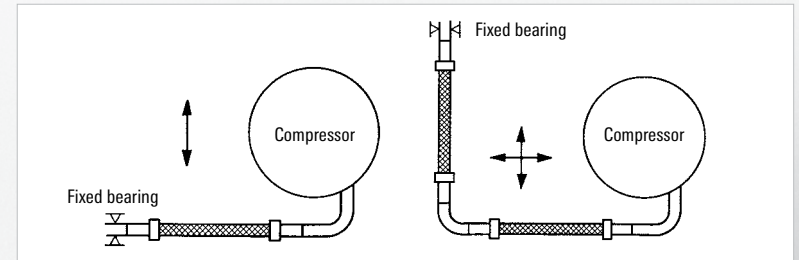

Fig. 3.1.13 Installation of HYDRA vibration absorber

Vacuum hoses

In vacuum technology, non-braided annularly corrugated hoses are typically used with standardised small flanges as quick-assembly hose assemblies for the connection of devices, pump, measuring equipment and test benches.

HYDRA annularly corrugated hoses without plastic seals can be heated up to 450 °C and can therefore be used in ultra high vacuum applications. If connections are used as small flanges, the hose assemblies can be used at pressures down to 10^{-9} mbar. If an external supporting ring is used in addition, then the vacuum flanges are used for inside over pressure up to approx. 1.5 bar.

HYDRA vacuum hose assemblies are usually subjected to a helium leak test with a leakage rate of 10^{-7} mbar l/s. Lower leakage rates can be confirmed on request.

Miniature hoses

HYDRA miniature hoses are used as protective hoses for instruments in minimally invasive surgery or for light conductors with laser or optoelectronic applications. Witzenmann is a leading manufacturer of miniature hoses with diameters of 1.5 mm to 6 mm. Both stripwound as well as pressure and diffusion-resistant annularly corrugated hoses are available. According to the particular application, the miniature hoses are coated, equipped with an inner liner or with special connections. HYDRA - miniature hoses are highly flexible, robust and resistant to aging.



Fig. 3.2.1 HYDRA miniature hoses

Solar hoses

Concentrated solar power plants with parabolic reflectors are today's most powerful plants for solar-thermal energy production. Parabolic reflectors are used in this sort of power plant to focus sunlight on the collector pipes and thereby heat the heat transfer medium circulating in it. Heat transfer oil, but also water/steam and, in the future, molten salt are used as heat carriers.

Steam is produced via heat exchangers and fed to a conventional power station. Alternatively, the direct vaporisation of water can occur in the collector pipe. One significant advantage of solar thermal power stations compared with photovoltaics is the possibility of the intermediate storage of thermal energy in molten salt.



Fig. 3.3.1 Solar field of a concentrated solar power plant

Fig. 3.3.1 shows the parabolic reflectors in a power station. During operation, they must be continually adjusted to the position of the sun. In addition, there are large thermal expansions between day and night. These expansions and movements must be balanced out via joints or flexible elements in the piping. One possibility is the connection of the collector pipes of the parabolic reflectors with metal hoses to the collecting pipes. Such solar hoses are exposed to high stress through the high temperatures and pressures as well as the big movements. Therefore, special structures made of multi-wall corrugated hoses with robust braiding are needed. In general, abrasion protection between corrugated hose and braiding, thermal insulation and possibly an outer protective hose may also be required.

Combined heat and power units

Combined heat and power units supply decentralised heating and electricity provision to buildings in accordance with the principle of combined power and heat. A fixed combustion engine runs at a constant engine speed, ideally in constant mode, and drives a generator that produces electricity. The combined heat and power units are very efficient through the use of waste heat from the engine used to heat domestic water. Depending on the operating conditions, over 90% of the supplied energy can be used.

In particular, the operation-related vibrations of the combustion engine poses great demands on the in- and output pipelines. With combined heat and power units HYDRA metal hoses are particularly suitable for conveying gas and water. On the one hand, they serve to remedy assembly faults and, on the other hand, the absorption of vibrations. At the same time, it compensates for constant vibrations with almost constant, small amplitudes in fixed, normal operation as well as the intensive, self-motion with high amplitude produced on all sides when starting and stopping the combustion engine.

Flexible joints for solar panels

Solar collectors for providing hot water consist of individual solar panels, which have to be connected to each other and the piping of the solar equipment. These connections must be so flexible that they can balance out the different thermal expansion of the individual components. HYDRA metal hoses and HYDRA metal bellows are used depending on the application and nature of the solar equipment.

Fig. 3.3.2 shows HYDRA solar connectors for different uses such as depressurised systems and pressurised systems, large plants or individual panels. Common technical features of all flexible connections for solar collectors are:

- Operating temperatures from -20 to +200 °C,
- Compensation of movement in all directions (axial, lateral and angular), where 10,000 load cycles have to be handled as a rule,
- A minimum number of sealing points,
- A non-brazed connection between the flexible component and a standard copper pipe.

HYDRA bellows and hoses are designed as pre-finished flexible connections for solar collectors and thereby enable quick and simple assembly without special previous knowledge.

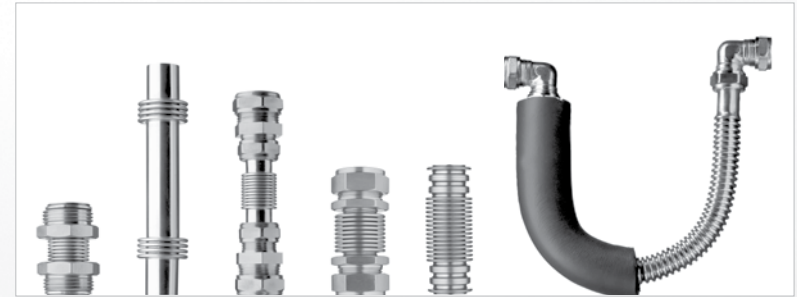

Fig. 3.3.2 HYDRA metal bellows and hoses for flexible connections of solar collectors.

3.4 Heating and Ventilation

Hoses for kitchens and bathrooms

Metal hoses are in everyday use as shower hoses in kitchens and bathrooms. Under the brand name ASPOR, Witzemann produces nickel-plated and chromium-plated shower hoses and accessories. ASPOR hoses are designed for professional everyday use at operating temperatures up to 70 °C. They can be used for drinking water, are flexible, resistant to torsion, tension-proof in axial direction and have a high transverse compression strength. ASPOR hoses are approved according to:



The ASPOR design line (fig. 3.4.1) is an eye catcher for the bathroom and kitchen with its square or triangular shower hoses.

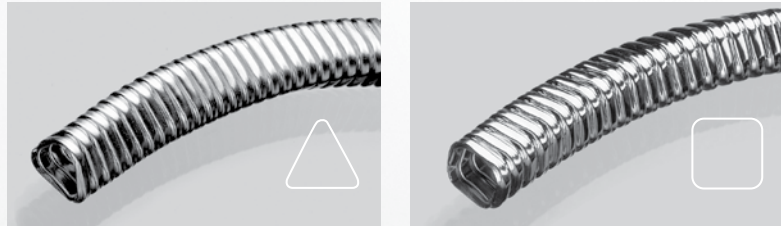

Fig. 3.4.1 ASPOR design line

The kitchen shower head type GB 1 (fig. 3.4.2) is used in shower head systems in commercial kitchens in restaurants, canteens, clinics etc. The maximum permissible operating pressure is 16 bar, the hose can be used for drinking water and is temperature-resistant up to 90 °C. An external feature is the stable protective integrated hose made of stainless steel 1.4301. The inner hose is made of butyl rubber and is KTW approved. It is connected on both sides via chromium-plated G 1/2" brass union nuts.

3.4 Heating and Ventilation



Fig. 3.4.2 Kitchen shower head type GB 1

Drinking water feed pipes

Drinking water feed pipes are used in domestic premises and in the catering trade for the connecting washing machines and dishwashers, fridges with ice cube facility, steam cookers as well as coffee and espresso machines. Fig. 3.4.3 shows HYDRA drinking water feed pipes of the HY line with different connection fittings. The structure of these hoses a pressure-tight annularly corrugated hose inside and an integrated hose as mechanical protection, is represented in fig. 3.4.4. Based on the hose diameter and corrugated profile, a turbulent flow develops in the annularly corrugated hose. This significantly reduces the deposits of lime or bacteria and also has a cleaning effect.

HYDRA drinking water feed pipes are supplied with the standardised connection fittings with G 3/4" threads. They are DVGW-approved for drinking water use according to VP 543 as well as according to KTW for flat sealings.



Fig. 3.4.3
HYDRA drinking water feed pipes



Fig. 3.4.4 structural design of
HYDRA drinking water feed pipes

3.4 Heating and Ventilation

Gas hoses according to DIN 3384

Industrial gas consumer units may be connected with hose assemblies made of stainless steel in accordance with DIN 3384. The nominal diameter of the hose assemblies must not exceed DN 300 and operating pressure PN 16. Pipelines must not be laid in the ground. The materials, design, factory tests and approvals for gas hose assemblies are described in DIN 3384.

HYDRA – annularly corrugated hoses type RS 331 L00 and L12 in the nominal diameters DN 6 to DN 150, RS321 L00 and L12 to DN 50 and RS 341 L00 and L12 to DN 100 are approved by the DVGW as gas hose assemblies. The hose assemblies LA230 with threaded connections according to DIN EN 10226-1, LA201 with flanges according to DIN EN 1092-1 and LA241 with welding ends are available as standard. In addition, HYDRA annularly corrugated hoses with other fittings, permitted according to DIN 3384, can be used at any required length.

HYDRA GS – Gas hoses for buildings as per EN 15266

As long as the working pressure does not exceeds 0.5 bar, gas installations in buildings can be completed quickly and cheaply with non-rusting pliable corrugated pipe sets according to EN 15266. The HYDRA GS installation system consists of a coated annularly corrugated hose based on RS 351 with appropriate self-assembly connectors and installation accessories. The system also includes a tool box with the separating and assembly tools shown in fig. 3.4.5 on the left for cutting the pipeline to length and for assembling the connectors.

One advantage of the HYDRA GS system is the minimal installation costs. The gas pipeline is available as rolled goods and is cut to length on site. The pipework system can be adjusted to the structural circumstances by bending by hand. The fittings are mounted within seconds using the assembly tool.

3.4 Heating and Ventilation

HYDRA GS is available in the nominal diameters DN 16 to DN 32 and is a DVGW-approved gas installation system.

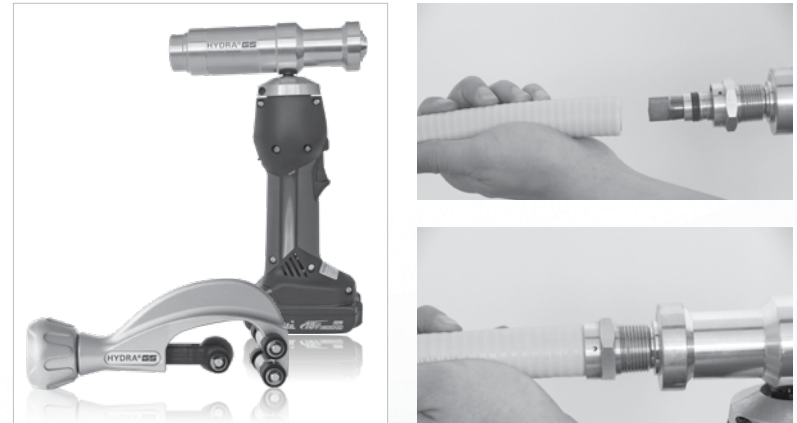

Fig. 3.4.5 HYDRA GS gas installation system, tools on the left and installation of a threaded nipple on the right.

Gas hoses for domestic appliances according to EN 14800

Metal hose assemblies can be used to connect household appliances such as gas stoves, terrace heaters or terrace barbecues inside and outside the property if the gas pressure is less than 0.5 bar. EN 14800 sets out the requirements for usability, materials and test procedure for gas hoses for connecting gas-powered household appliances. In the future, it will replace the different country-specific standards in Europe and will lead to a uniform safety standard.

3.4 Heating and Ventilation

The gas hoses in the HYDRAGAS GA 7xx line were developed based on the requirements of EN 14800. Fig. 3.4.6 shows its three-level structure: an inner, annularly corrugated hose provides the gas supply and leak tightness, stainless steel braiding absorbs mechanical loads, an easy-clean external PVC coating provides protection against dirt and aggressive household cleaning agents. The annularly corrugated hose, braiding and connectors are welded together. The PVC coating is pressed onto the connection fittings with stainless steel end sleeves and are slip-resistant and sealed against moisture at connection fittings.

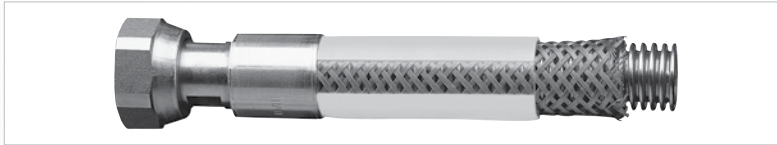

Fig. 3.4.6 Three-level structure of HYDRAGAS GA 7xx gas hoses

The colour of the PVC coating denotes the type of gas and the country where it is used. The connection fittings are suitable for country-specific, common oven connections and gas fittings and enable trouble-free mounting of the gas hose. The minimum permissible bending radius is 40 mm.

All the gas hoses in the HYDRAGAS GA 7xx line have a CE approval, according to DIN EN 14800. The performance data is regularly checked in component tests. The labelling of the end sleeves enables clear traceability and batch assignment.



Fig. 3.4.7 Different country-specific versions of HYDRAGAS GA 7xx

3.4 Heating and Ventilation

Equipment piping

Semi-flexible, annularly corrugated hoses with a flat profile are used for cost-effective pipework in charging pumps, boilers, expansion vessels, stratified tanks or gas appliances. A single bend of the hose is often required here to create the desired installation configuration. The semi-flexible hose is reshaped and fixed in the set position when bent. Further advantages of the flat profile include low costs and relatively small pressure loss. Fig. 3.4.8 shows a semi-flexible annularly corrugated hose in bent position; fig. 3.4.9 shows a boiler as a sample installation.

HYDRA HX 441 and IX 331 annularly corrugated hoses are ideally suited to equipment pipework. The easily-pliable HX 441 is ideal for narrow bending radii and multiple bending, the semi-flexible IX 331 with patented corrugation shape has a very high flexural stiffness and therefore remains reliably in its bent position. The hoses are available as goods sold by the metre or as pre-bent pipelines ex works. Insulation is provided with PE or EPDM over the whole length of the hose. The semi-flexible pipework of the gas installations must also conform with the requirements of DIN EN 15266.



Fig. 3.4.8 Semi-flexible annularly corrugated hose in bent position



Fig. 3.4.9 Sample installation of device pipework with flexible annularly corrugated hoses

Cooling ceiling hoses

Cooling ceilings are used for air conditioning in buildings using cold water. They are made up of individual panels, which can be removed for repair and maintenance work. Fig 3.4.10 shows an exposed cooling ceiling. The cooling ceiling hoses used to supply water to the panels can clearly be seen.

HYDRA annularly corrugated hoses RS 321, RS 331 or RS 341 can be used as cooling ceiling hoses, regardless of the mounting situation or required bending radii. Standard versions are hose assemblies with double-sided flat-sealing hose rims, brass union nuts, asbestos-free sealing and sealed plug-in connector. Alternatively, screw-in components with brass internal and external threads or screw-in parts with brass supports (suitable for plug-in connector DN 10 / DN 12) are also available.

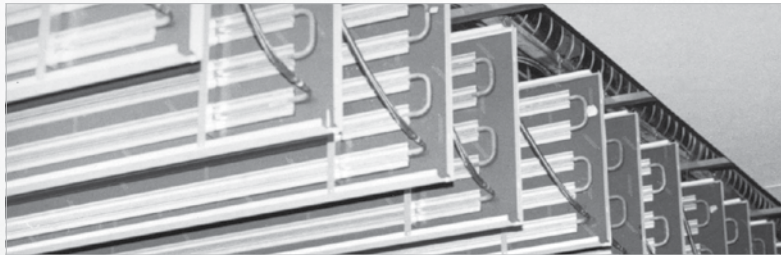

Fig 3.4.10 Exposed cooling ceiling with flexible connecting lines

HYDRA cooling ceiling hoses enable cost-effective and flexible mounting without brazing or welding. The line is supplied as a set, i.e. subsequent sealing of the connectors is not required. The high lateral pressure of the annularly corrugated hose and the patented, extra buckle-resistant hose ends prevent constriction of the cross-section and increase in flow resistance on bending. HYDRA cooling ceiling hoses are resistant to diffusion and thus guarantee trouble-free operation of the control devices. Corrosion caused by oxygen diffusion or accumulation of mud on the line is also avoided.

Sprinkler mounting systems

The exact mounting of sprinklers in suspended ceiling systems using conventional mounting methods is very laborious: the traditional "lining up" using rigid piping as per the predefined ceiling plan is very time consuming and costly. The use of the HYDRA sprinkler mounting system with specially-designed stainless steel hoses significantly reduces installation work, as the flexibility of the hose enables the sprinkler to be installed in any position within the circular area determined by the hose length. The supplied mounting brackets allow reliable and secure attachment of the sprinkler hose to the substructure of the appropriate ceiling system. The use of a HYDRA sprinkler mounting system instead of fixed pipework reduces installation time by up to 80 %.

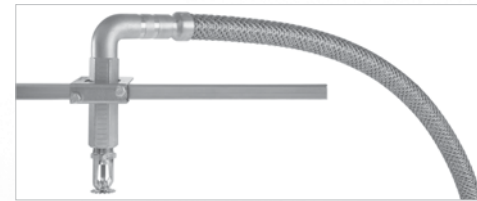

Fig. 3.4.11 HYDRA sprinkler mounting system

Standard HYDRA sprinkler brackets are based on the use of a square pipe 15 x 15 mm as a transverse beam. The HYDRA sprinkler hose is secured with a sprinkler clamp variably positioned to the square pipe as shown in fig. 3.4.12. Various sprinkler mounting systems are available, adapted to the individual construction of the suspended ceiling.



Fig. 3.4.12 Mounting a HYDRA sprinkler hose

3.4 Heating and Ventilation

HYDRA sprinkler mounting systems are recognised by the VdS (Association of Damage Insurers of Germany) and are approved for use in sprinkler wet systems with sprinklers R 3/8" (K 57), R 1/2" (K 80) and R 3/4" (K 115) in the pressure level PN 16. The approval is only valid in connection with the ceiling systems specified in our technical product descriptions. FM-approved sprinkler mounting systems are available in the pressure level PN 12 (175 psi) for sprinklers R 1/2" (K80) and R 3/4" (K 115). The sprinkler mounting systems also have CNPP (France) and CNBOP (Poland) approvals.

Heat exchangers

Heat exchangers with corrugated pipes offer several advantages compared with traditional straight-tube heat exchangers:

- The large surface of the corrugated metal hose enables good heat transmission,
- Combined with the ribbed structure, it promotes condensation, e.g. for systems with condensing boiler technology,
- The turbulent flow increases heat transmission and reduces the build-up of lime deposits,
- The double-curved shell structure enables compact and light design.

This means that the efficiency level of a compact heat exchanger with corrugated pipes for special applications may be greater than a comparable straight-tube heat exchanger. Typical fields of compact heat exchangers are the heating of drinking, service or swimming pool water, temperature control of circulating water, system separation in underfloor heating or exhaust gas cooling and condensation.

Heat exchangers with stainless steel corrugated pipes can be used at a wide range of temperatures. It ranges from 90 °C for swimming pool heat exchangers to over 1000 °C as a primary heat exchanger in hot working areas. Such heat exchangers also have to be resistant to temperature shocks.

As a system producer, Witzenmann offers heat exchangers with customised housings.

3.4 Heating and Ventilation

Housings and heat exchanger coils are matched to achieve optimum efficiency of the heat exchanger. Figures 3.4.13 and 3.4.14 show sample models.

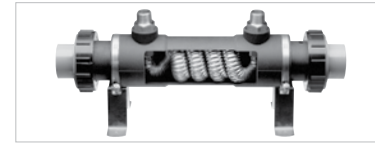

Fig. 3.4.13 Swimming pool heat exchanger with plastic housing



Fig. 3.4.14 Compact heat exchanger with corrugated pipe coil (left) and corrugated pipe bundle (right).

In addition, Witzenmann also produces a stratified tank coil shown in fig. 3.4.15. They have a patented bracket system for self-supporting installation. Stratified tank coils are available as complete systems with connectors in a range of sizes.



Fig. 3.4.15 HYDRA stratified tank coil

DESIGN, CALCULATION AND INSTALLATION FOR CORRUGATED HOSES

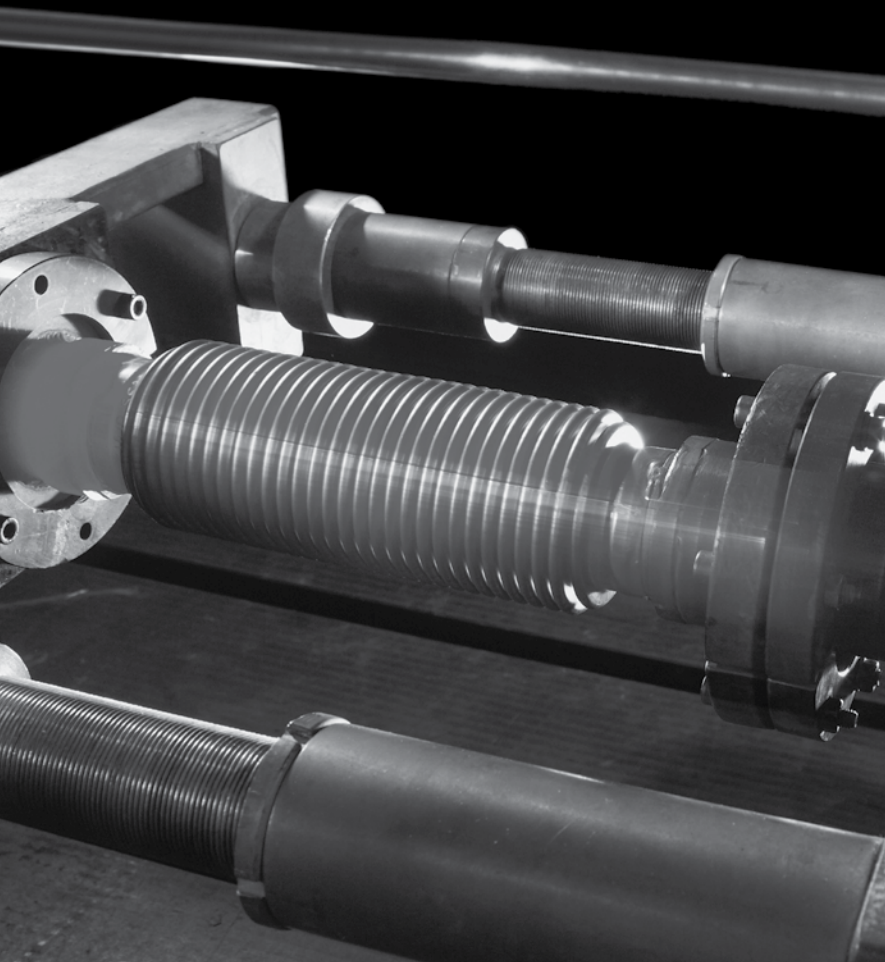

4. Design, calculation and installation for corrugated hoses

4.1	Pressure resistance and service life	68
4.2	Pressure loss and flow-induced vibrations	76
4.3	Absorption of movements	87
4.4	Absorption of thermal expansions	91
4.5	Compensation of mounting tolerances and pipework offset	97
4.6	Absorption of vibrations	98
4.7	Installation and assembly instructions	100

4.1 Pressure resistance and service life

The main requirements for corrugated hoses are

- (1) Media and corrosion resistance,
- (2) Temperature resistance,
- (3) Leak tightness,
- (4) Pressure resistance,
- (5) Flexibility and service life.

Corrosion and temperature resistance can be achieved by selecting the appropriate materials. The permissible pressures at higher working temperatures are defined by reduction factors (cf. chapter 6.1). Tightness is guaranteed by the production process. The selection of a suitable hose design is decisive for the pressure resistance and service life and service life.

With non-braided hoses, the pressure resistance and service life can easily be forecast via parallel use of the calculation rules known for metal bellows on the corrugated structure of the hose. This particularly applies if the bending line of the hose is described, taking account of the internal pressure, in accordance with

$$w''''(x) + \frac{p \cdot A}{EI} w''(x) = 0 \quad (4.1.1)$$

As the use of non-braided hoses is not the norm due to their limited pressure resistance and service life, we refer to further details in the standards EJMA 2009, EN 14917, the "Metal bellows handbook" as well as the publication "Design, service life and reliability of metal bellows for valve spindle sealing" (Armaturen-welt 2011, issues 2, 3 and 4).

The behaviour of braided hoses is determined via the interaction of corrugated hose and braiding. This is only analysed in part, meaning that the design of braided metal hoses is strongly based on an experimental approach. DIN EN ISO 10380 provides regulations for standardised experimental procedures. The bursting test and the durability test are critical for braided hoses.

4.1 Pressure resistance and service life

Bursting of the hose

Failure modes in burst tests are the bursting of the hose under the braiding shown in figure 4.1.1 or the braiding failure through longitudinal forces represented in figures 4.1.2 and 4.1.3.

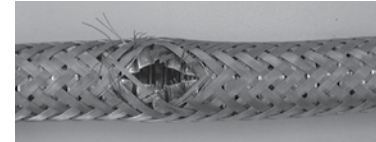

Fig. 4.1.1 Bursting of hose under the braiding



Fig. 4.1.2 Braiding failure and resulting ruptured hose

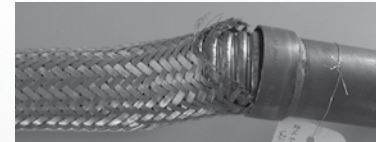

Fig. 4.1.3 Braiding failure at the interface to the end pants

The hose bursts under the braiding if the braiding is more strongly dimensioned than the annularly corrugated hose. The hose fails due to circumferential stress caused by the operating pressure and attenuated by the radial support of the braiding. The rupture of the hose is in an axial direction. A medium circumferential stress of σ_{um} can be used as an arithmetical failure criterion for the bursting of the annularly corrugated hose. The bursting safety of the annularly corrugated hose S_{BR} arises from the comparison of the mean circumferential stress σ_{um} with the tensile strength $R_m(T)$ of the hose material at the working temperature.

$$S_{BR} = C_w \frac{R_m(T)}{\sigma_{um}} \quad (4.1.2)$$

4.1 Pressure resistance and service life

The weld seam factor C_w takes account of the possible reduced strength of the longitudinal seam compared to the basic material of the outlet pipe.

A braiding failure occurs if the tensile stress σ_z in the individual wires exceeds the tensile strength of the wire material $R_m(T)$. Braiding failure is usually followed by a stretching and ultimate bursting of the annularly corrugated hose at the defective spot. The cracks are orientated to the peripheral direction.

The safety factor against braiding failure S_{BG} is

$$S_{BG} = \frac{R_m(T)}{\sigma_z} \quad (4.1.3)$$

If the tensile strength of the braiding wires is reduced by excessive heat input during the braiding process, a localised weak point appears on the hose and failure takes place as shown in figure 4.1.3 on the interface of the hose, braiding and endparts. The tensile strength of the braiding wire has to be reduced accordingly to enable the correct calculation of the bursting strength.

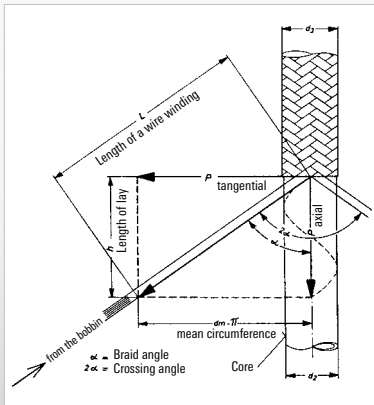

Fig. 4.1.4 Geometry of the hose braiding

4.1 Pressure resistance and service life

The braiding is stressed in an axial direction by the pressure reacting-force of the hose. The braiding geometry detailed in figure 4.1.4 produces tensile stresses σ_z in the individual braiding wires

$$\sigma_z = \frac{F}{n_k \cdot n_D \cdot A_D \cdot \cos \alpha} \quad (4.1.4)$$

$F = p \cdot A_{hyd}$: pressure reacting-force

n_D : number of wires per clapper

n_k : number of clappers

α : braiding angle opposite the vertical

A_D : cross-sectional area of a braiding wire

σ_z : tensile stress in an individual braiding wire

Not all wires are uniformly loaded with multi-layered braiding made with a constant length of lay. Here the braiding angle increases from the inner to the outer braiding. Therefore, load capacity does not increase in proportion to the number of layers. According to DIN EN 10380 this increases the load capacity:

- Double braiding to 1.8x and
- Triple braiding to 2.6x of the value of the individual braiding

In practice, this estimation applies well to hoses of small nominal diameters. With larger hoses the effect is less pronounced. The equations 4.1.2 and 4.1.3 allow the forecasting of the failure mode of the hose assembly and a balanced arrangement of annularly corrugated hose and braiding with regard to bursting. DIN EN ISO 10380 requires a bursting strength $S > 4$, i.e. $S_{BR} > 4$ and $S_{BG} > 4$ for metal hoses. Due to the uncertainty of the strength values, the evidence of bursting strength must always be provided experimentally. If hoses are used at increased temperatures, the permissible pressure falls in accordance with the decrease in the stability characteristic values of the hose and braiding material. The appropriate reduction factors are listed in table 6.1.2 in chapter 6.1.

4.1 Pressure resistance and service life

Service life in the U-bend test

The U-bend test is the standardised life cycle test for hose assemblies with small and medium nominal diameters (DN). Fig. 4.1.5 shows the theoretical installation configuration. The significant test parameters are pressure (p), bending radius (r), elevation (y) and the flexible length of the hose (L_1). It is defined according to

$$L_1 = 4 \times R + x \quad (4.1.5),$$

whereby x is four times greater than the nominal diameter, but at least 125 mm. The corresponding bending radii are listed in table 4.1.1. With these bending radii, the HYDRA hose assemblies listed in chapter 6.3 achieve a service life of 10,000 alternations of load in a U-bend test, in accordance with DIN EN ISO 10380.

In the practical tests, the bending line differs from the U shape with parallel flanks. Fig. 4.1.6 shows an example of the self-setting horseshoe-shaped hose configuration. This variation from the U shape increases with rising internal pressure and falling flexural stiffness of the hose and leads to an increased load and near the fixing points.

Therefore, fatigue fractures of the hose and/or braiding on or near the fixing points are one of the typical failure modes in the U-bend test.

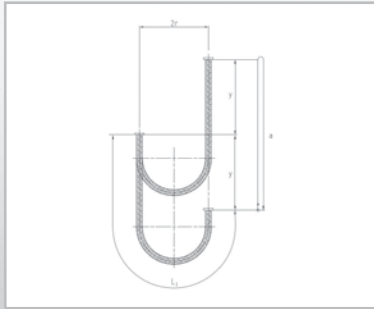

Fig. 4.1.5 U-bend test, theoretical bending line.



Fig 4.1.6 Bend curve in the U-bend test under internal pressure.

4.1 Pressure resistance and service life

Nominal diameter DN	Nominal bending radius r_N [mm] for hoses with high flexibility (type 1)	Nominal bending radius r_N [mm] for hoses with normal flexibility (type 2)
4	100	120
6	110	140
8	130	165
10	150	190
12	165	210
15/16	195	250
20	225	285
25	260	325
32	300	380
40	340	430
50	390	490
65	460	580
80	660	800
100	750	1000
125	1000	1250
150	1250	1550
200	1600	2000
250	2000	2500
300	2400	3000

Table 4.1.1 Bending radii for the U-bend test according to DIN EN ISO 10380:2013

Other possible failure modes include rubbing wear of the hose through the relative movement of hose and braiding or a localised backing of the hose in the transitional area between the bent and straight sections. Localised buckling occurs most often with pliable hoses with a large nominal diameter.

4.1 Pressure resistance and service life

The magnitude and expression of the rubbing wear shown in fig. 4.1.7 depend strongly on the pressure, braid structure and presence of lubrication or of abrasion protection. A guide value for tests with nominal pressure is that, with load cycles endured under 10,000 alternations of load, the fatigue of hose or braid and, with load cycles endured over 200,000 alternations of load, the rubbing wear of the hose determine failure. Inbetween both sorts of failure occur.

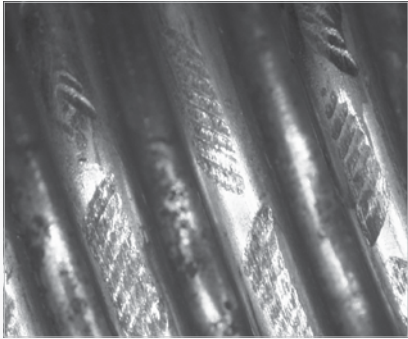

Fig. 4.1.7 Braiding friction marks on an annularly corrugated hose

Due to the many different methods of failure, it is impossible to produce an arithmetical service life prediction for braided corrugated hoses. The comparison of the maximum curves of the bending line can be used in tests and use to provide a very rough evaluation of the behaviour of a hose in an installation configuration deviating from the test.

4.1 Pressure resistance and service life

An increase in the bending radius, an extension of the hose length and reduction in pressure can generally be seen as a way to extend the life-time. One example of this is: Fig. 4.1.8 test results of the HYDRA annularly corrugated hose, RS 331 S12 DN 25. With the same movement, the load cycles endured increases from 30,000 cycles at nominal pressure to up to several million load cycles with pressure-free operation.

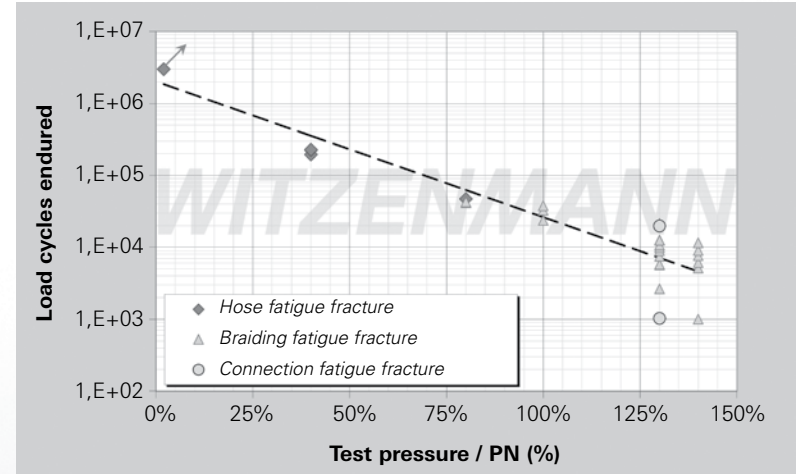

Fig. 4.1.8 Dependency on the load cycles endured in the U-bend elbow test on the relationship between test pressure and nominal pressure.

4.2 Pressure loss and flow-induced vibrations

With the development of line systems for conveying liquid or gaseous media, pressure loss plays an important role in design. With metal hoses, there is always a greater pressure loss than in smooth pipelines at the same flow volumes and flow velocities, on account of the geometry of the corrugation.

The pressure loss is determined by the hose geometry, the flowing medium and the flow conditions. According to the Reynold's number

$$Re = \frac{c \cdot d_i}{\nu} \quad (4.2.1)$$

the schematically represented flow conditions in fig. 4.2.1 can occur in corrugated hoses:

1. The laminar zone – a laminar flow forms in the cylindrical area of the hose, the corrugations are not covered by the flow
2. The zone of turbulence – primary and secondary vortices form in the corrugated spaces, but the central flow is not affected (see also fig. 4.2.2),
3. The high velocity zone – the turbulence flags between the inner crests have a reciprocal effect on each other and they affect the central flow.

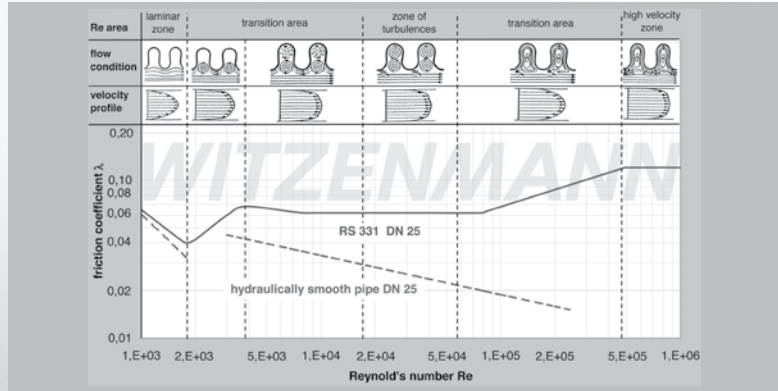

Fig. 4.2.1 Flow formation and coefficient of friction in the corrugated hose as function of the Reynold's number (schematic)

4.2 Pressure loss and flow-induced vibrations

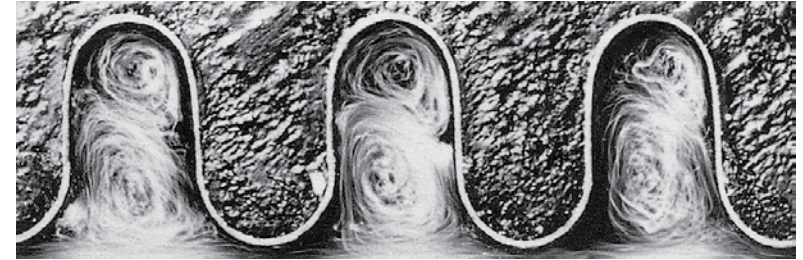

Fig. 4.2.2 Turbulent flow with undisturbed central flow as well as primary and secondary vortices in the corrugation in an annularly corrugated hose.

In the first approximation, it can be assumed that the pressure loss in corrugated hoses with a turbulent flow is almost 2½-times and, with a high-speed flow, is some 5½-times as big as new, welded steel pipes. In order to compensate for the increased pressure loss, the inside diameter of the corrugated hose has to be 20 % or 40 % bigger than the hydraulically smooth pipe.

The pressure loss Δp can be calculated according to

$$\Delta p = \left(\lambda \frac{L_i}{d_i} + \zeta_b \right) \cdot \frac{\rho}{2} c^2 \quad (4.2.2)$$

This involves:

λ = the coefficient of friction,

L_i = the corrugated hose length,

d_i = the inside diameter of the hose,

$\zeta_b = \zeta \frac{\alpha}{180^\circ}$ the resistance coefficient for a curved installation of the hose with the bending angle α ,

ρ = the density of the fluid and

c = the flow velocity.

4.2 Pressure loss and flow-induced vibrations

The coefficients of friction λ and the resistance coefficients ζ for a 180° bend were determined experimentally at Witzenmann. For the most important hose types, they are represented as a function of the Reynold's number or as function of the relation of bending radius r to the inner diameter d_i of the hose in figures 4.2.3 to 4.2.10.

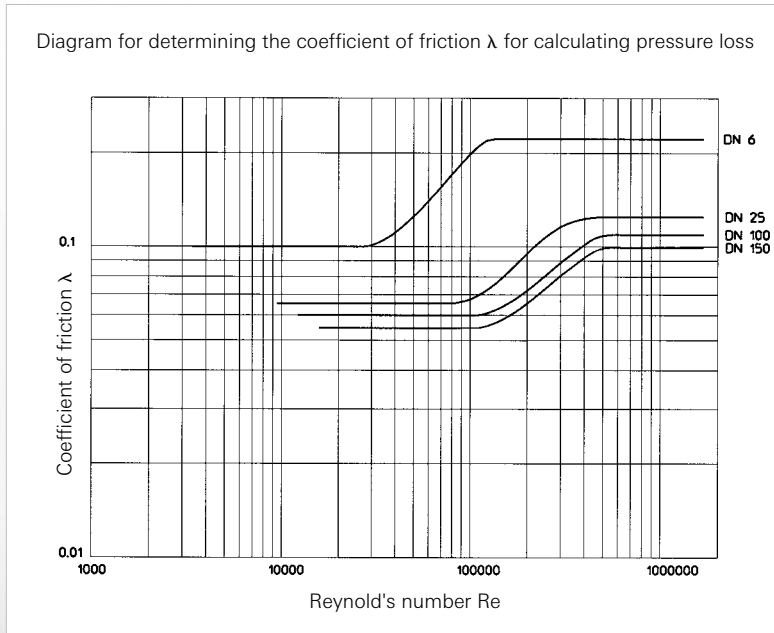

Fig. 4.2.3 Coefficient of friction λ for HYDRA metal hoses RS 331/330

4.2 Pressure loss and flow-induced vibrations

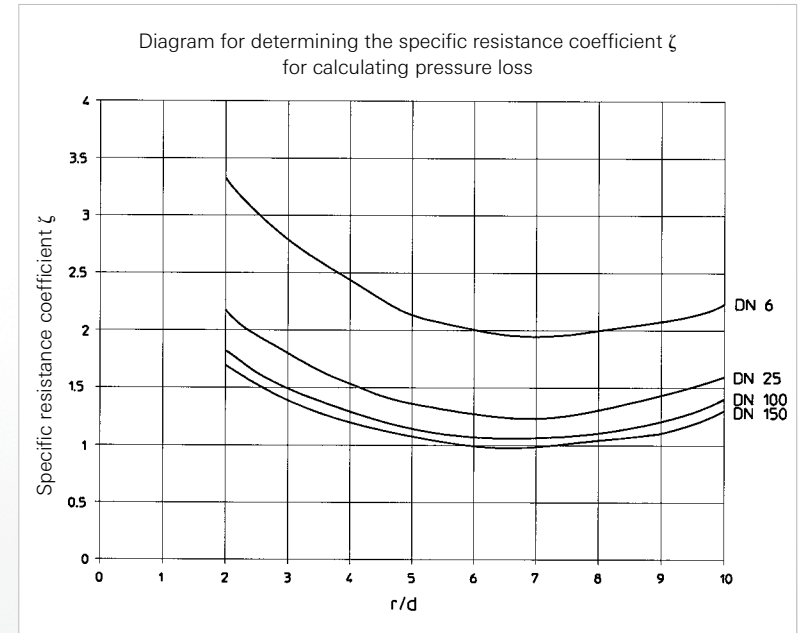

Fig. 4.2.4 Specific resistance coefficient ζ for HYDRA metal hoses RS 331/330

4.2 Pressure loss and flow-induced vibrations

Diagram for determining the coefficient of friction λ for calculating pressure loss

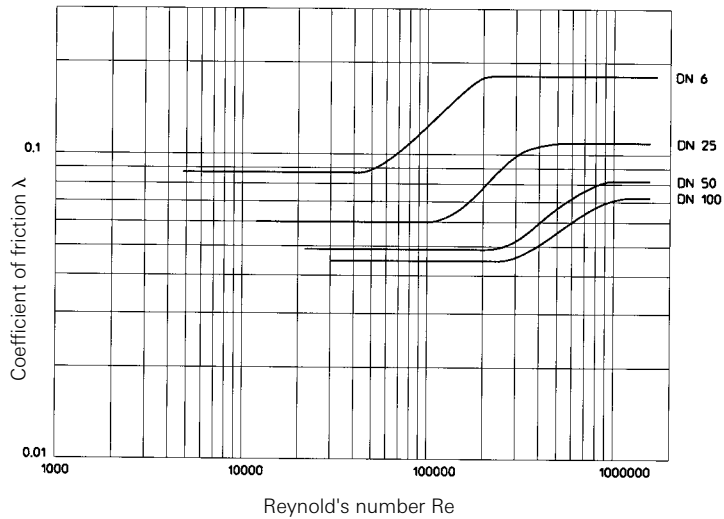

Fig. 4.2.5 Coefficient of friction λ for HYDRA metal hoses RS 321

4.2 Pressure loss and flow-induced vibrations

Diagram for determining the specific resistance coefficient ζ for calculating pressure loss

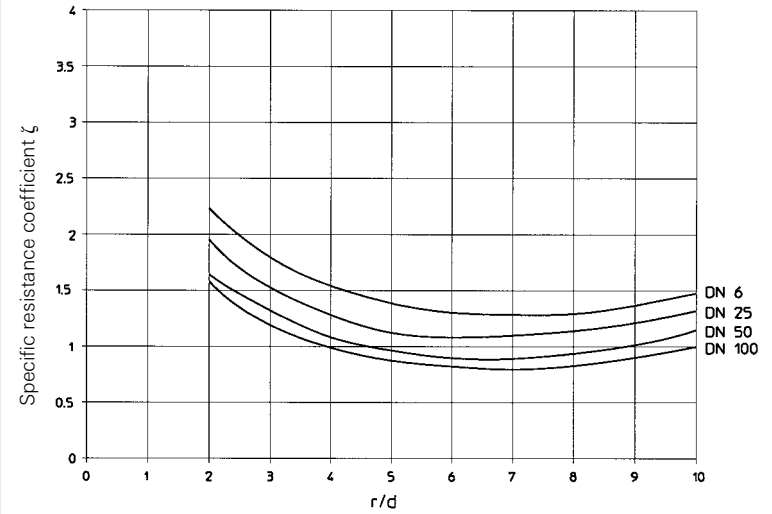

Fig. 4.2.6 Specific resistance coefficient ζ for HYDRA metal hoses RS 321

4.2 Pressure loss and flow-induced vibrations

Diagram for determining the coefficient of friction λ for calculating pressure loss

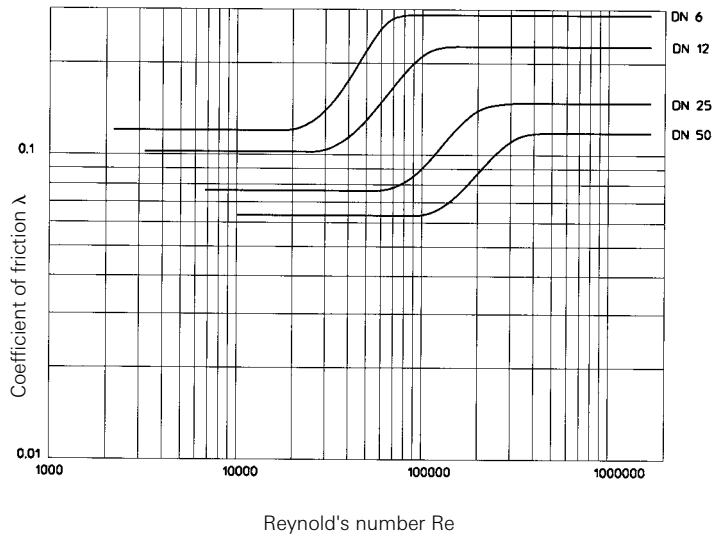

Fig. 4.2.7 Coefficient of friction λ for HYDRA metal hoses RS 341

4.2 Pressure loss and flow-induced vibrations

Diagram for determining the specific resistance coefficient ζ for calculating pressure loss

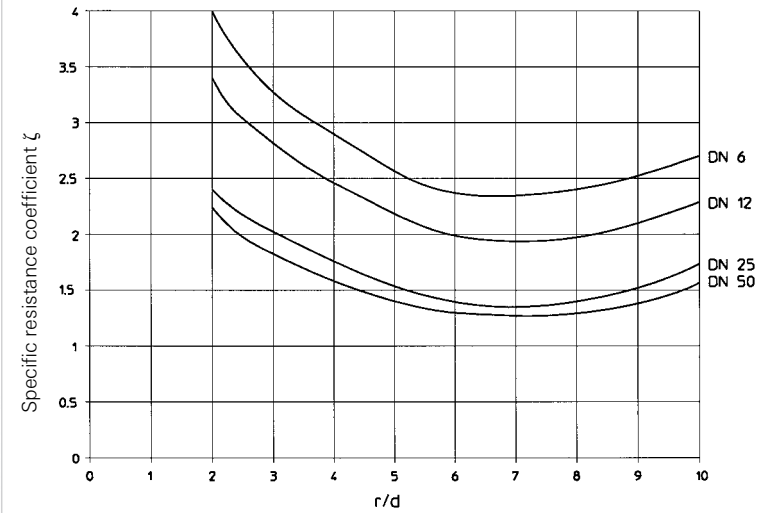

Fig. 4.2.8 Specific resistance coefficient ζ for HYDRA metal hoses RS 341

4.2 Pressure loss and flow-induced vibrations

Diagram for determining the coefficient of friction λ for calculating pressure loss

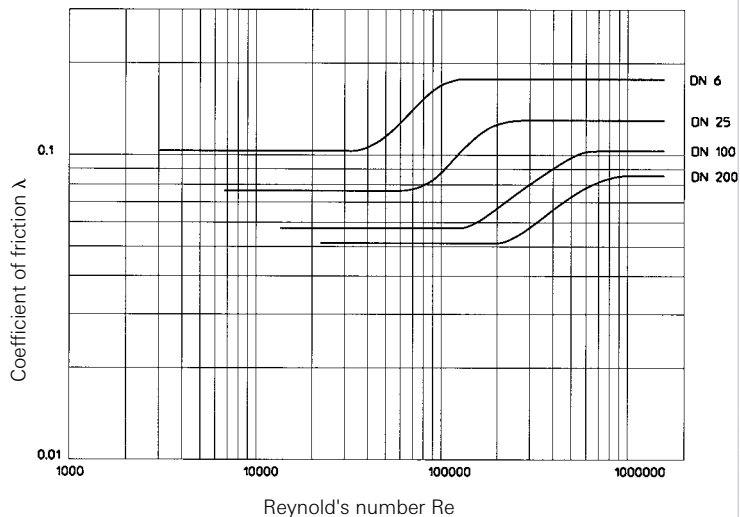

Fig. 4.2.9 Coefficient of friction λ for HYDRA metal hoses RS 531/430

4.2 Pressure loss and flow-induced vibrations

Diagram for determining the specific resistance coefficient ζ for calculating pressure loss

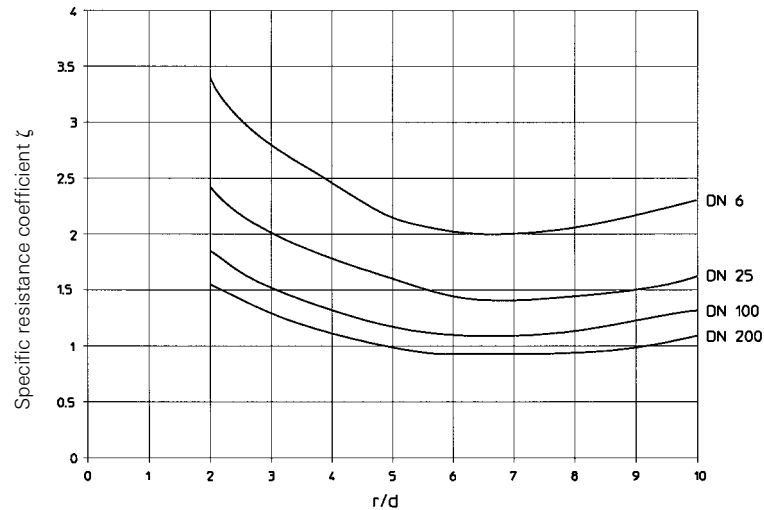

Fig. 4.2.10 Specific resistance coefficient ζ for HYDRA metal hoses RS 531/430

4.2 Pressure loss and flow-induced vibrations

The following example calculation demonstrates the determination of pressure loss:

Medium:

Organic heat carrier

Flow velocity: $c = 1 \text{ m/s}$

Operating temperature: $t = 300 \text{ °C}$

Thickness at operating temperature: $\rho = 827 \text{ kg/m}^3$

Kinematic viscosity at operating temperature: $\nu = 0.5 \cdot 10^{-6} \text{ m}^2/\text{s}$

Installation conditions:

Hose type: RS 331 DN25

Hose inner diameter: $d_i = 25.5 \text{ mm}$

Hose length: $l_f = 1300 \text{ mm}$

Deflection angle: $\alpha = 90^\circ$

Bending radius: $r = 260 \text{ mm}$

The pressure loss in Pa is sought.

Solution:

1. Determination of the Reynold's number: $Re = \frac{c \cdot d_i}{\nu} = 51000$
2. Reading off of coefficient of friction $\lambda = 0.067$ and the resistance coefficient $\zeta = 1.6$ from the figures 4.2.3 and 4.2.4
3. Calculation of the resistance coefficient: $\zeta_b = \zeta \frac{\alpha}{180^\circ} = 0.8$
4. Calculation of pressure loss: $p = \left(\lambda \frac{l_f}{d_i} + \zeta_b \right) \cdot \frac{\rho}{2} c^2 = 1743 \text{ Pascal}$

The interaction of the flowing medium with the hose corrugations can cause the annularly corrugated hose to resonate in an axial direction. These vibrations are audible and critical if a natural frequency of the hose is excited by an unfavourable combination of circumstances of flow velocity, hose length and elasticity. This is particularly likely with long and thin hoses with flow velocities far below the critical value in DIN EN ISO 10380 of 5 m/s.

4.2 Pressure loss and flow-induced vibrations

Although the vibration amplitudes are only a few μm per corrugation, such a vibration load can also cause the hose to fail due to the high frequencies and the associated large load cycles. The reason for the failure is generally a fatigue fracture on the outer crest.

4.3 Absorption of elevation movements

The formulas, described in chapters 4.3 to 4.6 for calculating the hose length required for the absorption of movements, each refer to the corresponding installation diagrams. They must reflect the installation and the movements exactly. If the installation diagram varies slightly from the actual installation, e.g. opposite direction of movement at the 90° bend, the calculation can usually be corrected easily, for example by interchanging the start and end point of the calculation.

U-bend configuration

Metal hose assemblies are best installed in the U-bend configuration to absorb larger elevation movements. Vertical (figures 4.3.1 and 4.3.2) and/or horizontal movements (fig. 4.3.3) can be absorbed at the level of the U-bend configuration. Movements vertical to the level of the U-bend configuration are not permitted. The resulting torsion would lead to a quick failure of the hose assembly at the clip positions. The hose assembly should preferably be installed vertically, as horizontal installation in most cases requires bracing to prevent sagging. Depending on the installation form, the required nominal length is calculated with one of the equations 4.3.1, 4.3.4 or 4.3.7. An extension in length compared with the standard DIN EN ISO 10380 to reduce the bending stress at the connection fittings has already been taken into account. The fixed side of the hose assembly bend should be in the middle of the elevation movement. A longer length of hose assembly should be selected for asymmetrical installation. The load cycles endured are dependent on the direction of movement, the bending radius and the operating pressure of the hose assembly. With an elevation movement parallel to the sides of the U-bend configuration, the HYDRA hose assemblies, with the nominal bending radii ($r = r_N$) and nominal pressures listed in table 4.1.1, achieve 10000 alternations of load, in accordance with DIN EN ISO 10380. The installation of a U-bend configuration is not suitable for high-frequency loads.

4.3 Absorption of elevation movements

Movement parallel to the flanks of the U-bend configuration

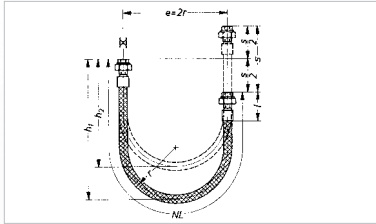

Fig. 4.3.1 Vertical absorption of movements in the vertical U-bend configuration

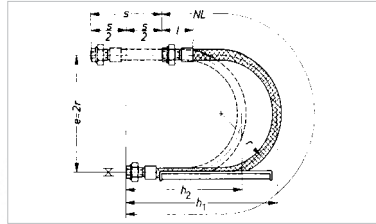

Fig. 4.3.2 Horizontal absorption of movements in horizontal U-bend configuration

Nominal length of hose: (4.3.1)

$$NL = 4 \cdot r + \frac{s}{2} + 2 \cdot l$$

Maximum height of U-bend configuration: (4.3.2)

$$h_1 = \left(3 - \frac{\pi}{2}\right) \cdot r + \frac{s}{2} + l = 1.43 \cdot r + \frac{s}{2} + l$$

Minimum height of U-bend configuration: (4.3.3)

$$h_2 = \left(3 - \frac{\pi}{2}\right) \cdot r + l = 1.43 \cdot r + l$$

4.3 Absorption of elevation movements

Movement perpendicular to the sides of the U-bend configuration

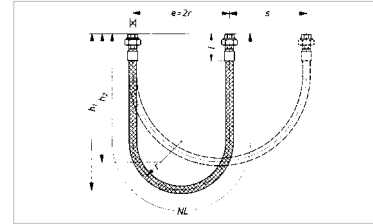

Fig. 4.3.3 Horizontal absorption of movements in vertical U-bend configuration

Nominal length of hose: (4.3.4)

$$NL = 4 \cdot r + \frac{\pi}{2} \cdot s + 2 \cdot l = 4 \cdot r + 1.57 \cdot s + 2 \cdot l$$

Maximum height of the U-bend configuration: (4.3.5)

$$h_1 = \left(3 - \frac{\pi}{2}\right) \cdot r + \frac{\pi}{2} \cdot s + l = 1.43 \cdot r + 0.785 \cdot s + l$$

Minimum height of U-bend configuration: (4.3.6)

$$h_2 = \left(3 - \frac{\pi}{2}\right) \cdot r + \frac{s}{2} + l = 1.43 \cdot r + 0.5 \cdot s + l$$

4.3 Absorption of elevation movements

Combined movement

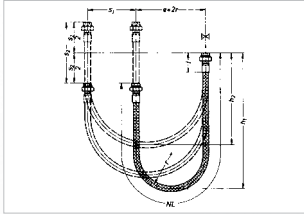

Fig. 4.3.4 Horizontal and vertical absorption of movements in vertical U-bend configuration

Nominal length of hose: (4.3.7)

$$NL = 4 \cdot r + \frac{\pi}{2} \cdot s_1 + \frac{s_2}{2} + 2 \cdot l = 4 \cdot r + 1.57 \cdot s_1 + 0.5 \cdot s_2 + 2 \cdot l$$

Maximum height of U-bend: (4.3.8)

$$h_1 = \left(3 - \frac{\pi}{2}\right) \cdot r + \frac{\pi}{4} \cdot s_1 + \frac{s_2}{2} + l = 1.43 \cdot r + 0.785 \cdot s_1 + 0.5 \cdot s_2 + l$$

Minimum height of the U-bend: (4.3.9)

$$h_2 = \left(3 - \frac{\pi}{2}\right) \cdot r + \frac{s_1}{2} + l = 1.43 \cdot r + 0.5 \cdot s_1 + l$$

The following example shows the use of the equations 4.3.1 to 4.3.9:

A corrugated hose of type RS 331 L12, DN 25, with a double-sided screw connection and conical seal of the type QB02S, is to be used for horizontal absorption of movements in a vertical U-bend configuration. The nominal length of the hose assembly is demanded:

The dimensions are:	$NL = 4 \cdot r + \frac{s}{2} + 2 \cdot l$
Bending radius: $r = 190 \text{ mm}$,	
Total stroke: $s = 320 \text{ mm}$,	$NL =$
Length of the connectors: $l = 88 \text{ mm}$	$4 \cdot 190 \text{ mm} + 0.5 \cdot 320 \text{ mm} + 2 \cdot 88 \text{ mm}$

The nominal length is determined according to Gl. 4.3.1: $NL = 1096 \text{ mm} \approx 1100 \text{ mm}$

4.4 Absorption of thermal expansion

Metal hoses can be used to compensate for thermal expansion. The selected form of installation depends on the size of the thermal expansion to be absorbed and on the space available at the place of installation. Preferred installation positions are the installation in the 90° bend shown in the figures 4.4.2 and described in 4.4.3, with restrictions also the lateral installation shown in figure 4.4.1. Due to the comparatively infrequent occurrence of thermal expansion, the 180° bend (U-bend configuration) is rarely used here.

Irrespective of the installation form, the fixed points and pipe guides should be attached directly to the hose line ends. With the compensation for thermal expansion, a service life of 1000 load cycles (20 years operation, weekly switching on and off of the plant) can generally be assumed. The installation forms shown here are not suitable for a highly frequent load.

Lateral expansion compensation

Metal hose assemblies can absorb smaller expansions at right angles to their axis. For reasons of symmetry, the hose assembly should be pre-stressed by half of the occurring expansion ($\frac{1}{2} s$).

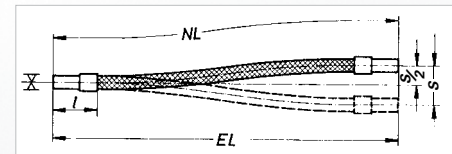

Fig. 4.4.1 Lateral absorption of movements using a hose assembly

The length of hose assemblies must be correctly measured. Too short a nominal length would lead to excessive tensile forces in the end positions of the movement and thereby reduce the service life of a hose assembly. The nominal length can be calculated according to the following formulas:

$$NL = \sqrt{(10 \cdot r_N \cdot s)} + 2 \cdot l \quad (4.4.1 \text{ a})$$

$$NL = 3 \cdot s + 2 \cdot l \quad (4.4.1 \text{ b})$$

4.4 Absorption of thermal expansion

The larger value is to be used. The value from table 4.1.1 or from chapter 6.3 is to be used here for the nominal bending radius r_N . In order to limit the tensile load in the end positions, the installation length of the hose assembly must be approx. 0.5% shorter than the nominal length:

$$EL \approx 0.995 \cdot NL \quad (4.4.2)$$

Too short an installation length is harmful as the wire netting can lift up from the middle of the hose. This can lead to local buckling or reduction of the pressure resistance of the hose assembly.

HYDRA metal hose assemblies (up to DN 100) can be installed laterally with a small movement frequency for an absorption of alternating movements up to

$$\max. \frac{s}{2} = 100 \text{ mm.}$$

Absorption of expansion in 90° bend

Even in piping, the installation of the hose assembly involves practical use of 90° angular offsets, such as corners or floors. The expansion direction and hose bend must be on one level to avoid torsional stress. With one-sided expansion reception, the pipe to be compensated should be run in the direction of the axis so that there is no sideways movement. A (light) fixed point is to be allocated to the conveying pipeline immediately at the end of the hose assembly. If expansion is to be absorbed from two directions, pipe guides have to be attached to both hose assembly ends to guarantee that the expansions to be absorbed run at right angles to each other.

For reasons of symmetry, the hose assembly should be pre-stressed with half of the expansion to be absorbed ($\frac{1}{2} s$).

The determination of the nominal length of the hose assembly for installation in the 90° bend requires the bending angle α to be identified first. The linear simplified equation for that is

$$\alpha = \arccos \left(1 - \frac{s}{2r} \right) \quad (4.4.3)$$

4.4 Absorption of thermal expansion

The actual angles α are somewhat smaller and can be read as a function of s/r in the table 4.4.1. The bending angle must not exceed 60° with one-sided expansion absorption and 45° with double-sided expansion absorption. If these critical bending angles are reached, the bending radius has to be increased and the calculation repeated.

One-sided expansion absorption in 90° bend

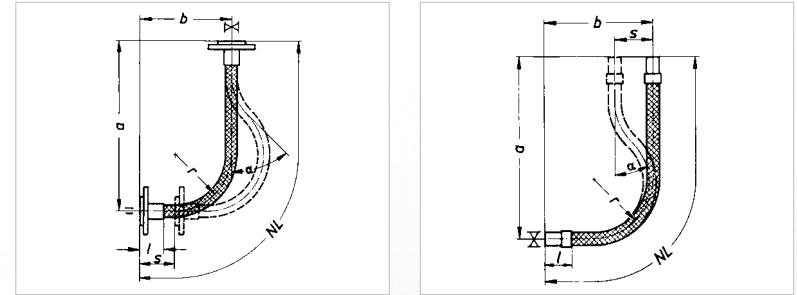

Fig. 4.4.2 One-sided absorption of movements using a hose assembly in the 90° bend

With the bending angle α , the one-sided expansion reception shown in fig. 4.4.2. produces the nominal length:

$$NL = 2 \cdot r \cdot \alpha + \frac{\pi}{2} \cdot r + 2 \cdot l = 0.035 \cdot r \cdot \alpha [^\circ] + 1.57 \cdot r + 2 \cdot l \quad (4.4.4)$$

and the installation dimensions:

$$a = r \cdot (1 + 2 \cdot \sin \alpha) + l \quad (4.4.5)$$

$$b = r \cdot (1 + 2 \cdot \alpha - \sin \alpha) + l = r \cdot (1 + 0.035 \cdot \alpha [^\circ] - 2 \cdot \sin \alpha) + l \quad (4.4.6)$$

4.4 Absorption of thermal expansion

Two-sided expansion absorption in 90° bend

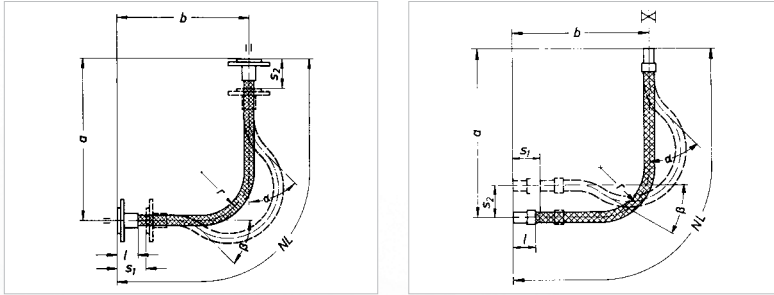

Fig. 4.4.3 Two-sided absorption of movements using a hose assembly in the 90° bend

The double-sided movement absorption (fig. 4.4.3) applies in the same way:

$$NL = 2 \cdot r \cdot (\alpha + \beta) + \frac{\pi}{2} \cdot r + 2 \cdot l = 0.035 \cdot r \cdot (\alpha [^\circ] + \beta [^\circ]) + 1.57 \cdot r + 2 \cdot l \quad (4.4.7)$$

$$a = r \cdot (1 + 2 \cdot \sin \alpha + 2 \cdot \beta - 2 \cdot \sin \beta) + l = r \cdot (1 + 2 \cdot \sin \alpha + 0.035 \cdot \beta [^\circ] - 2 \cdot \sin \beta) + l \quad (4.4.8)$$

$$b = r \cdot (1 + 2 \cdot \sin \beta + 2 \cdot \alpha - 2 \cdot \sin \alpha) + l = r \cdot (1 + 2 \cdot \sin \beta + 0.035 \cdot \alpha [^\circ] - 2 \cdot \sin \alpha) + l \quad (4.4.9)$$

4.4 Absorption of thermal expansion

0° - 30°

Bending angle Degree	Min.	Expansion compensation = $\frac{S}{r}$ Bending radius		
		0'	30'	60'
0		0.0000	0.0001	0.0003
1		0.0003	0.0007	0.0012
2		0.0012	0.0019	0.0028
3		0.0028	0.0038	0.0050
4		0.0050	0.0063	0.0078
5		0.0078	0.0095	0.0113
6		0.0113	0.0133	0.0155
7		0.0155	0.0179	0.0204
8		0.0204	0.0231	0.0259
9		0.0259	0.0289	0.0322
10		0.0322	0.0355	0.0391
11		0.0391	0.0428	0.0468
12		0.0468	0.0509	0.0551
13		0.0551	0.0596	0.0643
14		0.0643	0.0690	0.0741
15		0.0741	0.0793	0.0847
16		0.0847	0.0903	0.0961
17		0.0961	0.1020	0.1082
18		0.1082	0.1145	0.1211
19		0.1211	0.1278	0.1347
20		0.1347	0.1418	0.1491
21		0.1491	0.1567	0.1644
22		0.1644	0.1723	0.1804
23		0.1804	0.1887	0.1972
24		0.1972	0.2059	0.2148
25		0.2148	0.2239	0.2332
26		0.2332	0.2428	0.2525
27		0.2525	0.2624	0.2725
28		0.2725	0.2829	0.2934
29		0.2934	0.3042	0.3151

30° - 60°

Bending angle Degree	Min.	Expansion compensation = $\frac{S}{r}$ Bending radius		
		0'	30'	60'
30		0.3151	0.3263	0.3377
31		0.3377	0.3493	0.3611
32		0.3611	0.3731	0.3853
33		0.3853	0.3977	0.4104
34		0.4104	0.4232	0.4363
35		0.4363	0.4495	0.4630
36		0.4630	0.4767	0.4906
37		0.4906	0.5048	0.5191
38		0.5191	0.5337	0.5484
39		0.5484	0.5634	0.5786
40		0.5786	0.5940	0.6096
41		0.6096	0.6255	0.6415
42		0.6415	0.6578	0.6743
43		0.6743	0.6910	0.7079
44		0.7079	0.7250	0.7424
45		0.7424	0.7599	0.7777
46		0.7777	0.7957	0.8139
47		0.8139	0.8323	0.8510
48		0.8510	0.8698	0.8889
49		0.8889	0.9082	0.9277
50		0.9277	0.9474	0.9673
51		0.9673	0.9874	1.0078
52		1.0078	1.0284	1.0491
53		1.0491	1.0701	1.0914
54		1.0914	1.1128	1.1344
55		1.1344	1.1563	1.1783
56		1.1783	1.2006	1.2230
57		1.2230	1.2457	1.2686
58		1.2686	1.2918	1.3150
59		1.3150	1.3386	1.3623

Table 4.4.1 Determination of the bending angle for the calculation of 90° bends for absorbing expansion

4.4 Absorption of thermal expansion

Sample calculation

An annularly corrugated hose assembly, type RS 331 L12, DN 25 made of stainless steel with welding ends, type UA12S, on both sides and made of steel pipe should be installed in the 90° bend and take up thermal expansion from two directions. The following are given:

Bending radius: $r = 190 \text{ mm}$,
 Horizontal elevation: $s_1 = 78 \text{ mm}$,
 Vertical elevation: $s_2 = 48 \text{ mm}$,
 Length of welding ends: $l = 83 \text{ mm}$.

The bending angles can be seen in the table 4.4.1 with the values $s_1/r = 0.411$ and $s_2/r = 0.252$. The calculation according to Gl. 4.4.3 would lead to the somewhat greater angles given in brackets.

Vertical bending angle: $\alpha = 34^\circ (37^\circ)$
 Horizontal bending angle: $\beta = 27^\circ (29^\circ)$

The nominal length arises from Gl. 4.4.7:

$$NL = 0.035 \frac{\text{rad}}{^\circ} \cdot 190 \text{ mm} \cdot (34^\circ + 27^\circ) + 1.57 \cdot 190 \text{ mm} + 2 \cdot 83 \text{ mm} = 870 \text{ mm}$$

The installation dimensions from the Gl. 4.4.8 and 4.4.9:

$$a = 190 \text{ mm} \cdot \left(1 + 2 \sin 34^\circ + 0.035 \frac{\text{rad}}{^\circ} \cdot 27^\circ - 2 \cdot \sin 27^\circ\right) + 83 \text{ mm} = 492 \text{ mm}$$

$$b = 190 \text{ mm} \cdot \left(1 + 2 \sin 27^\circ + 0.035 \frac{\text{rad}}{^\circ} \cdot 34^\circ - 2 \cdot \sin 34^\circ\right) + 83 \text{ mm} = 459 \text{ mm}$$

4.5 Compensation of mounting tolerances and pipework offset

Metal hoses can be used for the static correction of mounting tolerances. In the case of parallel pipework offset, the S-shaped installation shown in fig. 4.5.1 is possible. The nominal and installation length of the hose assembly can be calculated from the size of the axis offset a , the permitted minimum bending radius r and the bending angle α .

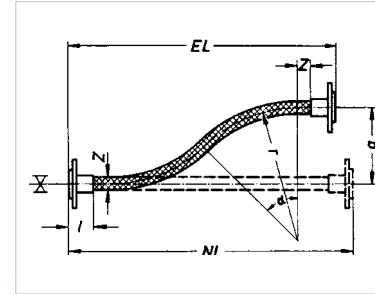

Fig. 4.5.1 S-shaped hose assembly installation for static correction of a parallel pipe misalignment

$$\alpha = \arccos \left(1 - \frac{a}{2 \cdot r}\right) \quad (4.5.1)$$

$$NL = 2 \cdot (r \cdot \alpha + l + z) = 0.035 \cdot r \cdot \alpha [^\circ] + 2 \cdot (l+z) \quad (4.5.2)$$

$$EL = 2 \cdot (r \cdot \sin \alpha + l + z) \quad (4.5.3)$$

Bending angles $> 60^\circ$ must not be exceeded. For bending angles $> 45^\circ$, the following formulas apply to braided hoses:

$$NL = 2.680 \cdot a + 2(l+z) \quad (4.5.4)$$

and

$$EL = 2.414 \cdot a + 2(l+z) \quad (4.5.5)$$

4.5 Compensation of mounting tolerances and pipework offset

However, in order to relieve the stress on the hose, it is wise to avoid bending angles > 45° or, alternatively, to use hose assemblies with a larger bending radius and greater length.

The neutral hose end z reduces the load of the hose on the interface to the end parts. When installing the hose assembly, it is therefore important to ensure that the hose assembly does not get bent directly behind the connection fittings. With larger hose dimensions or large offsets, it is helpful to bend the hose assembly into the required shape before mounting. The length of the neutral hose end (z) should be at least as large as the outside diameter of the hose assembly.

The Gl. 4.5.2 and 4.5.3 lead to very short hose lengths. The hose assemblies are therefore not suitable for absorbing recurring movements. If vibrations or movements have to be absorbed during operation, the installation forms specified in chap. 4.3, 4.4 or 4.6 are to be used.

4.6 Absorption of vibrations

Besides the HYDRA vibration absorbers described in chap. 3.1, standard hose assemblies mounted in a 90° bend (DN 10-100) or using a corner piece (DN 125-200) can be used to absorb vibrations and to dampen the resulting noise. A fixed point is to be positioned directly behind the hose. Fig. 4.6.1 shows the possible installation forms. Hoses mounted in the 90° bend can absorb vibrations in any direction in the hose level.

The installation dimensions for standard hoses for damping vibrations can be found in table 4.6.1. They are determined empirically and are selected in such a way that amplitudes of ± 1 mm in continuous operation and amplitudes of ± 5 mm for DN ≤ 16 as well as ± 10 mm for DN > 16 at switch on/off can be tolerated. Due to the small deflections, the radii for the 90° bend listed in table 4.6.1 are significantly smaller than the nominal radii for absorbing movement listed in chapter 6.3.

4.6 Absorption of vibrations

The relation between radius r, nominal length l and installation dimension a for the 90°-elbow is:

$$NL = 2.3 \cdot r + 2 \cdot l \quad (4.6.1) \quad \text{and} \quad a = 1.365 \cdot r + l \quad (4.6.2)$$

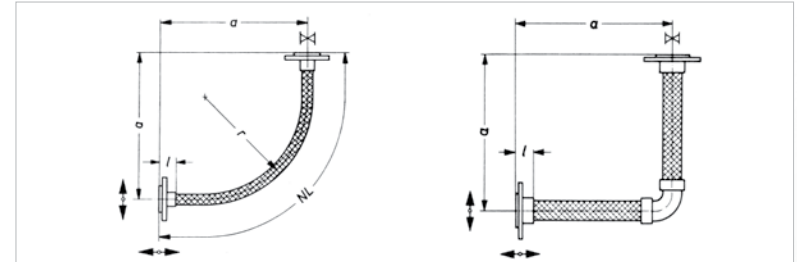

Fig. 4.6.1 Metal hoses for absorption of vibrations: annularly-corrugated hose in 90° bend (left), annularly-corrugated hose at 90° angle (right)

	Installation mode 90° bend										Installation mode 90° angle with corner piece			
	RS 331										RS 330			
DN	10	12	16	20	25	32	40	50	65	80	100	125	150	200
r	80	90	110	150	170	200	240	280	300	350	400	-	-	-
a	155	170	200	255	285	340	400	460	490	575	635	700	800	-
l _{max}	50	50	50	50	55	70	75	80	80	95	95	120	130	-
NL	280	300	350	450	500	600	700	800	850	1000	1100	-	-	-
	RS 531					RS 430					RS 430			
	r	140	160	180	230	260	290	310	360	400	470	580	-	-
a	255	285	315	375	405	460	520	580	635	750	875	850	1000	1150
l _{max}	55	60	60	60	60	70	80	85	90	95	95	120	130	140
NL	450	500	550	650	700	800	900	1000	1100	1300	1500	-	-	-

Table 4.6.1 Installation dimensions for metal hoses for the absorption of vibrations

If the leak tightness requirements are minimal, then the stripwound hoses are also well suited to absorbing vibrations. They have very good damping qualities on account of the abrasion between the individual threads.

4.7 Installation and assembly instructions

With appropriate installation and proper use, hose assemblies are durable, robust and nearly maintenance-free products. Dynamic loads such as movements and vibrations but also pulsations and impacts can reduce the service life. Hose lines must regularly undergo visual inspection by the operating company. Particular attention is to be paid to damage, e.g. buckling, torn braiding and corrosion as well as soiling.

The following information is intended to help avoid installation faults and damage to the hose assemblies through improper use.

Handling and installation (figures 4.7.1 to 4.7.6)

In general, the manufacturer performs a pressure and leak test.

Check hose lines for possible damage, e.g. in transport, before installation. Do not install defective hose assemblies.

Fixed hose lines, in which connecting and decoupling is not part of standard operation, should undergo a pressure test before commissioning. This also applies for recommissioning of these hose lines after installation and extension or after plant conversion. In every case, the safety regulations applicable for the particular application must be observed.

Do not exceed the permissible values for operating pressure, test pressure and operating temperature. Only apply the test pressure at room temperature.

Safe operation is exclusively based on the conditions agreed in the order.

The insulation may not restrict the flexibility of the hose assembly. Do not use insulation material with corrosive components.

Hose assemblies must be protected against heavy soiling.

4.7 Installation and assembly instructions

Hose assemblies are to be subjected to a regular visual inspection by the operator. Particular attention is to be paid to damage, e.g. buckling or torn braiding, soiling and corrosion. Hose lines with visible defects are not allowed to be operated further.

Protect hose assemblies against mechanical damage. Unroll hose assemblies when setting up.

Hose assemblies may not be pulled over the floor or over sharp objects, as pulling on one end of a hose ring can lead to the permissible minimum bending radius being underrun and/or the hose being subjected to torsion (fig. 4.7.1).

If external mechanical loads, such as frequent pulling to the ground, cannot be avoided then the hose assembly should be protected against damage, either by an external round wire coil or by a protective hose, depending on degree of load (fig. 4.7.2).

Hose assemblies are to be mounted in such a way that they do not come into contact with each other or with surrounding objects during operation (fig. 4.7.3).

The permissible minimum bending radius must not be underrun. Avoid a localised underrun of the permissible minimum bending radius by the use of rollers or fixed pipe bends (fig. 4.7.4).

Avoid torsion as it can cause early breakdown.

To mount hose assemblies in a torsion-free manner, first attach the pipeline firmly on one side and fix the other side loosely. After that, carry out 2 or 3 movement cycles at zero pressure so that the hose assembly can be aligned free of torsion. The second side of the hose assembly can then be pulled tight.

4.7 Installation and assembly instructions

Counter flanges must then be uniformly tightened cross-wise. The bolt holes must exactly be aligned. A loose flange can be used on one side (fig. 4.7.5 left). A second spanner must be held against rotatable threaded connections (fig. 4.7.5 right).

With welding or brazing work, the hose assemblies must be protected against weld or flux spatter. Flux residue has to be removed. Electrical short circuit through welding electrodes or ground cable must be avoided without fail, since this can cause irreparable damage to the hose. In the case of hose assemblies with internal braze ends, the hose assembly end to be brazed should be protected against excessive heating with a wet strip or with heat insulating paste. Keep the burner away from the hose assembly (fig. 4.7.6).

Attach fixed points or pipe guides directly to the hose assembly ends.



Fig. 4.7.1 Proper (left) and incorrect handling (right) of hose assemblies

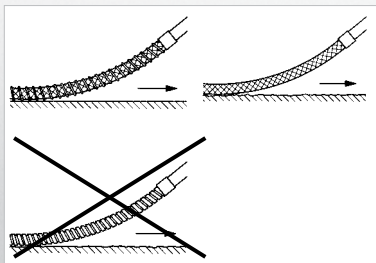

Fig. 4.7.2 External protection via round wire coil or protective hose for hose assemblies (at top) subject to heavy mechanical loads and non-approved use of an unprotected hose assembly (at bottom).

4.7 Installation and assembly instructions

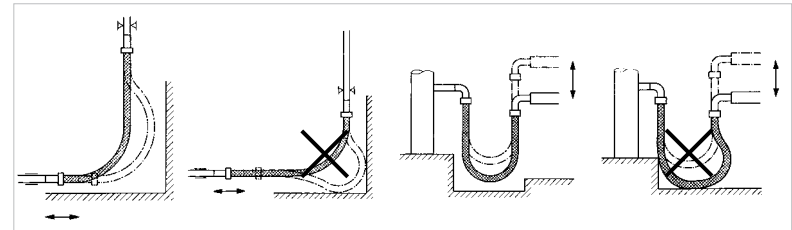

Fig. 4.7.3 Collision-free (left sub-images) as well as incorrect installation of hose assemblies (right sub-images)

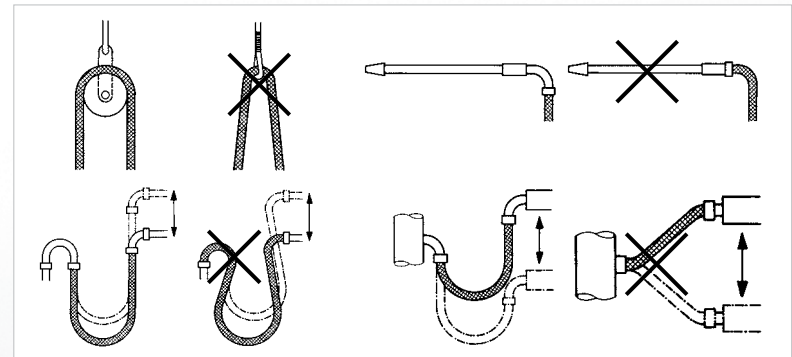

Fig. 4.7.4 Avoidance of smaller bending radii using rollers or rigid pipe bends (left sub-images) compared with incorrect installation (right sub-images)

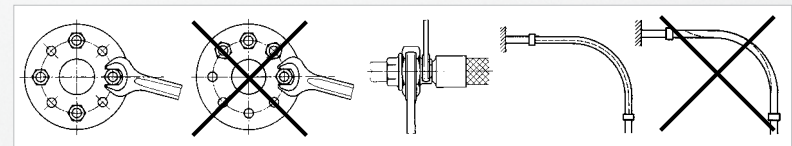

Fig. 4.7.5 Torsion-free (left sub-images) and incorrect mounting (right sub-images) of the connecting flange

4.7 Installation and assembly instructions

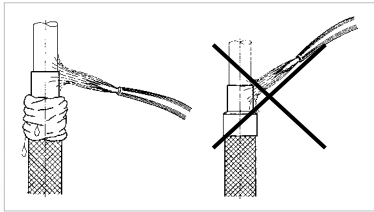

Fig. 4.7.6 correct (left) and incorrect brazing (right) on a hose assembly

Absorption of expansions and/or movements (figures 4.7.7 to 4.7.10)

Axial absorption of expansions is not permitted. Large movements must be absorbed by the 180° bend. Installation of a hose assembly in the 90° bend or a lateral absorption of movement (fig. 4.7.7) can absorb thermal expansions (small movements).

The hose axis and motion direction must be at the same level to avoid torsion (fig. 4.7.8).

The hose assembly must be long enough to avoid underrunning the permissible minimum bending radius at the fixing points (fig. 4.7.9).

Hose assemblies for lateral expansion compensation must be installed at right angles to the direction of expansion and be pre-stressed to half of the occurring expansion (fig. 4.7.10). The hose assemblies may not be too short, to avoid tensile loads in the end positions. With larger expansions/movements, a hose assembly must be installed in the 90° or in the 180° bend.

4.7 Installation and assembly instructions

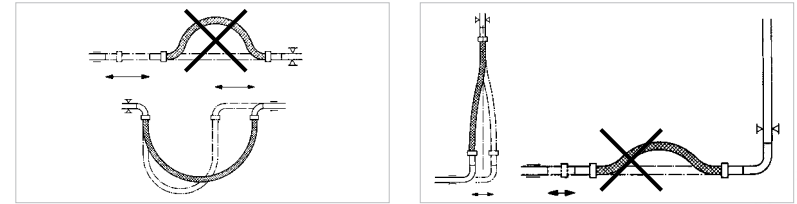

Fig. 4.7.7 Correct absorption of movement in the U-bend configuration or lateral (lower and left sub-images) and impermissible axial absorption of movement (upper and right sub-images)

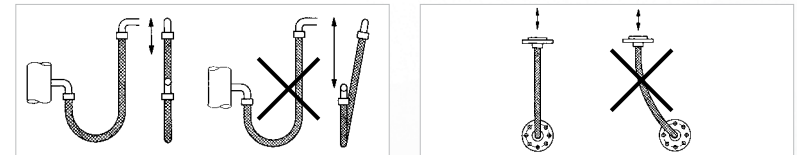

Fig. 4.7.8 Movement of hose assembly without (left sub-images) and with torsional load (right sub-images)

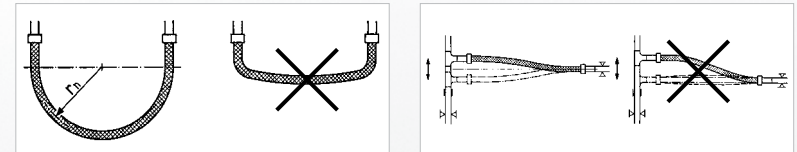

Fig. 4.7.9 Sufficient length (left) and too short (right) hose assembly in 180° bend

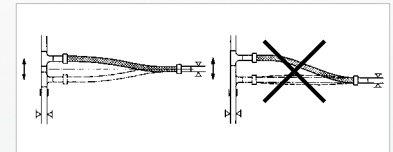

Fig. 4.7.10 Lateral expansion compensation with correctly prestressed (left) and wrongly installed hose assembly (right)

4.7 Installation and assembly instructions

Correction of misalignment (fig 4.7.11)

Hose assemblies for the correction of misalignments are to be installed stress-free and are to be fitted with sufficient large neutral hose ends. The hose assembly must not be folded over or stretched.

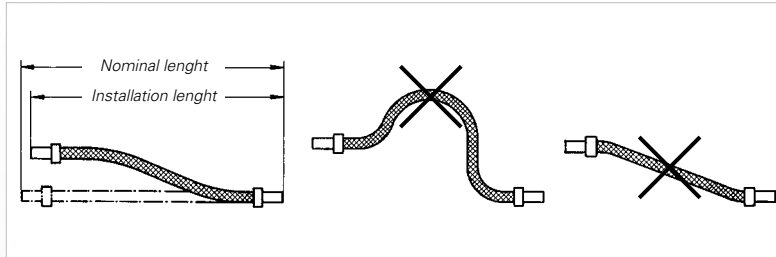

Fig. 4.7.11 Correct (left), too big (middle) and too small nominal length (right) of a hose assembly for correcting a misalignment.

Absorption of vibrations (figures 4.7.12 and 7.4.13)

The hose assembly should be attached as close as possible to the vibration aggregate.

The vibration direction must be perpendicular to the hose axis (HYDRA vibration absorber) or on the level of the 90° bend or angle formed by the hose assembly (fig. 4.7.12).

Select the length and installation dimensions of the hose assembly in such a way that the hose assembly can be installed stress-free and in a way that creates a 90° bend or angle (fig. 4.7.13).

For the hose assembly to be able to absorb vibrations, a fixed point must be provided on the conveying pipeline. The hose assembly must not be subjected to supporting the pipe weight.

4.7 Installation and assembly instructions

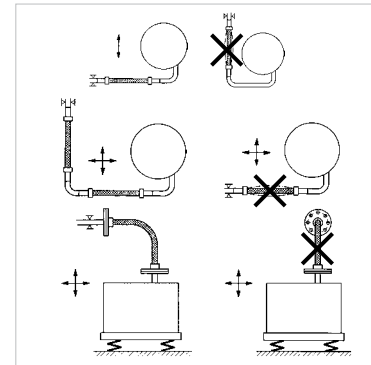

Fig. 4.7.12 Correct positioning (left sub-image) and incorrect installation (right sub-images) of hose assemblies for the absorption of vibrations

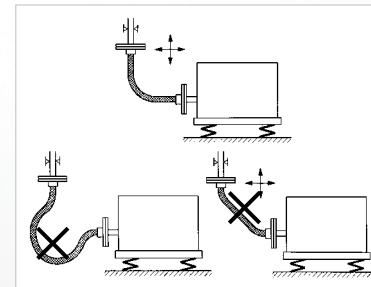
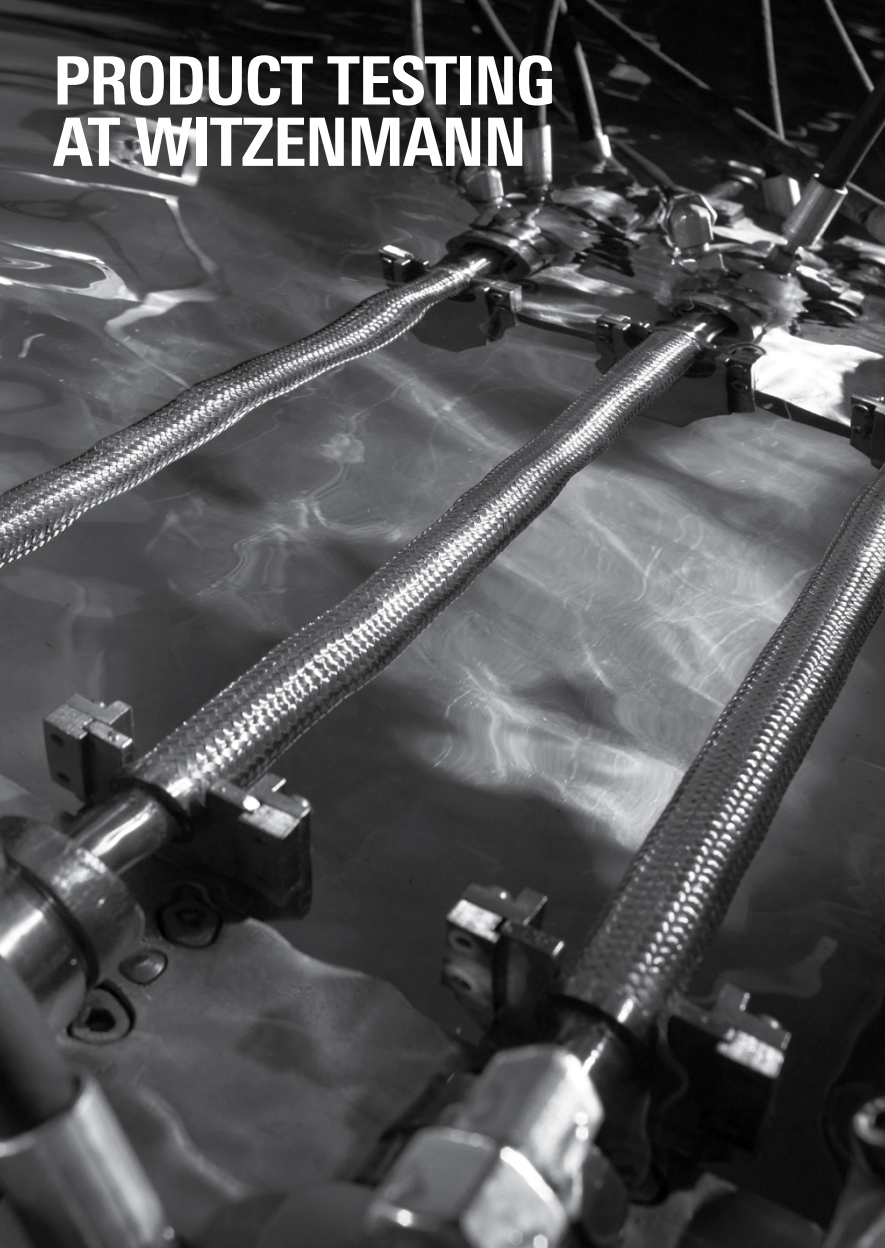

Fig. 4.7.13 Hose measured correctly (top), too long (bottom left) and too short (bottom right) to absorb vibrations

PRODUCT TESTING AT WITZENMANN



5. Product testing at Witzemann

5.1	Testing and analysis options	110
5.2	Production-related tests on metal hoses	112
5.3	Type approvals and destructive tests on metal hoses	114

5.1 Overview of testing and analysis options

Witzenmann has a comprehensive range of test and analysis options for determining and checking product characteristics on an experimental basis. The test field includes, among other things:

- Multiple test stands to represent complex movements,
- Electro-dynamic shakers,
- One pressure impulse test stand,
- Test stands for proof pressure testing as well as
- Leakage test stands

Witzenmann also has a materials' laboratory for mechanical, technological and metallographic tests, as well as for welding process and approval tests.

The laboratory equipment includes the following:

- Tension and impact-bending test machines,
- Comprehensive preparation technology for metallographic grinding,
- Scanning electronic microscope with integrated X-ray spectral analysis,
- A rinsing cabinet,
- Corrosion test stands, as well as
- An X-ray, radio graphen facilities

The following procedures may be carried out or produced:

- Testing of mechanical characteristics as well as corrosion resistance for hose and connecting piece materials at room temperature or at high temperatures,
- Micro sections evaluation of the geometry of bellows and weld seams,
- Micro sections to analyse structure, determine grain size and delta ferrite,
- Hardness measurements,
- Analysis of material composition and the local element distribution,
- Fracture surface and inclusion analyses and
- Cleanliness analysis

5.1 Overview of testing and analysis options

Other tasks of the metallographic laboratory include assessments of metal hoses which failed in the field or during testing, as well as an analysis of the root cause of the damage.

The Witzenmann material laboratory is recognised by the main approval and classification companies as a production-independent testing authority for destructive and non-destructive material testing, and is also approved to issue test certificates.



Fig. 5.1.1 Surfaces (top), structure (middle) and purity analysis (bottom) on precision strip made of material 1.4571.

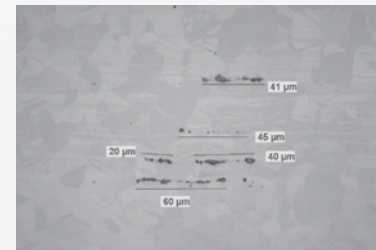
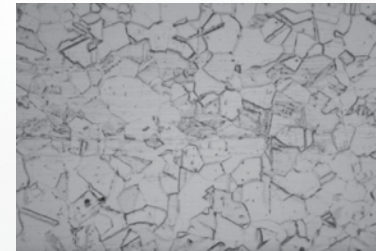

5.2 Production-related tests on metal hoses

Leak test

The Witzemann standard leak test is carried out on hoses with nitrogen under water and at room temperature. The minimum period for hoses without braid is 30 seconds and 60 seconds with braid. No bubbles may occur. This test detects leakage rates of greater than approximately 10^{-4} mbar l / sec.

The helium leakage test is used as standard for higher leak tightness requirements. The vacuum method of the helium leakage test is a high-resolution leak test. The component to be tested is evacuated and the surface away from the vacuum is exposed to a helium atmosphere. Helium atoms penetrating the vacuum are identified using a mass spectrometer. The sensitivity of the measurement increases with the duration of the test period. The detection limit is approx. 10^{-10} mbar l / s.

Leakage rates of 10^{-6} mbar l / s can be identified well in practice. This corresponds to a flow volume of approx. 0.03 l / year under normal conditions. Table 5.2.1 provides an overview of leak sizes and associated volume flows under normal conditions for other leak rates ($\Delta P = 1$ bar, 20°C).

Leakage rate	Leak diameter	Volume flow	Volume flow	Remark/example
		(under normal conditions)		
[mbar l / s]	[μm]	[l / s]	[l / year]	
10^{-10}	0.001	10^{-13}	3.15×10^{-6}	Verification limit
10^{-8}	0.01	10^{-11}	3.15×10^{-4}	Highly vacuum-tight*
10^{-7}	0.03	10^{-10}	3.15×10^{-3}	Gas-tight*
10^{-6}	0.1	10^{-9}	0.032	-
10^{-5}	0.33	10^{-8}	0.315	-
10^{-4}	1	10^{-7}	3.15	Vapour-tight*
10^{-3}	3.3	10^{-6}	31.5	Watertight* an air bubble ($\varnothing 1$ mm) per sec.
10^0	100	10^{-3}	31500	Leaky water tap

Table 5.2.1 Leakage rates and associated volume flows for helium leakage test

*non-standard representation, no exact definition for a leakage rate

5.2 Production-related tests on metal hoses

Helium is also used for a suiting process for testing with special requests or on request.

Testing of weldseams

A continuous leak test is carried out on the longitudinal butt-welds for metal hoses before deformation.

X-ray analysis is only worthwhile in the area of connecting seams for hoses without braid.

The connecting seams in hose assemblies with and without braid can be subjected to a surface crack detection test according to the dye penetration process. The inspection occurs visibly; with the red-white method during daylight and, with the fluorescent method, under UV lighting.

5.3 Type approval and destructive tests on metal hoses

Pressure resistance testing

DIN EN ISO 10380 defines pressure resistance testing for metal hoses as the pressure lengthening and bursting tests. Both are usually carried out at room temperature with water as a test medium.

Load cycle testing

The proof of service life for metal hoses can only be issued as part of a test. Standard tests are the U-bend configuration test according to DIN EN ISO 10380 or alternating bending test with a defined bending radius, e.g. for gas hoses, according to EN 14800. Fig. 5.2.1 shows such an alternating bending test with templates for defining the bending radius. Alternatively, loads, similar those which occur in practice, can also be reproduced in the test. This requires significantly more complex test facilities.

Load cycle tests on hoses normally take place during the range of finite life, as rubbing wear and fatigue mean there is no real durability. For statistical reasons, load cycle testing should always be carried out on several test objects. The standard number of test objects at Witzenmann is 6 test objects per load level.

5.3 Type approval and destructive tests on metal hoses

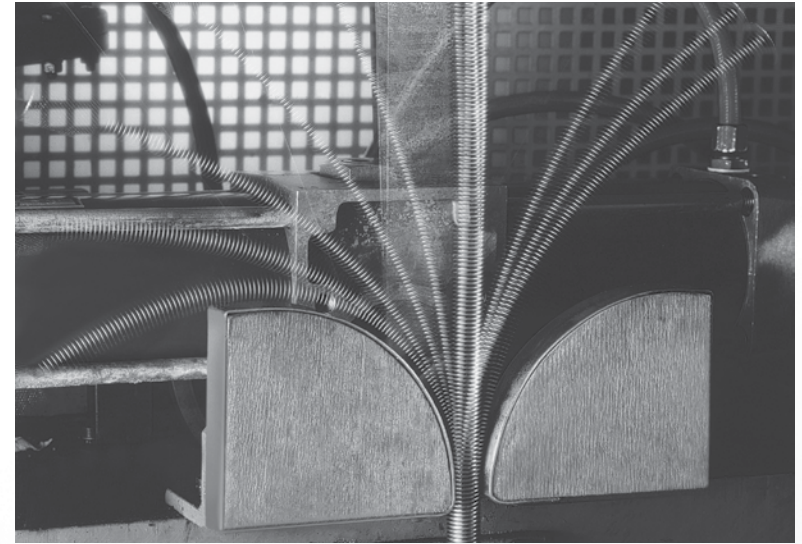

Fig. 5.3.1 Alternating bending test on a metal hose

Characterisation of components

Experiments may also be used to determine component characteristics, which are then confirmed with a test certificate. The following are possible for hoses:

- Measurement of geometry,
- Recording of pressure volume or pressure extension curves,
- Determination of natural frequencies as well as characterisation of dynamic transfer behaviour.



6. Technical tables

6.1	Hose selection from the manual	118
6.2	Hose selection with FLEXPORTE	123
6.3	HYDRA annularly corrugated hoses – goods sold by the metre	124
	- RS 330 / 331 – stainless steel annularly corrugated hoses	124
	- RS 321 – stainless steel annularly corrugated hoses	126
	- RS 341 – stainless steel annularly corrugated hoses	128
	- RS 531 – stainless steel annularly corrugated hoses	130
	- RS 430 – stainless steel annularly corrugated hoses	132
	- RZ 331 – bronze annularly corrugated hoses	134
	- RS 351 – semi-flexible annularly corrugated hoses	136
	- IX 331 – semi-flexible annularly corrugated hoses	137
	- ME 539 – semi-flexible helical corrugated hoses	138
6.4	Connection fittings	139
	- Connection fittings for HYDRA corrugated hose assemblies	140
	- Self-assembly connection fittings	174
6.5	HYDRA annularly corrugated hose assemblies	184
	- HYDRA double hose assemblies	184
	- HYDRA insulating hose	186
	- PTFE-lined HYDRA hose assemblies	187
	- HYDRA vibration absorber	188
	- HYDRA gas hose assemblies according to DIN 3384	190
	- Hose assemblies for presses	194
	- Hydriflex – hose assemblies for semi-flexible pipework	198
6.6	HYDRA stripwound hoses – fittings, hose assemblies	200
	- HYDRA protective hoses	202
	- Connection fittings for HYDRA – stripwound hoses	228
	- Air extraction, exhaust and conveying hoses	231
	- Flexible arms	250

6.1 Hose selection from the manual

The basic data for the selection of a hose from the technical tables is as follows

- The nominal diameter DN,
- The operating pressure PS,
- The operating temperature TS, as nec.
- The test pressure PT plus
- The motion to be absorbed.

Design based on nominal pressure

The key factor for designing on the basis of nominal pressure is usually the operating pressure, converted to a value at room temperature (PS/C_t). Should a high test pressure (PT) be specified separately, then this can also be the key factor.

$$PN \geq \max \left\{ \begin{array}{l} PS / C_t \\ PT / 1.5 \end{array} \right. \quad (6.1.1)$$

For some hose assemblies, test pressures greater than 1.5 PN are permissible on request. For temperatures TS > 20 °C, the pressure reduction factor

$$C_t = \frac{PS}{P_{RT}} = \frac{R_{P1.0}(TS)}{R_{P1.0}(20^\circ C)} \quad (6.1.2)$$

takes the reduction of the mechanical strength of hose and braid into account. Numerical values for C_t according to ISO 10380* are indicated in table 6.1.1. With differences between hose and braid materials, the reduction factor for the less solid material is always to be used.

Material	Temperature [°C]											
	20	50	100	150	200	250	300	350	400	450	500	550
1.4306*	1,00	0,89	0,72	0,64	0,58	0,54	0,50	0,48	0,46	0,44	0,43	0,43
1.4301*	1,00	0,90	0,73	0,66	0,60	0,55	0,51	0,49	0,48	0,46	0,46	0,46
1.4541*	1,00	0,93	0,83	0,78	0,74	0,70	0,66	0,64	0,62	0,60	0,59	0,58
1.4404/1.4435*	1,00	0,90	0,73	0,67	0,61	0,58	0,53	0,51	0,50	0,49	0,47	0,47
1.4571*	1,00	0,92	0,80	0,76	0,72	0,68	0,64	0,62	0,60	0,59	0,58	0,58
2.1020/2.1030	1,00	0,95	0,90	0,80	0,75	0,70	-	-	-	-	-	-

Table 6.1.1 Reduction factors for the pressure C_t

6.1 Hose selection from the manual

Pressure pulsations

The pressure surges or growing pulsating loads added to the static pressure can considerably reduce the service life of the hose. Their influence can be estimated on a mathematical basis at Witzemann on request. It depends on the braid, the size of the pulsating loads and their frequency. Such mathematical backup is recommended for pulsating loads Δp > 0.25 PN.

Selection of connectors

The possible connectors for use with the hose assembly are also listed in chapter 6.3. When making a selection, it is important to note that the maximum nominal pressure for the hose assembly is always determined by the smaller value of the permissible nominal pressure for hoses sold by the metre and connectors.

Certification according to DIN EN ISO 10380

The technical data for HYDRA metal hoses outlined in this manual comply with DIN EN ISO 10380. Hoses from the RS331/330 series are certified in accordance with DIN EN ISO 10380:2013 as hose assemblies without braiding and with single braiding respectively and the RS531/430 series are certified additionally as hose assemblies with double braiding. Fusion welding is certified as the process for connecting the hose and connectors. Other types of hoses can be certified by agreement.

6.1 Hose selection from the manual

Selection of hose type

The selected hose type must be capable of achieving the required nominal pressure. In order to simplify the selection of hoses, Table 6.1.2 lists the maximum permissible nominal pressures for braided goods sold by the metre for all the hose series listed in the manual. Often, several types of hoses can be used for a specified nominal pressure. The final choice focuses on the bending radius and mounting situation.

Hoses with a nominal pressure of PN > 250 are available on request.

For some hoses the permissible nominal pressure for static application is higher than the nominal pressure listed in Table 6.1.2 when the hose is moving. This is caused by the risk of a localised buckling of the hose. The statically permissible values only arise from the burst pressure and are - if deviating from the nominal pressure for dynamic applications - listed with the individual series.

Name of the hoses

The name of the hoses provides information on the annularly corrugated hose used, the braid and the nominal diameter. RS321 S00 DN32 for example stands for a tightly-corrugated annularly corrugated hose (RS321) with a nominal diameter of 32 (DN32) without connectors and without braid (S00).

RS531L22 DN10 indicates a hose assembly with a nominal diameter of 10 (DN10), consisting of an annularly corrugated with standard corrugation and increased wall thickness (RS531) with connectors and double braid (L22).

6.1 Hose selection from the manual

Nominal diameter	Max. nominal pressure PN according to DIN EN 10380 for braided goods sold by the metre					
	RS 331 / RS 330	RS 321	RS 341	RS 531	RS 430	RZ 331
4/5	100			200		
6	150	100	100	250		
8	125	100	100	250		60
10	100	80	65	225		45
12	75	50	65	200		35
15/16	65	50	65	200		32
20	40	40	40		100	30
25	65	40	50		100	30
32	25	20	25		80	30
40	40	20	40		65	25
50	30	16	25		65	28
65	25	16	25		50	
80	16	10	25		25	
100	10	4	16		16	
125	6				16	
150	6				16	
200					16	
250					10	
300					6	

Table 6.1.2 Maximum permissible nominal pressures according to DIN EN 10380 for braided goods sold by the metre, with dynamic application

6.1 Hose selection from the manual

Determination of nominal length

If the hose type and nominal diameter are defined, the permissible nominal bending radius for frequent movements can be found in table 6.1.3 or the tables in chapter 6.3. The hose models RS 321, RS 331 / RS 330, RS 531 and RZ 331 have nominal bending radii that are smaller or the same as the nominal bending radius for type 1 hoses according to DIN EN ISO 10380.

The nominal bending radii of the hose models RS 341 and RS 430 are to be allocated to the nominal diameters for type 1 or 2. The minimum length of the hose assembly is calculated from the nominal bending radius. According to the mounting situation and the size of the movement to be absorbed, the formulas indicated in chapters 4.3 to 4.6 are to be used.

Nominal diameter	Nominal bending radius for frequent movements r [mm]							
	DIN EN ISO 10380 type 1	RS 331 / RS 330	RS 321	RS 531	DIN EN ISO 10380 type 2	RS 341	RS 430	RZ 331
4/5	100	80		100	120			
6	110	80	70	110	140	110		
8	130	120	80	130	165	130		90
10	150	130	90	150	190	150		130
12	165	140	100	165	210	165		150
15/16	195	160	110	195	250	195		170
20	225	170	130		285	225	285	200
25	260	190	150		325	260	325	230
32	300	260	200		380	300	380	260
40	340	300	210		430	340	430	310
50	390	320	240		490	390	490	360
65	460	460	280		580	460	580	
80	660	660	400		800	660	800	
100	750	750	500		1000	750	1000	
125	1000	1000			1250		1250	
150	1250	1250			1550		800	
200	1600				2000		1100	
250	2000				2500		1350	
300	2400				3000		1600	

Table 6.1.3 Nominal bending radius for frequent movements

6.1 Hose selection from the manual

Length tolerance

The nominal length (NL) relates to the hose fitted with connection fittings and describes the total length of the hose. Unless otherwise agreed in the order, the following permissible variations in length are to be taken into account in checking the nominal length:

Nominal lengths in mm	Permissible deviations in length
Up to 500	+ 10 mm - 5 mm
Over 500 Up to 1000	+ 15 mm - 10 mm
Over 1000	+ 1.5% - 1.0%

Smaller length tolerances are possible but they have to be agreed when the order is placed.

Cleanliness

Mechanically corrugated hoses sold by the meter are produced up to DN 50 using oil and grease free processes. This and subsequent cleaning procedures also permit the use of HYDRA hose assemblies for applications with the highest cleanliness requirements, such as vacuum applications or applications involving oxygen and hydrogen.

6.2 Hose selection with FLEXPORTE

FLEXPORTE is a configuration software for flexible metallic elements. Accordingly, the current configuration rules allow the use of products in the standard production series, as and when required. In addition to metal hoses, the product range can also be used to configure metal bellows, expansion joints and pipe supports. When the operating conditions have been entered, the program offers a selection of suitable products along with all necessary information and drawings for direct further processing in the form of an inquiry or an order. The program is available online for immediate use at www.flexperte.de.

6.3 HYDRA® annularly corrugated hoses - goods sold by the metre

RS 330 / 331

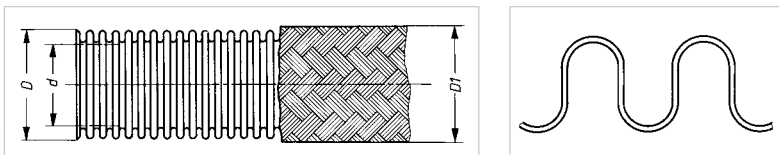

- Annularly corrugated hose made of butt-welded pipe, mechanically corrugated (DN 4 to DN 100) or hydraulically shaped (from DN 125)
- Wall thickness: standard
- Corrugation: standard
- Versions:
 - RS 330 / RS 331 S00 without braid
 - RS 330 / RS 331 S12 with single braid
- Maximum production length:
 - DN 4: 30 m
 - DN 6 - 50: 100 m
 - DN 65 - 100: 20 m
 - DN 125 - 150: 10 m
 Longer hose assemblies available on request
- Standard materials:
 - Annularly corrugated hose 1.4404 or 1.4541
 - braid 1.4301
 Other materials are available on request.

6.3 HYDRA® annularly corrugated hoses - goods sold by the metre

DN	Type	Inside diameter	Outside diameter	Permissible deviation	Minimum bending radius	Nominal bending radius	Permissible static operating pressure at 20 °C SF4	Nominal pressure	Weight approx.
					Single bend	Frequent movements		ISO 10380 SF4	
-	-	d	D,D1	d,D,D1	r _{min}	r _n	P _{perm}	PN	-
-	-	mm	mm	mm	mm	mm	bar	-	kg/m
4	RS331S00	4.3	7.1	± 0.1	15	80	40	-	0.06
	RS331S12				25				100
6	RS331S00	6.2	9.7	± 0.2	15	80	28	-	0.08
	RS331S12				25				150
8	RS331S00	8.3	12.3	± 0.2	16	120	20	-	0.10
	RS331S12				32				125
10	RS331S00	10.2	14.3	± 0.2	18	130	16	-	0.11
	RS331S12				38				100
12	RS331S00	12.2	16.8	± 0.2	20	140	10	-	0.12
	RS331S12				45				75
16	RS331S00	16.2	21.7	± 0.3	28	160	8	-	0.19
	RS331S12				58				65
20	RS331S00	20.2	26.7	± 0.3	32	170	5	-	0.27
	RS331S12				70				40
25	RS331S00	25.5	32.2	± 0.3	40	190	4	-	0.38
	RS331S12				85				65
32	RS331S00	34.2	41.0	± 0.4	50	260	2.5	-	0.49
	RS331S12				105				25
40	RS331S00	40.1	49.7	± 0.4	60	300	2.5	-	0.77
	RS331S12				130				40
50	RS331S00	50.4	60.3	± 0.4	70	320	1	-	0.91
	RS331S12				160				30
65	RS331S00	65.3	78.0	± 0.5	115	460	1	1	1.51
	RS331S12				200				35
80	RS331S00	80.2	94.8	± 0.5	130	660	2	2	2.28
	RS331S12				240				32
100	RS331S00	100.0	116.2	± 0.6	160	750	1	1	2.53
	RS331S12				290				16
125	RS330S00	126.2	145.0	± 0.6	350	1000	0.5	0.5	2.68
	RS330S12				148.2				10
150	RS330S00	151.6	171.0	± 1.4	400	1250	0.5	0.5	3.41
	RS330S12				174.2				10

6.3 HYDRA® annularly corrugated hoses - goods sold by the metre

RS 321

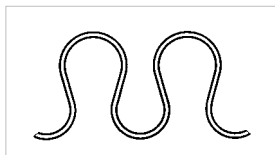
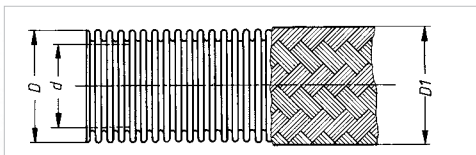

- Highly flexible annularly corrugated hose made of butt-welded pipe, mechanically corrugated
- Wall thickness: standard
- Corrugation: narrow
- Versions:
 - RS 321 S00 without braid
 - RS 321 S12 with single braid
- Maximum production length:
 - DN 6 - 32: 70 m
 - DN 40 - 50: 20 m
 - DN 65 - 100: 7 m
 longer hose assemblies available on request
- Standard materials:
 - Annularly corrugated hose 1.4404 or 1.4541
 - braid 1.4301
 Other materials are available on request.

6.3 HYDRA® annularly corrugated hoses - goods sold by the metre

DN	Type	Inside diameter	Outside diameter	Permissible deviation	Minimum bending radius	Nominal bending radius	Permissible static operating pressure at 20 °C SF4	Nominal pressure ISO 10380 SF4	Weight approx.		
					Single bend	Frequent movements					
-	-	d	D,D1	d,D,D1	r _{min}	r _n	P _{perm}	PN	-		
-	-	mm	mm	mm	mm	mm	bar	-	kg/m		
6	RS321S00	6.1	9.9	± 0.2	20	70	25	100	0.10		
	RS321S12				25					0.17	
8	RS321S00	8.2	12.5		30	80	16	100	0.14		
	RS321S12				30					0.25	
10	RS321S00	10.1	14.4		35	90	10	80	0.14		
	RS321S12				35					0.26	
12	RS321S00	12.1	17.0		40	100	8	50	0.17		
	RS321S12				40					0.30	
16	RS321S00	16.2	22.0		50	110	6	50	0.26		
	RS321S12				50					0.46	
20	RS321S00	20.2	26.8		± 0.3	50	130	4	40	0.31	
	RS321S12					55					0.53
25	RS321S00	25.5	32.2	65		150	4	40	0.49		
	RS321S12			65						0.90	
32	RS321S00	34.2	41.0	75		200	2.5	20	0.50		
	RS321S12			75						0.97	
40	RS321S00	40.0	49.8	± 0.4		80	210	1	1	1.13	
	RS321S12					90					1.81
50	RS321S00	50.1	60.5			110	240	1	1	1.34	
	RS321S12					110					2.10
65	RS321S00	65.0	78.2			± 0.5	145	280	1	1	1.96
	RS321S12						200				
80	RS321S00	80.0	95.0		240		400	1	1	3.12	
	RS321S12				240						4.92
100	RS321S00	99.4	116.8		± 0.6		240	500	1	1	3.70
	RS321S12						290				

6.3 HYDRA® annularly corrugated hoses - goods sold by the metre

RS 341

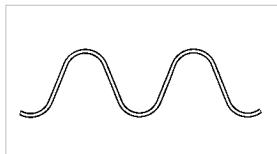
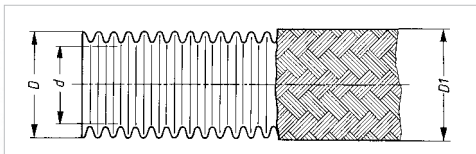

- Annularly corrugated hose made of butt-welded pipe, mechanically corrugated
- Wall thickness: standard
- Corrugation: wide
- Versions:
 - RS 341 S00 without braid
 - RS 341 S12 with single braid
- Maximum production lengths:
 - DN 6 - 8: 10 m
 - DN 10 - 50: 100 m
 - DN 65 - 100: 6.5 m
 Longer hose assemblies available of request
- Standard materials:
 - Annularly corrugated hose 1.4404 or 1.4541 braid 1.4301
 - Other materials are available on request.

6.3 HYDRA® annularly corrugated hoses - goods sold by the metre

DN	Type	Inside diameter	Outside diameter	Permissible deviation	Minimum bending radius	Nominal bending radius	Permissible static operating pressure at 20 °C	Nominal pressure	Weight approx.
-	-	d	D,D1	d,D,D1	r _{min}	r _n	p _{perm}	PN	-
-	-	mm	mm	mm	mm	mm	bar	-	kg/m
6	RS341S00	6.3	9.5	± 0.3	11	110	65	65	0.05
	RS341S12		10.6		25				
8	RS341S00	8.5	12.0	± 0.3	15	130	25	25	0.07
	RS341S12		13.4		32				
10	RS341S00	10.3	14.1	± 0.2	18	150	16	16	0.09
	RS341S12		15.5		38				
12	RS341S00	12.5	16.4	± 0.2	20	165	18	18	0.10
	RS341S12		18.0		45				
16	RS341S00	16.3	21.4	± 0.3	25	195	13	13	0.15
	RS341S12		23.0		58				
20	RS341S00	20.7	26.5	± 0.3	30	225	20	20	0.31
	RS341S12		28.1		70				
25	RS341S00	25.8	31.7	± 0.4	35	260	16	16	0.39
	RS341S12		33.7		85				
32	RS341S00	34.6	41.0	± 0.5	40	300	2.5	2.5	0.36
	RS341S12		43.0		105				
40	RS341S00	40.5	49.5	± 0.5	50	340	3	3	0.57
	RS341S12		51.5		130				
50	RS341S00	50.8	60.2	± 0.5	60	390	2.5	2.5	0.71
	RS341S12		62.5		160				
65	RS341S00	65.7	77.7	± 0.4	75	460	4	4	1.07
	RS341S12		80.9		200				
80	RS341S00	80.6	94.2	± 0.5	90	660	4	4	1.72
	RS341S12		97.4		240				
100	RS341S00	100.4	115.0	± 0.6	110	750	3	3	1.95
	RS341S12		118.2		290				

6.3 HYDRA® annularly corrugated hoses - goods sold by the metre

RS 531

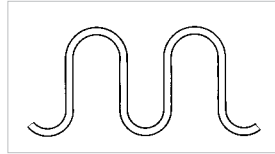
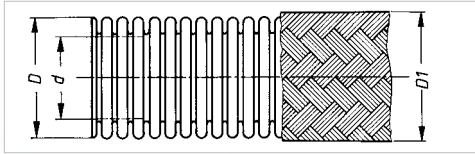

- Annularly corrugated hose made of butt-welded pipe, mechanically corrugated
- Wall thickness: increased
- Corrugation: standard
- Versions:
 - RS 531 S00 without braid
 - RS 531 S12 with single braid
 - RS 531 S22 with double braid
- Maximum production length:
 - DN 5 - 16: 100 m
- Standard materials:
 - Annularly corrugated hose 1.4404 or 1.4541
 - braid 1.4301
 - Other materials are available on request.

6.3 HYDRA® annularly corrugated hoses - goods sold by the metre

DN	Type	Inside diameter	Outside diameter	Permissible deviation	Minimum bending radius Single bend	Nominal bending radius Frequent movements	Permissible static operating pressure at 20 °C SF4	Nominal pressure ISO 10380 SF4	Weight approx.
-	-	d	D,D1	d,D,D1	r _{min}	r _n	P _{perm}	PN	-
-	-	mm	mm	mm	mm	mm	bar	-	kg/m
5	RS531S00	5,3	9,1	± 0,2	15	100	25	25	0,10
	RS531S12		10,2		25		150	150	0,14
	RS531S22		11,3		35		200	200	0,20
6	RS531S00	6,2	10,2	± 0,2	15	110	50	50	0,12
	RS531S12		11,6		25		200	200	0,23
	RS531S22		13,0		40		250	250	0,33
8	RS531S00	8,0	12,9	± 0,3	20	130	50	50	0,20
	RS531S12		14,5		32		200	200	0,35
	RS531S22		16,1		50		250	250	0,49
10	RS531S00	10,0	15,9	± 0,3	25	150	25	25	0,29
	RS531S12		17,5		38		150	150	0,48
	RS531S22		19,1		60		225	225	0,66
12	RS531S00	12,1	18,7	± 0,3	30	165	25	25	0,41
	RS531S12		20,3		45		100	100	0,62
	RS531S22		21,9		70		200	200	0,82
16	RS531S00	16,1	23,8	± 0,3	40	195	20	20	0,55
	RS531S12		25,8		58		150	150	0,92
	RS531S22		27,8		90		200	200	1,29

Special designs for higher pressures are available on request.

6.3 HYDRA® annularly corrugated hoses - goods sold by the metre

RS 430

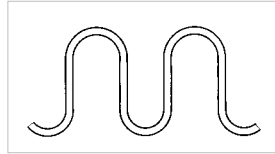
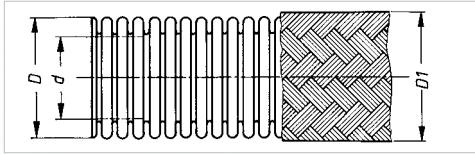

- Annularly corrugated hose made of butt-welded pipe, hydraulically shaped
- Wall thickness: increased
- Corrugation: standard
- Versions:
 - RS 430 S00 without braid
 - RS 430 S12 with single braid
 - RS 430 S22 with double braid
 - RS 430 S42 with single braid, knurled
 - RS 430 S52 with double braid, knurled
 - RS 430 S92 with double special braid
- Maximum production length:
 - DN 20 - 125: 10 m
 - DN 150 - 300: 3 m
 Longer hose assemblies can be produced from component parts on request.
- Standard materials:
 - annularly corrugated hose 1.4404 or 1.4541
 - braid, standard 1.4301, knurled 1.4306
 Other materials are available on request.

6.3 HYDRA® annularly corrugated hoses - goods sold by the metre

DN	Type	Inside diameter	Outside diameter	Permissible deviation	Minimum bending radius	Nominal bending radius	Permissible static operating pressure at 20 °C SF4	Nominal pressure ISO 10380 SF4	Weight approx.		
					Single bend	Frequent movements					
-	-	d	D,D1	d,D,D1	r _{min}	r _n	P _{perm}	PN	-		
-	-	mm	mm	mm	mm	mm	bar	-	kg/m		
20	RS430S00	20.2	29.2	± 0.3	45	285	6	6	0.54		
	RS430S12		31.2		70		90	65	0.93		
	RS430S22		33.2		70		125	100	1.31		
25	RS430S00	25.2	34.2	± 0.3	50	325	6	6	0.65		
	RS430S12		36.2		85		65	50	1.07		
	RS430S22		38.2		85		100	100	1.49		
32	RS430S00	33.7	42.7	± 0.3	60	380	4	4	0.77		
	RS430S12		45.0		105		65	65	1.41		
	RS430S22		47.2		105		80	80	2.05		
40	RS430S00	40.0	55.0	± 0.4	75	430	2.5	2.5	1.37		
	RS430S12		57.3		130		40	40	2.09		
	RS430S22		59.5		130		65	65	2.81		
50	RS430S00	50.0	65.0	± 0.4	90	490	2.5	2.5	1.61		
	RS430S12		68.2		160		50	50	2.91		
	RS430S22		71.3		160		80	65	4.15		
	RS430S00		79.8		110		580	0.5	0.5	2.06	
65	RS430S12	65.0	84.2	± 0.5	200	800	35	25	3.46		
	RS430S22		87.3		200		50	50	4.89		
	RS430S00		98.3		135		800	0.5	0.5	2.82	
80	RS430S12	79.8	101.5	± 0.5	240	800	25	16	4.65		
	RS430S22		104.6		240		50	25	6.46		
	RS430S00		117.8		160		1000	0.5	0.5	3.59	
100	RS430S12	99.8	121.0	± 0.6	290	1000	30	10	5.97		
	RS430S22		124.1		290		40	16	8.25		
	RS430S00		146.0		350		1250	0.5	0.5	5.23	
125	RS430S12	125.6	149.2	± 0.6	350	1250	16	10	7.80		
	RS430S22		152.4		30		16	10.30			
	RS430S00		177.4		400		800	0.2	-	4.97	
150	RS430S12	151.9	180.6	± 1.4	400	800	6	6	8.10		
	RS430S42		181.4				10	10	8.27		
	RS430S22		183.7				12	10	11.20		
	RS430S92		184.6				16	16	11.37		
	RS430S00		231.4				520	1100	0.2	-	7.92
	RS430S12		235				6	6	12.32		
200	RS430S42	202.2	236.9	± 1.6	520	1100	10	10	12.42		
	RS430S22		238.5				12	10	16.72		
	RS430S92		239.7				16	16	16.82		
	RS430S52		242.4				16	16	16.92		
	RS430S00		284.2				620	1350	0.2	-	13.0
	RS430S42		289.7				8	6	17.96		
250	RS430S52	248.4	295.2	± 1.6	620	1350	12	10	22.96		
	RS430S00		298.6				1000	1600	0.1	-	17.20
	RS430S42		341.3				4	4	23.03		
300	RS430S52	298.6	346.8	± 1.6	1000	1600	6	6	28.83		

6.3 HYDRA® annularly corrugated hoses - goods sold by the metre

RZ 331 - Bronze annularly corrugated hoses

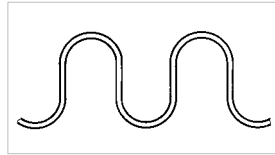
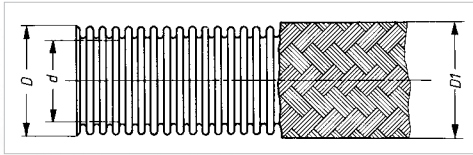

- Annularly corrugated hose made of butt-welded pipe, mechanically corrugated
- Wall thickness / corrugation: standard
- Versions:
 - RZ 331 S00 without braid
 - RZ 331 S13 with single braid
- Maximum production length:
 - DN 8 - 25: 50 m
 - DN 32 : 30 m
 - DN 40 - 50: 8 m
- Standard materials:
 - annularly corrugated hose 2.1010 (CuSn2)
 - braiding 2.1016 (CuSn4)

6.3 HYDRA® annularly corrugated hoses - goods sold by the metre

DN	Type	Inside diameter	Outside diameter	Permissible deviation	Minimum bending radius	Nominal bending radius	Nominal pressure DIN EN ISO 10380 SF4	Weight approx.
					Single bend	Frequent movements		
-	-	d	D,D1	d,D,D1	r_{min}	r_n	PN	-
-	-	mm	mm	mm	mm	mm	-	kg/m
8	RZ331S00	8.6	12.6	± 0.2	16	90	6	0.11
	RZ331S13		14.0		32			60
10	RZ331S00	10.7	15.1	± 0.2	18	130	6	0.13
	RZ331S13		16.5		38			45
12	RZ331S00	12.7	17.7	± 0.2	20	150	4	0.14
	RZ331S13		19.1		45			35
16	RZ331S00	16.7	22.2	± 0.2	28	170	4	0.24
	RZ331S13		23.6		58			32
20	RZ331S00	20.6	27.1	± 0.2	32	200	4	0.44
	RZ331S13		28.5		70			30
25	RZ331S00	25.6	33.2	± 0.3	40	230	2.5	0.46
	RZ331S13		35.5		85			30
32	RZ331S00	32.6	42.0	± 0.3	50	260	2.5	0.72
	RZ331S13		44.3		105			30
40	RZ331S00	40.5	52.0	± 0.3	60	310	1.6	0.95
	RZ331S13		54.0		130			25
50	RZ331S00	50.5	63.0	± 0.4	70	360	1.6	1.35
	RZ331S13		66.2		160			28

RS 351 - Semi-flexible annularly corrugated hoses

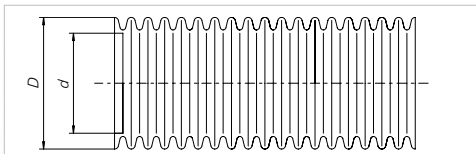

- Semi-flexible annularly corrugated hose, mechanically corrugated
- Wall thickness: standard
- Corrugation: very wide
- Versions:
RS 351 S00 without braid
- Maximum production length:
DN 12 - 25: 100 m
- Standard material:
1.4404

DN	Type	Inside diameter	Outside diameter	Permissible deviation	Minimum bending radius Single bend	Permissible operating pressure at 20 °C	Weight approx.
-	-	d	D	d,D	r _{min}	P _{perm}	-
-	-	mm	mm	mm	mm	bar	kg/m
12	RS351S00	12.5	16.6	± 0.3	20	18	0.095
16	RS351S00	16.7	21.3	± 0.3	16	17	0.125
20	RS351S00	20.5	26.4	± 0.4	20	9	0.165
25	RS351S00	25.8	31.7	± 0.4	35	10	0.36

The RS 351 is a semi-flexible hose and is primarily designed for static applications. This type of hose is not be used for the absorption of repeated movements and vibrations. The RS 351 is optimised for self-assembly fittings.

IX 331 - Semi-flexible annularly corrugated hoses

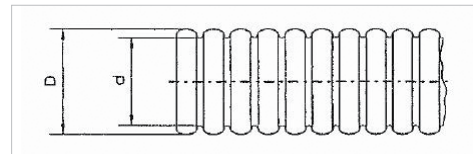

- Semi-flexible annularly corrugated hose, mechanically corrugated
- Wall thickness: standard
- Versions:
IX 331 S00 without braid
- Maximum production length:
DN 12 - 25: 100 m
- Standard material:
1.4404
- Corrugation: flat

DN	Type	Inside diameter	Outside diameter	Permissible deviation	Minimum bending radius Single bend	Permissible operating pressure at 20 °C	Weight approx.
-	-	d	D	d,D	r _{min}	P _{perm}	-
-	-	mm	mm	mm	mm	bar	kg/m
12	IX331S00	12.3	15.8	± 0.25	32	34	0.10
16	IX331S00	16.5	20.4	± 0.25	40	18	0.12
20	IX331S00	20.6	24.9	± 0.3	50	18	0.155
25	IX331S00	25.6	30.7	± 0.3	60	16	0.245

The IX 331 is a semi-flexible hose and is **exclusively** designed for static applications. This type of hose is not to be used for the absorption of repeated movements and vibrations. The IX 331 is optimised of self-assembly fittings.

ME 539 - semi-flexible helical corrugated hoses

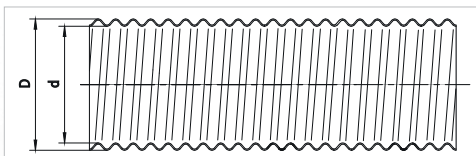

- Semi-flexible helical corrugated hoses, mechanically corrugated
- Wall thickness: increased
- Corrugation: very wide
- Versions:
 - ME 539 S00 without braid
- Maximum production length:
 - DN 25: 350 m
 - DN 32: 300 m
 - DN 40: 300 m
 - DN 50: 200 m
- Standard material:
 - 1.4404

DN	Type	Inside diameter	Outside diameter	Permissible deviation	Minimum bending radius Single bend	Permissible operating pressure at 20 °C	Weight approx.
-	-	d	D	d,D	r_{min}	P_{perm}	-
-	-	mm	mm	mm	mm	bar	kg/m
25	ME539S00	32	35,2	± 0,5	on request	16	0,335
32	ME539S00	40	44,8	± 0,5	on request	16	0,55
40	ME539S00	49	54,8	± 0,5	on request	16	0,85
50	ME539S00	61	66,6	± 0,5	on request	16	0,995

The ME 539 is a semi-flexible hose and is primarily designed for static applications. This type of hose is not be used for the absorption of repeated movements and vibrations. The ME 539 is intended for self-assembly fittings. Corresponding connecting components on request.

Connection fittings for HYDRA® corrugated hoses

A wide range of connections are available for HYDRA metal hoses. Depending on the operating conditions and the materials used, the hose and connector can be connected using fusion welding or brazing. A selection of common connection types is given below. The connection types are labelled according to the first two letters of the type designation of the individual hose assembly:

Flanged joints:

- A: Loose flange with welding collar
- B: Loose flange with collar connection piece
- C: Loose flange with welding rim swivel flange
- G: Welding neck flange

Threaded connections:

- L: Internal thread, fixed
- M: External thread, fixed
- N: Internal thread, swivel

Screw connections:

- Q: Internal thread
- R: External thread
- S: Pipe end

Pipe connection:

- U: All types of pipe fittings

Couplings:

- W: All types of couplings

6.4 Connection fittings

Connection fittings corrugated hoses

Type AB12, type AB22, type AB82

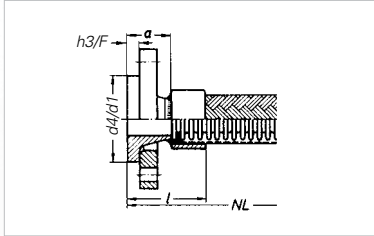

Flange connection, swivelling

Welding collar: steel or stainless steel 1.4541 or 1.4571

Loose flange: steel or stainless steel 1.4541 or 1.4571

Welded or brazed

Connection fitting type				Material		Permissible operating temperature
PN 10	PN 16	PN 25	PN 40	Welding neck	Flange	
AB12D	AB12E	AB12F	AB12G	Steel	Steel	480 °C*
AB82D	AB82E	AB82F	AB82G	Stainless steel	Steel	480 °C*
AB22D	AB22E	AB22F	AB22G	Stainless steel	Stainless steel	550 °C

Dimensions in mm, weight G in kg

DN	10	16	20	25	32	40	50	65	80	100	125	150	200	250	300
d4 / d1	40	45	58	68	78	88	102	122	138	158	188	212	268	320	370
h3 (DIN 2673)	10	10	12	12	12	12	14	14	16	16	18	18	20	22	22
F (DIN EN 1092)	12	12	14	14	14	14	16	16	16	18	18	20	20	22	22
a (DIN 2673)	35	35	40	40	40	40	45	45	50	50	50	55	55	60	60
a (DIN EN 1092)	35	38	40	40	42	45	45	45	50	52	55	55	62	68	68
l (DIN 2673)	45	49	56	58	60	62	70	73	80	82	86	90	100	110	115
l (DIN EN 1092)	45	52	56	58	62	67	70	73	80	84	91	95	107	118	123
G approx.	0.70	0.80	1.06	1.43	2.05	2.40	3.02	3.77	4.84	5.60	7.35	8.90	12.9	17.7	23.3

Connection dimensions PN 10 as per DIN 2501 / DIN EN 1092

* Applicable materials: see chapter 7.2

When ordering, please specify: connection fitting type, nominal diameter (DN), operating temperature, in case of stainless steel material no.

6.4 Connection fittings

Connection fittings corrugated hoses

Type BB12, type BB22, type BB82

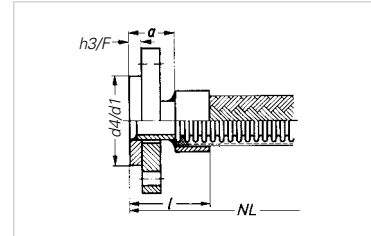

Flange connection, swivelling

Collar pipe: steel or stainless steel 1.4541 or 1.4571

Loose flange: steel or stainless steel 1.4541 or 1.4571

Welded or brazed

Connection fitting type				Material		Permissible operating temperature
PN 10	PN 16	PN 25	PN 40	Collar pipe	Flange	
BB12D	BB12E	BB12F	BB12G	Steel	Steel	480 °C*
BB82D	BB82E	BB82F	BB82G	Stainless steel	Steel	480 °C*
BB22D	BB22E	BB22F	BB22G	Stainless steel	Stainless steel	550 °C

Dimensions in mm, weight G in kg

DN	10	16	20	25	32	40	50	65	80	100	125	150	200	250	300
d4 / d1	40	45	58	68	78	88	102	122	138	158	188	212	268	320	370
h3 (DIN 2642)	10	10	12	12	12	12	14	14	16	16	18	18	20	22	22
F (DIN EN 1092)	12	12	14	14	14	14	16	16	16	18	18	20	20	22	22
a (DIN 2642)	45	45	46	51	51	51	57	57	63	68	79	79	85	85	90
a (DIN EN 1092)	46	46	57	52	52	52	58	58	63	69	79	80	85	85	90
l (DIN 2642)	55	59	62	69	71	73	82	85	93	100	115	119	130	135	145
l (DIN EN 1092)	56	60	63	70	72	74	83	86	93	101	115	120	130	135	145
G approx.	0.72	0.84	1.08	1.48	2.13	2.46	3.08	3.90	5.00	5.75	8.00	9.80	13.5	18.4	24.3

Connection dimensions PN 10 as per DIN 2501 / DIN EN 1092

* Applicable materials: see chapter 7.2

When ordering, please specify: connection fitting type, nominal diameter (DN), operating temperature, in case of stainless steel material no.

6.4 Connection fittings

Connection fittings corrugated hoses

Type CA22, type CA82

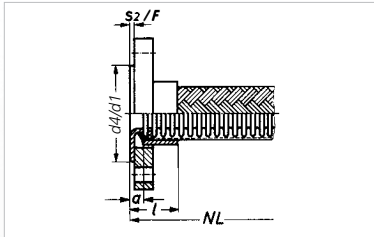

Flange connection, swivelling

Welding rim: stainless steel 1.4541 or 1.4571

Loose flange: steel or stainless steel 1.4541 or 1.4571

Welded or brazed

Connection fitting type		Material		Permissible operating temperature
PN 10	PN 16 (to DN 150)	Welding rim	Flange	
CA82D	CA82E	Stainless steel	Steel	480 °C*
CA22D	CA22E	Stainless steel	Stainless steel	550 °C

Dimensions in mm, weight G in kg

DN	10	16	20	25	32	40	50	65	80	100	125	150	200	250	300
d4 / d1	40	45	58	68	78	88	102	122	138	158	188	212	268	320	370
s2 (DIN 2642)	3	3	3	3,5	3,5	3,5	3,5	3,5	4	4	4	4	4	5	5
F (DIN EN 1092)	2,5	2,5	3	3	3	3	4	4	4	4	4	4	5	-	-
a (DIN 2642)	9	9	12	15	15	17	23	23	23	28	30	30	30	30	35
H5 (DIN EN 1092)	7	7	8	10	12	15	20	20	25	25	25	25	30	-	-
l (DIN 2673)	19	23	28	33	35	39	48	51	53	60	66	70	75	80	90
l (DIN EN 1092)	17	21	24	28	32	37	45	48	55	57	61	65	75	-	-
G approx.	0.63	0.71	0.84	1.15	1.68	1.90	2.21	2.88	3.55	3.86	4.95	6.00	8.2	11.0	13.7

Connection dimensions PN 10 as per DIN 2501 / DIN EN 1092

* Applicable materials: see chapter 7.2

When ordering, please specify: connection fitting type, nominal diameter (DN), operating temperature, in case of stainless steel material no.

6.4 Connection fittings

Connection fittings corrugated hoses

Type GB12, type GB22

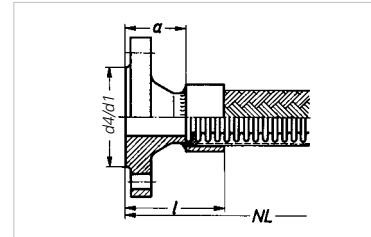

Flange connection, fixed

Welding neck flange steel or stainless steel 1.4541 or 1.4571

Welded or brazed

Connection fitting type				Material Flange	Permissible operating temperature
PN 10	PN 16	PN 25	PN 40		
GB12D	GB12E	GB12F	GB12G	Steel	480 °C*
GB22D	GB22E	GB22F	GB22G	Stainless steel	550 °C

Dimensions in mm, weight G in kg

DN	10	16	20	25	32	40	50	65	80	100	125	150	200	250	300
d4 / d1	40	45	58	68	78	88	102	122	138	158	188	212	268	320	370
a (DIN 2632)	35	35	38	38	40	42	45	45	50	52	55	55	62	68	68
a (DIN EN 1092)	35	38	40	40	42	45	45	45	50	52	55	55	62	68	68
l (DIN 2632)	45	49	54	56	60	64	70	73	80	84	91	95	107	118	123
l (DIN EN 1092)	45	52	56	58	62	67	70	73	80	84	91	95	107	118	123
G approx.	0.60	0.67	1.00	1.20	1.76	2.00	2.66	3.30	3.95	4.95	6.75	8.35	12.4	16.1	20.0

Connection dimensions PN 10 as per DIN 2501 / DIN EN 1092

* Applicable materials: see chapter 7.2

When ordering, please specify: connection fitting type, nominal diameter (DN), operating temperature, in case of stainless steel material no.

6.4 Connection fittings

Connection fittings corrugated hoses

Type LA12S, type LA22S, type LA52S

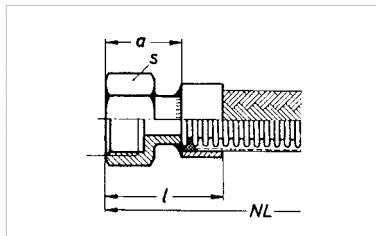

Threaded connection, fixed

Hexagon socket with Whitworth pipe thread DIN EN 10226 (ISO 7/1)

Made of steel, stainless steel 1.4541 or 1.4571 or brass

Welded or brazed

Connection fitting type	Material	Permissible operating temperature
LA12S	Steel	300 °C
LA22S	Stainless steel	550 °C
LA52S	Brass	250 °C

Dimensions in mm, weight G in kg

PN	100						63				40	
	6	8	10	12	16	20	25	32	40	50	65	80
d	R¼	R¼	R¾	R½	R½	R¾	R1	R1¼	R1½	R2	R2½	R3
a	19	19	21	24	24	27	31	34	36	42	49	54
l	27	29	31	36	38	43	49	54	58	67	77	84
s	17	17	22	24	24	32	41	46	55	65	85	100
G	0.02	0.03	0.04	0.06	0.07	0.10	0.19	0.22	0.31	0.41	0.86	1.22
approx.												

When ordering, please specify: connection fitting type, nominal diameter (DN), operating temperature, in case of stainless steel material no.

6.4 Connection fittings

Connection fittings corrugated hoses

Type MA12S, type MA22S, type MA52S

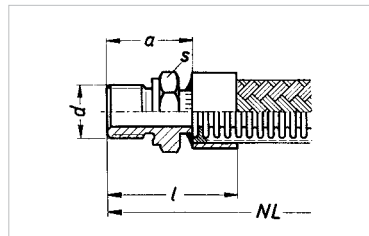

Threaded connection, fixed

Hexagon nipple with Whitworth pipe thread ISO 228/1

Made of steel, stainless steel 1.4541 or 1.4571 or brass

Welded or brazed

Connection fitting type	Material	Permissible operating temperature
MA12S	Steel	300 °C
MA22S	Stainless steel	550 °C
MA52S	Brass	250 °C

Dimensions in mm, weight G in kg

PN	250				160		100			63		40	
	6	8	10	12	16	20	25	32	40	50	65	80	100
d	G¼A	G¼A	G¾A	G½A	G½A	G¾A	G1A	G1¼A	G1½A	G2A	G2½A	G3A	G4A
a	24	25	25	29	29	32	38	40	43	45	52	54	64
l	32	35	35	41	43	48	56	60	65	70	78	84	96
s	19	19	22	27	27	32	41	50	55	70	85	100	120
G	0.04	0.04	0.06	0.08	0.08	0.12	0.2	0.29	0.32	0.47	0.75	0.85	1.35
approx.													

When ordering, please specify: connection fitting type, nominal width (DN), operating temperature, in case of stainless steel material no.

Also available with metric fine thread on request.

6.4 Connection fittings

Connection fittings corrugated hoses

Type MH02S

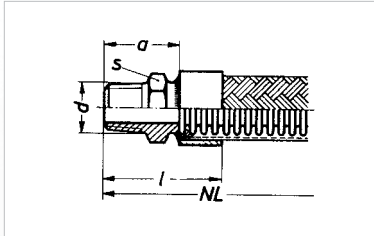

Threaded connection, fixed

Hexagon nipple with Whitworth pipe thread DIN EN10226 (ISO 7/1)

Made of malleable iron

Brazed

Connection fitting type	Permissible operating temperature	Permissible operating pressure
MH02S	Chapter 7.3	Chapter 7.3

Dimensions in mm, weight G in kg

DN	10	12	16	20	25	32	40	50	65	80
d	R ³ / ₈	R ¹ / ₂	R ¹ / ₂	R ³ / ₄	R1	R1 ¹ / ₄	R1 ¹ / ₂	R2	R2 ¹ / ₂	R3
a	32	35	35	39	42	45	48	52	55	60
l	42	47	49	55	60	65	70	77	83	90
s	22	28	28	32	42	50	55	70	85	100
G approx.	0.06	0.08	0.08	0.12	0.18	0.26	0.29	0.49	0.85	1.26

6.4 Connection fittings

Connection fittings corrugated hoses

Type MH12S, type MH22S, type MH52S

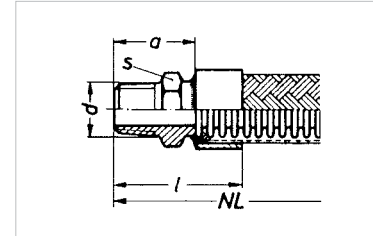

Threaded connection, fixed

Hexagon nipple with Whitworth pipe thread DIN EN 10226 (ISO 7/1)

Made of steel, stainless steel 1.4541 or 1.4571 or brass

Welded or brazed

Connection fitting type	Material	Permissible operating temperature
MH12S	Steel	300 °C
MH22S	Stainless steel	550 °C
MH52S	Brass	250 °C

Dimensions in mm, weight G in kg

PN	100							63			40		
DN	6	8	10	12	16	20	25	32	40	50	65	80	
d	R ¹ / ₄	R ¹ / ₄	R ³ / ₈	R ¹ / ₂	R ¹ / ₂	R ³ / ₄	R1	R1 ¹ / ₄	R1 ¹ / ₂	R2	R2 ¹ / ₂	R3	
a	24	24	25	29	29	32	38	40	40	47	52	56	
l	32	34	35	41	43	48	56	60	62	72	80	86	
s	14	14	17	22	22	27	36	46	50	60	80	90	
G approx.	0.02	0.03	0.04	0.05	0.06	0.09	0.14	0.23	0.25	0.43	0.65	0.75	

When ordering, please specify: connection fitting type, nominal diameter (DN), operating temperature, in case of stainless steel material no.

6.4 Connection fittings

Connection fittings corrugated hoses

Type NA12S, type NA22S, type NA52S

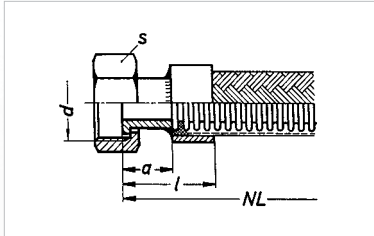

Threaded connection, swivelling

Collar pipe, flat sealing, union nut with Whitworth pipe thread ISO 228/1 made of steel, stainless steel 1.4541 or 1.4571 or brass

Welded or brazed

Connection fitting type	Material	Permissible operating temperature
NA12S	Steel	300 °C
NA22S	Stainless steel	550 °C
NA52S	Brass	250 °C

NA12S, NA22S: dimensions in mm, weight G in kg

PN	100					63					40
	6	8	10	12	16	20	25	32	40	50	
d	G¼	G⅜	G½	G⅝	G¾	G1	G1¼	G1½	G1¾	G2¼	
a	20	21	21	24	24	24	26	26	29	29	
l	28	31	31	36	38	40	44	46	51	54	
s	17	22	27	27	32	41	50	55	65	75	
G approx.	0.03	0.04	0.07	0.08	0.10	0.15	0.25	0.28	0.49	0.54	

When ordering, please specify: connection fitting type, nominal diameter (DN), operating temperature, in case of stainless steel material no.

NA52S:

PN 25 for all DN, other dimensions, see table NA12S, NA22S

6.4 Connection fittings

Connection fittings corrugated hoses

Type NF12S, type NF22S, type NF52S

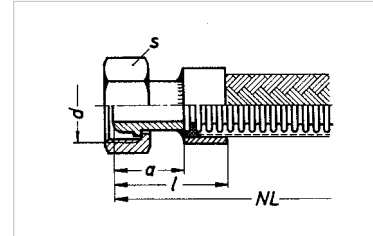

Threaded connection, swivelling

Ball lining as per DIN 3863, union nut with Whitworth pipe thread ISO 228/1 made of steel, stainless steel 1.4541 or 1.4571 or brass

Welded or brazed

Connection fitting type	Material	Permissible operating temperature
NF12S	Steel	300 °C
NF22S	Stainless steel	550 °C
NF52S	Brass	250 °C

NF12S, NF22S: dimensions in mm, weight G in kg

PN	100					63					40
	6	8	10	12	16	20	25	32	40	50*	
d	G¼	G⅜	G½	G⅝	G¾	G1	G1¼	G1½	G1¾	G2¼	
a	24	24	24	29	29	29	31	31	31	34	
l	32	34	34	41	43	45	49	51	53	59	
s	17	22	27	27	32	41	50	55	65	75	
G approx.	0.03	0.04	0.07	0.08	0.10	0.15	0.28	0.29	0.47	0.58	

* DN 50 is not standardised! When ordering, please specify: connection fitting type, nominal diameter (DN), operating temperature, in case of stainless steel material no.

NF52S:

PN 25 for all DN, other dimensions see table NF12S, NF22S

6.4 Connection fittings

Connection fittings corrugated hoses

Type NI12S, type NI22S, type NI52S

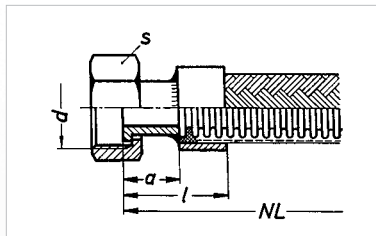

Threaded connection, swivelling

Collar pipe, flat sealing, union nut with metric thread DIN 3870, series LL, made of steel, stainless steel 1.4541 or 1.4571 or brass

Welded or brazed

Connection fitting type	Material	Permissible operating temperature
NI12S	Steel	300 °C
NI22S	Stainless steel	550 °C
NI52S	Brass	250 °C

NI12S, NI22S: dimensions in mm, weight G in kg

PN	100					63				40
DN	6	8	10	12	16	20	25	32	40	50
d	M14x1.5	M16x1.5	M18x1.5	M22x1.5	M26x1.5	M30x1.5	M38x1.5	M45x1.5	M52x1.5	M65x2
a	20	21	21	24	24	24	26	26	29	29
l	28	31	31	36	38	40	44	46	51	54
s	17	19	22	27	32	36	46	50	60	75
G approx.	0.03	0.04	0.05	0.07	0.10	0.12	0.19	0.28	0.34	0.45

When ordering, please specify: connection fitting type, nominal diameter (DN), operating temperature, in case of stainless steel material no.

NI52S:

PN 25 for all DN, other dimensions see table NI12S, NI22S

6.4 Connection fittings

Connection fittings corrugated hoses

Type NL12Q, type NL22Q

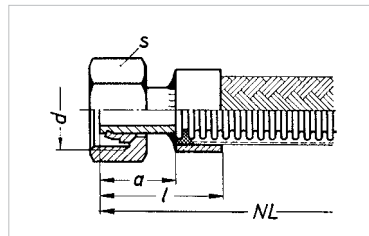

Threaded connection, swivelling

Precision pipe with cutting ring DIN 3861, DIN EN ISO 8434-1

Union nut with metric thread according to DIN EN ISO 8434-1, series L

Made of steel or stainless steel 1.4541 or 1.4571 (union nut 1.4571),

Welded or brazed

Connection fitting type	Material	Permissible operating temperature
NL12Q	Steel	300 °C
NL22Q	Stainless steel	400 °C

Dimensions in mm, weight G in kg

PN		250				160		100		
DN	4	6	8	10	12	16	20	25	32	40
Pipe dimensions	6x1	8x1	10x1.5	12x1.5	15x2	18x1.5	22x2	28x2	35x2	42x3
d	M12x1.5	M14x1.5	M16x1.5	M18x1.5	M22x1.5	M26x1.5	M30x2	M36x2	M45x2	M52x2
a	28	28	30	30	32	32	36	40	45	45
l	36	36	40	40	44	46	52	58	65	67
s	14	17	19	22	27	32	36	41	50	60
G approx.	0.04	0.04	0.04	0.06	0.09	0.11	0.16	0.21	0.31	0.44

When ordering, please specify: connection fitting type, nominal diameter (DN), operating temperature, in case of stainless steel material no.

6.4 Connection fittings

Connection fittings corrugated hoses

Type NN12Q, type NN22Q,

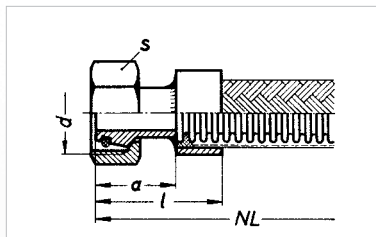

Threaded connection, swivelling 24° sealing cone with O-ring*, union nut DIN ISO 12151-2, series L made of steel or stainless steel 1.4541 or 1.4571 (union nut 1.4571), welded or brazed

Connection fitting type	Material		Permissible operating temperature*
	Threaded connection	O-ring	
NN12Q	Steel	NBR (buna N)	-20 to + 90 °C
NN22Q	Stainless steel	or FPM (Viton)	-20 to + 200 °C

*O-ring with DVGW certification can be used up to +80 °C

Dimensions in mm, weight G in kg

PN	250				160			100	
	6	8	10	12	16	20	25	32	40
DN	6	8	10	12	16	20	25	32	40
d	M14x1.5	M16x1.5	M18x1.5	M22x1.5	M26x1.5	M30x2	M36x2	M45x2	M52x2
a	32	35	35	35	38	40	44	46	50
l	40	45	45	47	52	56	62	66	72
s	17	19	22	27	32	36	41	55	60
G approx.	0.03	0.04	0.05	0.07	0.11	0.15	0.21	0.31	0.48
Associated outer pipe diameter	8	10	12	15	18	22	28	35	42

When ordering, please specify: connection fitting type, nominal width (DN), operating temperature, material for O-ring, in case of stainless steel material no.

Note: This threaded connection is suitable for the 24° conical fitting according to DIN EN ISO 8434-1, series L or for connection to threaded pins with bore shape W (24°), series L according to DIN 3861.

6.4 Connection fittings

Connection fittings corrugated hoses

Type NN12R, type NN22R

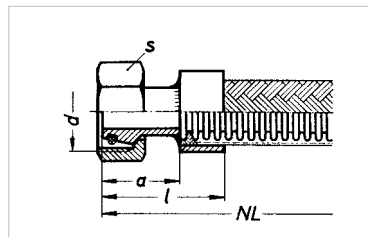

Threaded connection, swivelling 24° sealing cone with O-ring*, union nut DIN ISO 12151-2, series S made of steel or stainless steel 1.4541 or 1.4571 (union nut 1.4571), welded or brazed

Connection fitting type	Material		Permissible operating temperature*
	Threaded connection	O-ring	
NN12R	Steel	NBR (buna N)	-20 to + 90 °C
NN22R	Stainless steel	or FPM (Viton)	-20 to + 200 °C

*O-ring with DVGW certification can be used up to +80 °C

Dimensions in mm, weight G in kg

PN	630			400			250	
	6	8	10	12	16	20	25	32
DN	6	8	10	12	16	20	25	32
d	M18x1.5	M20x1.5	M22x1.5	M24x1.5	M30x2	M36x2	M42x2	M52x2
a	35	35	35	35	40	44	48	50
l	43	45	45	47	54	60	66	70
s	22	24	27	30	36	46	50	60
G approx.	0.05	0.06	0.08	0.1	0.16	0.30	0.37	0.58
Associated outer pipe diameter	10	12	14	16	20	25	30	38

When ordering, please specify: connection fitting type, nominal width (DN), operating temperature, material for O-ring, in case of stainless steel material no.

Note: This threaded connection is suitable for the 24° conical fitting according to DIN EN ISO 8434-1, series S or for connection to threaded pin with bore shape W (24°), series S according to DIN 3861.

6.4 Connection fittings

Connection fittings corrugated hoses

Type NO12S, type NO22S, type NO52S

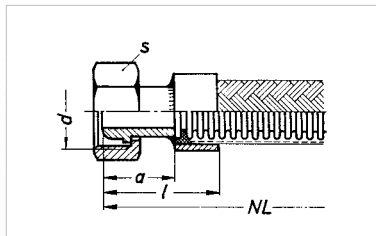

Threaded connection, swivelling
Ball type bushing according to
DIN 3863, union nut with metric
thread DIN 3870, series LL made of
steel, stainless steel 1.4541 or 1.4571
or brass, welded or brazed

Connection fitting type	Material	Permissible operating temperature
NO12S	Steel	300 °C
NO22S	Stainless steel	550 °C
NO52S	Brass	250 °C

NO12S, NO22S: dimensions in mm, weight G in kg

PN	100						63				40	25
	6	8	10	12	16	20	25	32	40	*50	*65	
d	M14x1.5	M16x1.5	M18x1.5	M22x1.5	M26x1.5	M30x1.5	M38x1.5	M45x1.5	M52x1.5	M65x2	M78x2	
a	24	24	24	29	29	29	31	31	31	34	40	
l	32	34	34	41	43	45	49	51	53	59	68	
s	17	19	22	27	32	36	46	50	60	75	90	
G	0.03	0.04	0.05	0.08	0.10	0.12	0.22	0.30	0.31	0.48	0.72	
approx.												

* DN 50 + 65 is not standardised!

When ordering, please specify: connection fitting type, nominal diameter (DN), operating temperature, with stainless steel material no.

NO52S:

PN 25 for all DN, other dimensions see table NF12S, NF22S

Note: This threaded connection is suitable for connection to the bore shapes U and Y (60°) as per DIN 3863.

6.4 Connection fittings

Connection fittings corrugated hoses

Type QA02S

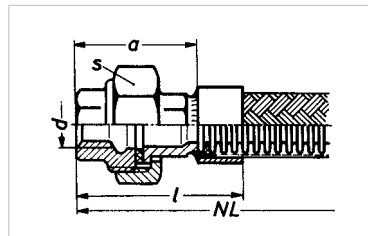

Threaded fitting, internal thread
Flat sealing
With Whitworth pipe thread DIN EN
10226 (ISO 7/1)
Made of malleable iron, brazed

Connection fitting type	Permissible operating temperature	Permissible operating pressure
QA02S	Chapter 7.3	Chapter 7.3

Dimensions in mm, weight G in kg

DN	6	8	10	12	16	20	25	32	40	50
d	Rp $\frac{1}{4}$	Rp $\frac{1}{4}$	Rp $\frac{3}{8}$	Rp $\frac{1}{2}$	Rp $\frac{1}{2}$	Rp $\frac{3}{4}$	Rp1	Rp1 $\frac{1}{4}$	Rp1 $\frac{1}{2}$	Rp2
a	52	52	54	59	59	65	70	78	85	94
l	60	62	64	71	73	81	88	98	107	119
s	28	28	32	39	39	48	55	67	74	90
G	0.11	0.12	0.14	0.18	0.19	0.31	0.42	0.68	0.87	1.31
approx.										

When ordering, please specify: connection fitting type, nominal diameter (DN), operating temperature

6.4 Connection fittings

Connection fittings corrugated hoses

Type QB02S

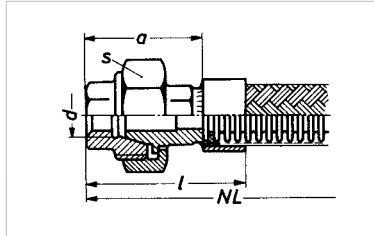

Threaded fitting, internal thread
Conical seal,
With Whitworth pipe thread DIN EN 10226 (ISO 7/1)
Made of malleable iron, brazed

Connection fitting type	Permissible operating temperature	Permissible operating pressure
QB02S	Chapter 7.3	Chapter 7.3

Dimensions in mm, weight G in kg

DN	6	8	10	12	16	20	25	32	40	50
d	Rp $\frac{1}{4}$	Rp $\frac{1}{4}$	Rp $\frac{3}{8}$	Rp $\frac{1}{2}$	Rp $\frac{1}{2}$	Rp $\frac{3}{4}$	Rp1	Rp $\frac{1}{4}$	Rp $\frac{1}{2}$	Rp2
a	52	52	54	59	59	65	70	78	85	94
l	60	62	64	71	73	81	88	98	107	119
s	28	28	32	39	39	48	55	67	74	90
G approx.	0.11	0.12	0.14	0.19	0.20	0.33	0.44	0.72	0.88	1.37

When ordering, please specify: connection fitting type, nominal diameter (DN), operating temperature

6.4 Connection fittings

Connection fittings corrugated hoses

Type QB12W, type QB22W, type QB52W

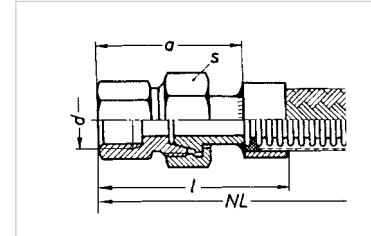

Threaded fitting, internal thread
Conical sealing with 24° cone angle
Suitable for bore shape W DIN 3861 L, DIN EN ISO 8434-1 with Whitworth pipe thread DIN EN 10226 (ISO 7/1) made of steel, stainless steel 1.4541 or 1.4571 (union nut 1.4301) or brass
Welded or brazed

Connection fitting type	Material	Permissible operating temperature
QB12W	Steel	300 °C
QB22W	Stainless steel	550 °C
QB52W	Brass	250 °C

Dimensions in mm, weight G in kg

PN	100							63		
	6	8	10	12	16	20	25	32	40	50
d	Rp $\frac{1}{4}$	Rp $\frac{1}{4}$	Rp $\frac{3}{8}$	Rp $\frac{1}{2}$	Rp $\frac{1}{2}$	Rp $\frac{3}{4}$	Rp1	Rp $\frac{1}{4}$	Rp $\frac{1}{2}$	Rp2
a	43	44	47	52	53	60	66	71	75	83
l	51	54	57	64	67	76	84	91	97	108
s	17	19	22	27	32	36	41	50	60	70
G approx.	0.05	0.06	0.08	0.13	0.16	0.21	0.31	0.48	0.61	0.81

When ordering, please specify: connection fitting type, nominal diameter (DN), operating temperature, in case of stainless steel materials no.

6.4 Connection fittings

Connection fittings corrugated hoses

Type RB12W, type RB22W, type RB52W

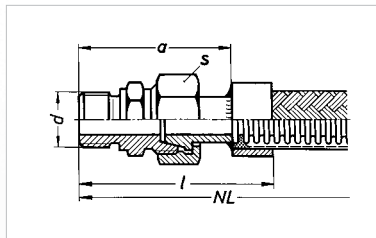

Threaded fitting, external thread
Conical sealing with 24° cone angle
Suitable for bore shape W according to DIN 3861 L, DIN EN ISO 8434-1 L
With Whitworth pipe thread ISO 228/1
made of steel, stainless steel 1.4541 or 1.4571 (union nut 1.4301) or brass
welded or brazed

Connection fitting type	Material	Permissible operating temperature
RB12W	Steel	300 °C
RB22W	Stainless steel	550 °C
RB52W	Brass	250 °C

Dimensions in mm, weight G in kg

PN	100							63		
	6	8	10	12	16	20	25	32	40	50
DN	G ¹ / ₄ A	G ¹ / ₄ A	G ³ / ₈ A	G ¹ / ₂ A	G ¹ / ₂ A	G ³ / ₄ A	G1A	G1 ¹ / ₄ A	G1 ¹ / ₂ A	G2A
a	49	51	54	59	60	68	74	79	83	92
l	57	61	64	71	74	84	92	99	105	117
s	17	19	22	27	32	36	41	50	60	70
G approx.	0.05	0.06	0.08	0.13	0.16	0.21	0.32	0.5	0.68	0.93

When ordering, please specify: connection fitting type, nominal diameter (DN), operating temperature, in case of stainless steel material no.

6.4 Connection fittings

Connection fittings corrugated hoses

Special applications type RD16, type RD26

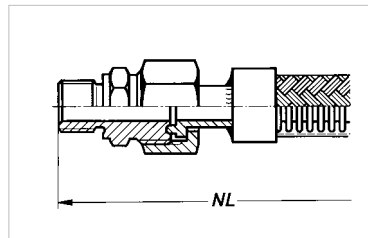

Threaded fitting for high pressure, external thread
Without intermediate seal, metal sealing
With Whitworth pipe thread ISO 228/1
Made of steel 1.0460 or stainless steel
Welded

Connection fitting type		Material	Permissible operating temperature
PN 100	PN 200		
RD16S	RD16W	Steel	350 °C
RD26S	RD26W	Stainless steel	400 °C

Dimensions in mm, weight G in kg

Application

- High pressure (also for pulsations, oscillations)
- Vacuum
- Critical media (e.g. superheated steam, heat transfer oil)
- High temperatures

Nominal diameter

DN 6 to DN 50

Operating pressure

According to the table, higher pressure stages on request

Operating temperature

According to the table, higher operating temperatures on request

When ordering, please specify

- Connection fitting type
- Nominal diameter (DN)
- Operating temperature

6.4 Connection fittings

Connection fittings corrugated hoses

Type RE02S

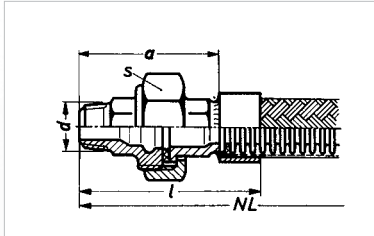

Threaded fitting, external thread
Flat sealing
with Whitworth pipe thread DIN EN 10226 (ISO 7/1)
Made of malleable iron
Brazed

Connection fitting type	Permissible operating temperature	Permissible operating pressure
RE02S	Chapter 7.3	Chapter 7.3

Dimensions in mm, weight G in kg

DN	12	16	20	25	32	40
d	R½	R½	R¾	R1	R1¼	R1½
a	77	77	86	93	103	111
l	89	91	102	111	123	133
s	39	39	48	55	67	74
G approx.	0.21	0.22	0.33	0.48	0.74	0.91

When ordering, please specify: connection fitting type, nominal diameter (DN), operating temperature

6.4 Connection fittings

Connection fittings corrugated hoses

Type RF02S

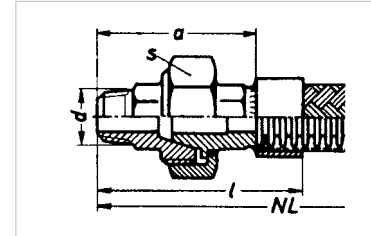

Threaded fitting, external thread
Conical sealing
With Whitworth pipe thread DIN EN 10226 (ISO 7/1)
Made of malleable iron
Brazed

Connection fitting type	Permissible operating temperature	Permissible operating pressure
RF02S	Chapter 7.3	Chapter 7.3

Dimensions in mm, weight G in kg

DN	6	8	10	12	16	20	25	32	40	50
d	R¼	R¼	R⅜	R½	R½	R¾	R1	R1¼	R1½	R2
a	66	66	69	77	77	86	93	103	111	123
l	74	76	79	89	91	102	111	123	133	148
s	28	28	32	39	39	50	55	67	74	90
G approx.	0.11	0.11	0.15	0.22	0.23	0.35	0.51	0.78	0.99	1.50

When ordering, please specify: connection fitting type, nominal diameter (DN), operating temperature

6.4 Connection fittings

Connection fittings corrugated hoses

Type RF12W, type RF22W, type RF52W

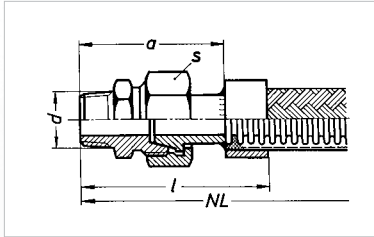

Threaded fitting, external thread
Conical sealing with 24° cone angle
Suitable for bore shape W DIN 3861L,
DIN EN ISO 8434-1
With Whitworth pipe thread DIN EN
10226 (ISO 7/1)
Made of steel, stainless steel 1.4541
or 1.4571 or brass
Welded or brazed

Connection fitting type	Material	Permissible operating temperature
RF12W	Steel	300 °C
RF22W	Stainless steel	550 °C
RF52W	Brass	250 °C

Dimensions in mm, weight G in kg

PN	100							63		
	6	8	10	12	16	20	25	32	40	50
DN	R¼	R¼	R⅜	R½	R½	R¾	R1	R1¼	R1½	R2
d	47	49	52	59	60	67	74	80	82	93
l	55	59	62	71	74	83	92	100	104	118
s	17	19	22	27	32	36	41	50	60	70
G approx.	0.05	0.06	0.08	0.13	0.16	0.21	0.32	0.5	0.68	0.93

When ordering, please specify: connection fitting type, nominal diameter (DN), operating temperature, in case of stainless steel material no.

6.4 Connection fittings

Connection fittings corrugated hoses

Special applications type RM16, type RM26

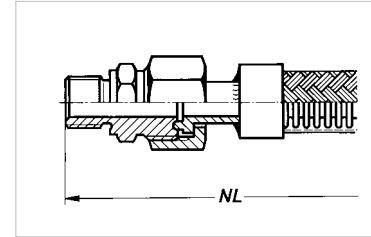

Threaded fitting for high pressure,
external thread
Without intermediate seal,
metal sealing
With metric ISO thread
according to DIN 13
Made of steel 1.0460 or stainless steel
Welded

Connection fitting type		Material	Permissible operating temperature
PN 100	PN 200		
RM16S	RM16W	Steel	350 °C
RM26S	RM26W	Stainless steel	400 °C

Application

- High pressure
(also for pulsations, oscillations)
- Vacuum
- Critical media
(e.g. superheated steam, heat transfer oil)
- High temperatures

Nominal diameter

DN 6 to DN 50

Operating pressure

According to the table,
higher pressure stages on request

Operating temperature

According to the table,
higher operating temperatures on request

When ordering, please specify

- Connection fitting type
- Nominal diameter (DN)
- Operating temperature

6.4 Connection fittings

Connection fittings corrugated hoses

Special applications type RN16, type RN26

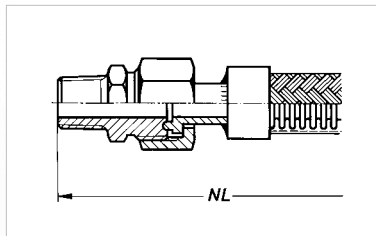

Threaded fitting for high pressure,
external thread
Without intermediate seal,
metal sealing
With conical NPT thread ANSI B1.20.1
Made of steel 1.0460 or stainless steel
welded

Connection fitting type		Material	Permissible operating temperature
PN 100	PN 200		
RN16S	RN16W	Steel	350 °C
RN26S	RN26W	Stainless steel	400 °C

Application

- High pressure
(also for pulsations, oscillations)
- Vacuum
- High temperatures

Nominal diameter

DN 6 to DN 50

Operating pressure

According to the table,
higher pressure stages on request

Operating temperature

According to the table,
higher operating temperatures on request

When ordering, please specify

- Connection fitting type
- Nominal diameter (DN)
- Operating temperature

6.4 Connection fittings

Connection fittings corrugated hoses

Type SS12W, type SS22W

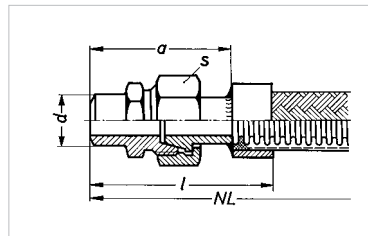

Threaded fitting, welding end
Conical sealing with 24° cone angle
Suitable for bore shape W DIN 3861 L,
DIN EN ISO 8434-1 L
With welding end,
pipe dimension ISO
Made of steel or
stainless steel 1.4541 or 1.4571
welded or brazed

Connection fitting type	Material	Permissible operating temperature
SS12W	Steel	300 °C
SS22W	Stainless steel	550 °C

Dimensions in mm, weight G in kg

PN	100							63		
	6	8	10	12	16	20	25	32	40	50
d	10.2	13.5	17.2	21.3	21.3	26.9	33.7	42.4	48.3	60.3
a	45	47	49	52	53	61	65	70	74	83
l	53	57	59	64	67	77	83	90	96	108
s	17	19	22	27	32	36	41	50	60	70
G approx.	0.04	0.05	0.07	0.11	0.13	0.23	0.29	0.44	0.64	1.01

When ordering, please specify: connection fitting type, nominal diameter (DN), operating temperature, in case of stainless steel material no.

6.4 Connection fittings

Connection fittings corrugated hoses

Special applications Type ST16, type ST26

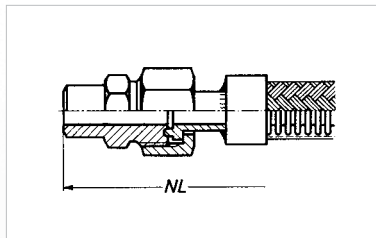

Threaded fitting for high pressure, welding end
Without intermediate seal, metallic seal made of steel 1.0460 or stainless steel
Welded

Connection fitting type		Material	Permissible operating temperature
PN 100	PN 200		
ST16S	ST16W	Steel	350 °C
ST26S	ST26W	Stainless steel	400 °C

Application

- High pressure (also for pulsations, oscillations)
- Vacuum
- Critical media (e.g. superheated steam, heat transfer oil)
- High temperatures

Operating pressure

According to the table, higher pressure stages on request

Operating temperature

According to the table, higher operating temperatures on request

Nominal diameter

DN 6 to DN 50

When ordering, please specify

- Connection fitting type
- Nominal diameter (DN)
- Operating temperature

6.4 Connection fittings

Connection fittings corrugated hoses

Special applications Type SY22S, type SY22U, type SY22V

Threaded fitting DIN 11851 for liquid foodstuffs
Made of stainless steel 1.4301, burr and gap-free welded, sterilisable

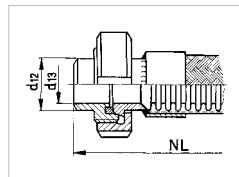

Type SY22S
Ball-type socket with grooved union nut with round thread DIN 405.
Threaded pipe socket with welding end.

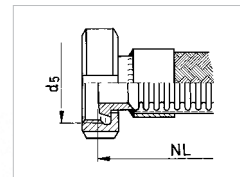

Type SY22U
Ball-type socket with grooved union nut with round thread DIN 405.

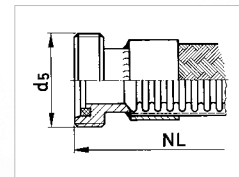

Type SY22V
Threaded pipe socket with sealing ring.

Connection fitting type	Material		Permissible operating temperature
	Screw connection	Sealing ring	
SY22S	Stainless steel 1.4301	NBR (buna N)	-20 to +230 °C Depending on sealing material and flow medium
SY22U	Other material no.	FPM (Viton)	
SY22V	On request	MVQ (silicon) or PTFE (Teflon)	

Dimensions in mm

PN	40						25			
	10	16	20	25	32	40	50	65	80	100
d4*	13	19	23	29	35	41	53	70	85	104
d1*	10	16	20	26	32	38	50	66	81	100
d5	Rd28x ¹ / ₈	Rd34x ¹ / ₈	Rd44x ¹ / ₈	Rd52x ¹ / ₈	Rd58x ¹ / ₈	Rd65x ¹ / ₈	Rd78x ¹ / ₈	Rd95x ¹ / ₈	Rd110x ¹ / ₈	Rd130x ¹ / ₈

* on request also with ISO pipe dimensions, see page 95

When ordering, please specify: connection fitting type, nominal diameter (DN), operating temperature, sealing ring material or medium, pressure.

6.4 Connection fittings

Connection fittings corrugated hoses

Type UA12S, type UA22S

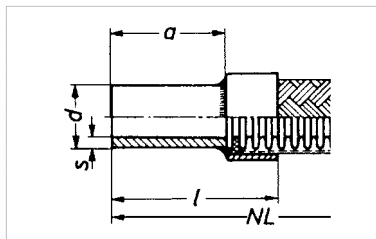

Pipe fittings
Welding end with
ISO pipe dimensions
Made of steel or stainless steel
1.4541 or 1.4571
Welded or brazed

Connection fitting type	Material	Permissible operating temperature
UA12S	Steel	480 °C
UA22S	Stainless steel	550 °C

Dimensions in mm, weight G in kg

PN	160				100		40										16	
	8	10	12	16	20	25	32	40	50	65	80	100	125	150	200	250	300	
d	10.0 ²⁾	13.5	17.2	21.3	26.9	33.7	42.4	48.3	60.3	76.1	88.9	114.3	139.7	168.3	219.1	273	323.9	
s	1.5 ²⁾	1.8 ¹⁾	1.8 ¹⁾	2	2.3	2.6	2.6	2.6	2.9	3.2	3.6	4	4.5	6.3	6.3	7.1		
a	50	55	55	60	60	65	65	70	70	75	80	85	85	90	100	100	120	
l	60	65	67	74	76	83	85	92	95	103	110	117	121	130	145	150	175	
G approx.	0.04	0.05	0.06	0.08	0.13	0.18	0.26	0.30	0.41	0.55	0.74	1.10	1.54	2.14	3.83	5.13	7.95	

¹⁾ with stainless steel: s = 1.6

²⁾ with steel 10.2 x 1.6

Material selection for steels: see chapter 7.2.

When ordering, please specify: connection fitting type, nominal diameter (DN), operating temperature, in case of stainless steel material no.

6.4 Connection fittings

Connection fittings corrugated hoses

Type UD12Q, type UD22Q

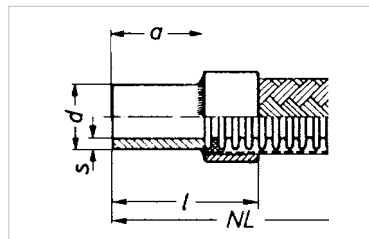

Pipe fittings
Precision pipe socket for tapping ring
fitting connection,
DIN EN ISO 8434-1 (series L)
made of steel or stainless steel
1.4541 or 1.4571
welded or brazed

Connection fitting type	Material	Permissible operating temperature
UD12Q	Steel	300 °C
UD22Q	Stainless steel	550 °C

Dimensions in mm, weight G in kg

PN	250					160		100		
	4*	6*	8*	10*	12*	16*	20*	25	32	40
d	6	8	10	12	15	18	22	28	35	42
s	1	1	1.5	1.5	2	1.5	2	2	2	3
a	28	28	30	30	32	32	36	40	45	45
l	36	36	40	40	44	46	52	58	65	67
G approx.	0.02	0.02	0.02	0.03	0.04	0.04	0.06	0.10	0.14	0.18

* Also suitable for Swagelok® threaded fittings for metric pipe dimensions. When ordering, please specify: connection fitting type, nominal diameter (DN), operating temperature, in case of stainless steel material no.

6.4 Connection fittings

Connection fittings corrugated hoses

Type WA22S, type WA32S

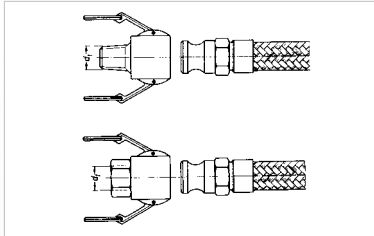

Quick release coupling

Lever arm coupling DIN EN 14420-7 with Whitworth pipe thread ISO 228/1 or Whitworth external thread DIN EN 10226 (ISO 7/1)

Made of brass or stainless steel
Welded or brazed

Connection fitting type	Material		Permissible operating pressure	Permissible operating temperature
	Quick release coupling	Sealing ring		
WA22S	Stainless steel	NBR (buna N)	16 bar	65 °C (NBR)
WA32S	Brass	FPM (Viton)		FPM on request

DN	20	25	32	40	50	65	80	100
d1 R/G	¾	1	1 ¼	1 ½	2	2 ½	3	4

6.4 Connection fittings

This quick release coupling stands out particularly through easy handling, quick mounting, robust design work and a long service life.

In order to complete the coupling process, the two halves of the coupling are put together and securely connected with each other by applying both cam levers. As there is compression of the inserted seals rather than a turning movement when coupling up, the connection can be completed without damaging the hose by twisting.

Applications

Lever arm couplings DIN EN 14420-7 are used to join hoses with connections for conveying liquids, solids and gases, except liquid gases and steam. Particular care is to be taken with the use of materials that are subject to the regulations on dangerous materials (Ordinance on Hazardous Substances – GefStoffV). The couplings can be used in a pressure range of -800 mbar to 16 bar in a working temperature range of -20 °C to +65 °C.

WARNING: Reduce the pressure in the pipeline before decoupling.

Please state the following when ordering: connection fitting, nominal diameter (DN), operating temperature, internal or external thread, sealing material or medium, pressure.

If only one half of the coupling is required (male or female part), this must be highlighted. Other DN upon request.

6.4 Connection fittings

Connection fittings corrugated hoses

Type WB12S, type WB22S, type WB52S

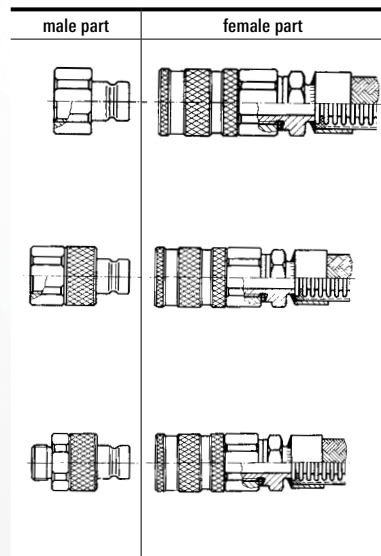

Version 1

Sealing coupling (female part) – self-sealing after decoupling plug nipple (male part) with internal thread – open passageway

Version 2

Sealing coupling (female part) – self-sealing after decoupling sealing nipple (male part) with internal thread – self-sealing after decoupling

Version 3

Sealing coupling (female part) – self-sealing after decoupling sealing nipple (male part) with external thread – self-sealing after decoupling

Quick disconnect coupler

Hose side connected with threaded connection, type MA ... (page 143)

consisting of sealing coupling (female part) and plug nipple (male part)

Thread: Whitworth pipe thread ISO 228/1

Connection fitting type	DN	Material	Permissible operating temperature
WB12S	30-100 bar	Zinc-plated steel	-50 to +200 °C Depending on sealing material and flow medium
WB22S	20-200 bar	Stainless steel	
WB52S	20-200 bar	Brass	

Nominal diameter: DN 4 to DN 50. PN to 400 bar, dependent on DN.

When ordering, please specify: connection fitting type, nominal diameter (DN), operating temperature, version for male part and/or female part, sealing material or medium, pressure. Other materials and other versions upon request.

6.4 Connection fittings

Connection fittings corrugated hoses

Type WC22S, type WC52S

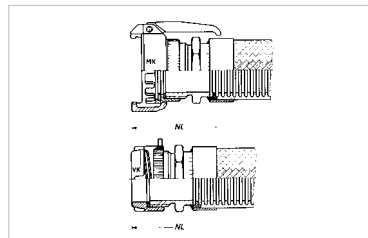

Quick release coupling for tank lorry DIN EN 14420-6

Connected on hose side

with threaded connection type MA ... (page 143)

consisting of swivelling female part

(MK coupling) with coupling levers or

fixed male part (VK coupling)

Both male part and female part can be mounted on the hose.

Connection: Whitworth pipe thread as per ISO 228/1

Connection fitting type	Material		Permissible operating temperature	
	Coupling	Sealing ring		
WC22S	Stainless steel	AU, EU (Vulkollan) NBR (buna N)	100 °C	
WC52S	Brass	FPM (Viton) CSM (Hypalon) or PTFE (Teflon)		
	DN	50	80	100
Designation for:				
male part		VK50	VK80	VK100
female part		MK50	MK80	MK100

When ordering, please specify: connection fitting type, operating temperature, nominal diameter designation for male part and/or female part, sealing material or medium, pressure. Higher temperatures upon request.

6.4 Connection fittings

Self-assembly connection fittings

Self-assembly connection fittings enable quick and cost-effective fitting of HYDRA metal hoses on building sites. The hoses are available as goods sold by the metre, cut to length on site and fitted with the appropriate connectors. The following connection fittings are suitable for self-assembly:

Hose type	Nominal diameter	Operating pressure	Operating pressure with HYDRA Quick screw connection
RS 341S00	DN 10 – DN 25 DN 32	20 bar 2.5 bar	6 bar 2.5 bar
RS 351S00 (on request)	DN 12 DN 16 DN 20 DN 25	18 bar 17 bar 9 bar 10 bar	6 bar
IX 331S00 (on request)	DN 12 DN 16 DN 20 DN 25	34 bar 18 bar 18 bar 16 bar	6 bar
RS 331S12	DN 6 – DN 50	16 bar	-

The fittings for hose types RS 341S00 and RS 331S12 are specified below. Information on self-assembly of RS 351 and of IX 331 is available on request.

The operating pressures of non-braided hoses are designed to avoid permanent expansion of more than 2%.

Metal hoses with connection fittings for self-assembly are not to be used with dynamic loads such as frequent movement, vibrations and shock pressure, hazardous media and heat transfer oils.

6.4 Connection fittings

Assembly instructions RS 341S00



1. Cut the hose to required length in the corrugation groove with a pipe cutter



2. Slip the union nut over hose



3. Open the clamping jaw after pulling back the striking pin. Place the corrugated hose with the second corrugation groove in the clamping jaw.



4. Close the clamping jaw. Use the striking pin to compress the ridge into a rim.



5. Press the burr inwards with the swaging.



6. Insert the clamping ring into the first corrugation groove and compress to form a closed ring. Insert the seal, place the male part in position and tighten with two spanners.

6.4 Connection fittings

Self-assembly connection fittings, RS 341S00

Type NA50S Removable threaded connection

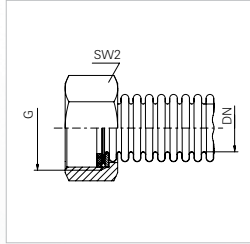

Type NA50S - union nut

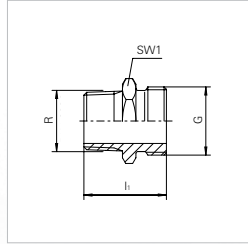

Type MA50S - external thread

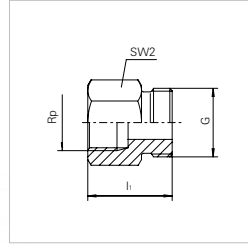

Type MA50S - internal thread

Set consists of: brass union nut, flush seal, stainless steel clamping ring, gasket (AFM 34)

DN	Type	Threaded connection set DIN EN ISO 228-1	WAF2	Weight approx.	Order number
-	-	-	mm	kg	-
10	NA50S	G ½	24	0.026	379144
12	NA50S	G ½	24	0.026	377093
16	NA50S	G ¾	30	0.036	377094
20	NA50S	G 1	38	0.076	377095
25	NA50S	G 1 ¼	46	0.097	377096
32*	NA50S	G 1 ½	55	0.152	377097

* can only be pre-assembled in factory

6.4 Connection fittings

Self-assembly connection fittings, RS 341S00

Type MA50S Removable threaded connection

Brass male part, external thread suitable for threaded connection, type NA50S

DN	Type	Male part external thread		l1	WAF1	Weight approx.	Order number
		DIN EN 10226-1	DIN EN ISO 228-1				
-	-	-	-	mm	mm	kg	-
10	MA50S	R ¾	G ¾	27.0	19	0.045	275486
12	MA50S	R ½	G ½	33.0	22	0.060	275487
16	MA50S	R ½	G ¾	34.0	27	0.070	284264
20	MA50S	R ¾	G 1	38.0	36	0.126	275489
25	MA50S	R 1	G 1 ¼	45.5	46	0.244	080142
32	MA50S	R 1 ¼	G 1 ½	48.0	50	0.298	086459

Brass male part, internal thread suitable for threaded connection, type NA50S

DN	Type	Male connector internal thread		l1	WAF2	Weight approx.	Order number
		DIN EN 10226-1	DIN EN ISO 228-1				
-	-	-	-	mm	mm	kg	-
10	MA50S	Rp ¾	G ¾	26.0	22	0.043	275491
12	MA50S	Rp ½	G ½	29.0	27	0.070	275495
16	MA50S	Rp ½	G ¾	29.0	27	0.075	275496
20	MA50S	Rp ¾	G 1	33.0	36	0.156	275497
25	MA50S	Rp 1	G 1 ¼	37.0	41	0.309	328006
32	MA50S	Rp 1 ¼	G 1 ½	42.0	50	0.31	315474

6.4 Connection fittings

Self-assembly fittings RS 341S00

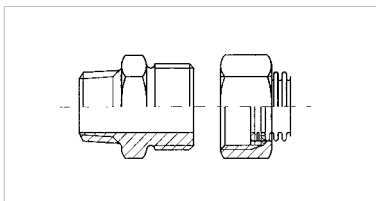

Fig. 1
Screw coupling
Male part with external thread.

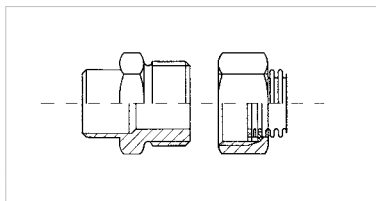

Fig. 2
Screw coupling male part with ISO welding end or connecting piece:
Precision socket type for cutting ring

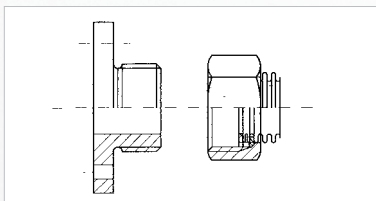

Fig. 3
Screw coupling
Male part with threaded flange
PN 20 1.4301.

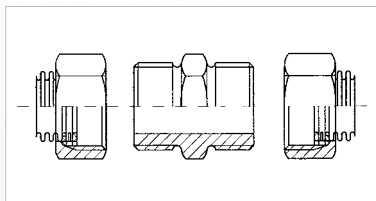

Fig. 4
Connection fittings:
- 1 double nipple
- 2 union nuts

Note:

All sets are supplied with the required number of clamping discs (one-piece) and gaskets (Graphit Sigraflex for VA or AFM 34 for brass).

6.4 Connection fittings

Screw coupling

DN	Screw coupling Fig. 1 Order number		Screw coupling Fig. 2 Order number		Screw coupling Fig. 3 Order number
-	Stainless steel 1.4301 RE20S	Brass RE50S	Welding end SS20S	Precision pipe SS20S	Stainless steel 1.4301/1.4541 KB20E
12	340 287	294 708	340 289	393 001	-
16	340 210	294 709	340 213	393 000	340 203
20	340 211	295 004	340 215	393 002	340 204
25	340 212	295 005	340 216	393 003	340 206

Connection fitting

DN	Connection fitting Fig. 4 Order number		Reducer Order number	
-	Stainless steel 1.4301 WN20S	Brass WN50S	DN -	Stainless steel 1.4301 WN20S
12	340 286	319 947	-	-
16	340 207	319 948	16/12	426 120
20	340 208	319 949	-	-
25	340 209	319 950	20/25	426 122

Dimensions for connectors

DN	Thread	Union nut Width across flats	Screw-in components External thread	Screw-in components Welding end	Precision socket type of connecting piece	Width across flats
-	-	WAF	-	mm	mm	WAF
12	G ½	24	R ½	17.2 x 1.8	12 x 1.5 x 32 15 x 2 x 32	22
16	G ¾	30	R ½	21.3 x 2.0	18 x 1.5 x 32	27
20	G 1	41	R ¾	26.9 x 2.3	22 x 2 x 36	36
25	G 1¼	46	R 1	33.7 x 2.6	28 x 2 x 40	46

Assembly instructions RS 331S12

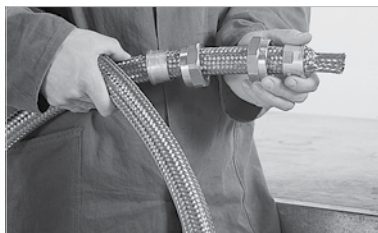

Push the insert and union nuts for both sides of the connection onto the braided hose. Measure the required length of hose and cut off the braiding at this point with a wire cutter.



Push back the braiding slightly and saw the annularly corrugated hose off to the required length in the groove of the corrugation at right angles to the hose axis. This is best performed on a fast-running, fine-toothed circular saw. Remove burrs as necessary.



Widen the braiding slightly at the end of the hose and insert the two halves of the hose ring between the third and fourth corrugation on the hose.



Push the insert forwards until it sits flush to the hose ring. At the same time, smooth out the braiding so that it fits uniformly over the whole length of the hose. Cut the ends of the braiding flush to the front of the hose ring with a wire cutter.

Assembly instructions RS 331S12



Clamp the hose to the intended surfaces in the bench vice (do not clamp to hose!). Lightly tap the three exposed corrugations of the hose with a hammer to attach to a gasket. Ideally, use a bolt that has a similar chamfer to the inside diameter of the hose.



Push the union nut over insert and clamp to bench vice. Attach screw-in part with inserted seal and tighten with a spanner without using excessive force. The union nut can be fully tightened once assembled with the pipework. Protect the hose assembly against excess torsion by holding it against the insert.

6.4 Connection fittings

Self-assembly fittings RS 331S12

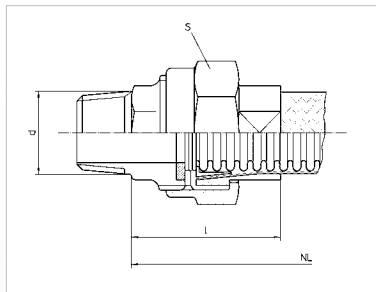

Type RE58W

Threaded coupling, external thread, brass, flat seal,
Set consists of screw-in part, union nut, insert, clamping ring and seal (AFM 34)

DN	Type	External thread d	Dimensions s	l	Weight approx. kg/component	Order number
-	-	DIN EN 10226-1	mm	mm		-
6	RE58W	R ¼	24	41	0.09	87542
8	RE58W	R ¼	27	43	0.10	87543
10	RE58W	R ⅜	30	47	0.11	87544
12	RE58W	R ½	32	55	0.15	87545
16	RE58W	R ½	41	59	0.25	87546
20	RE58W	R ¾	46	62	0.37	87547
25	RE58W	R 1	55	68	0.50	87548
32	RE58W	R 1¼	65	71	0.76	87549

Loose fittings are only suitable under certain conditions for low viscosity or aggressive media or high pressure applications and are not suitable for gas applications. Should these conditions prevail, please send us your enquiry with details of the load, temperature, pressure and working medium.

6.4 Connection fittings

Self-assembly fittings RS 331S12

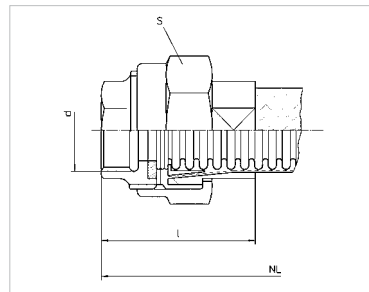

Type QA58W

Threaded coupling, brass internal thread, flat seal, *DN 40 - DN 50 made of free-cutting steel. Set consists of screw-in part, union nut, insert, clamping ring and seal (AFM 34)

DN	Type	External thread d	Dimensions s	l	Weight approx. kg/component	Order number
-	-	DIN EN 10226-1	mm	mm		-
6	QA58W	Rp ¼	24	31	0.08	87522
8	QA58W	Rp ¼	27	34	0.09	87523
10	QA58W	Rp ⅜	30	37	0.10	87524
12	QA58W	Rp ½	32	42	0.14	87525
16	QA58W	Rp ½	41	45	0.24	87526
20	QA58W	Rp ¾	46	46	0.31	87527
25	QA58W	Rp 1	55	50	0.42	87528
32	QA58W	Rp 1¼	65	52	0.59	87529
40*	QA18W	Rp 1½	75	64	0.75	87538
50*	QA18W	R 2	90	70	1.08	87539

Loose fittings are only suitable under certain conditions for low viscosity or aggressive media or high pressure applications and are not suitable for gas applications. Should these conditions prevail, please send us your enquiry with details of the load, temperature, pressure and working medium.

HYDRA double hose assembly, connection fittings on both ends

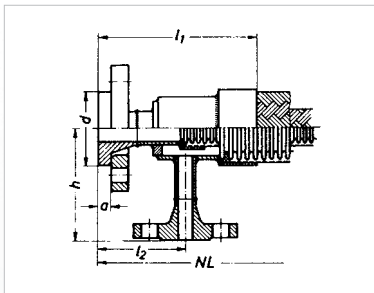

- Inner hose:
loose flange DIN PN 16 or 40
- Outer hose:
welding neck flange DIN PN 16 or 40 each welded

Connection fitting type	Material Flange inner hose	Flange outer hose	Permissible operating temperature	
			Inner hose	Outer hose
1AA1GG1	Steel	steel	300 °C	300 °C
1AA8GG1	Stainless steel 1.4541 or 1.4571	steel	450 °C	400 °C

With the 1AA8GG1 type, all the parts coming into contact with the medium of the inner hose are made of stainless steel

Dimensions in mm, weight G in kg

DN inner hose	10	16	20	25	32	40	50	65	80	100	150
DN outer hose	25	32	40	50	50	65	80	100	125	150	200
d fixed flange	10	10	15	15	15	15	20	20	20	20	25
d	40	45	58	68	78	88	102	122	138	158	212
a	10	10	12	12	12	12	14	14	16	16	18
l1	108	110	122	135	140	148	160	167	191	205	235
l2	65	65	75	80	80	80	90	90	100	100	115
h	90	95	95	100	105	110	125	135	145	160	195
G approx.	1.5	1.7	2.1	2.7	3.4	4.0	5.3	6.5	8.5	10.5	17.8

Choice of steel materials: see chapter 7.2

When ordering, please specify:

1. Nominal diameter (DN) of the piping, material no., nominal length (NL)
2. Type of connection fitting, material no.
3. Max. operating pressure, max. operating temperature
4. Flow medium for pipeline and coated pipeline
5. Mounting position and movement
6. Categorisation according to pressure device guidelines. Alternative connection fittings on request.

HYDRA double hose assembly, connection fittings on both ends

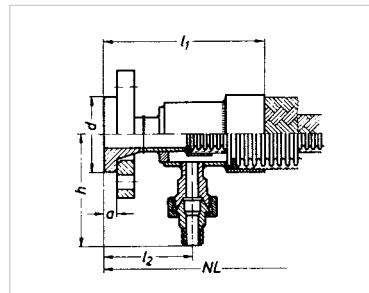

- Inner hose:
loose flange DIN PN 16 or 40, welded
- Outer hose:
threaded coupling male thread made of malleable iron, cone sealing, with Whitworth pipe thread DIN 2999 (ISO 7/1), brazed

Connection fitting type	Material Flange inner hose	Screw connection outer hose	Permissible operating temperature	
			Inner hose	Outer hose
1AA1RRO	Steel	Malleable iron	300 °C	300 °C
1AA8RRO	Stainless steel 1.4541 or 1.4571	Malleable iron	450 °C	300 °C

With type 1AA8RRO, all the components in contact with the medium in the piping are made of stainless steel

Dimensions in mm, weight G in kg

DN inner hose	10	16	20	25	32	40	50	65	80	100	150
DN outer hose	25	32	40	50	50	65	80	100	125	150	200
d threaded coupling	R 3/8	R 3/8	R 1/2	R 1/2	R 1/2	R 1/2	R 3/4	R 3/4	R 3/4	R 3/4	R 1
d	40	45	58	68	78	88	102	122	138	158	212
a	10	10	12	12	12	12	14	14	16	16	18
l1	108	110	122	135	140	148	160	167	191	205	235
l2	65	65	75	80	80	80	90	90	100	100	115
h	85	90	105	110	115	120	135	145	155	170	210
G approx.	1.1	1.3	1.7	2.3	3.0	3.5	4.7	5.8	7.8	9.7	17.0

When ordering, please specify:

1. nominal diameter (DN) of piping, material no., nominal length (NL)
2. type of connection fitting, material no.
3. max. operating pressure, max. operating temperature
4. flow medium for inner and outer coated pipelines
5. mounting situation and movement
6. classification according to pressure device guidelines. Alternative connection fittings on request.

6.5 HYDRA® annular corrugation hose assemblies

HYDRA insulating hose

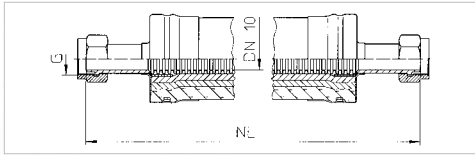

- Material annularly corrugated hose:
1.4404
- Material union nut:
1.4301 or similar
- Medium temperature:
max. 300 °C
- Operating pressure:
16 bar at 20 °C
8.5 bar at 300 °C
- Dimensions and connections:

DN	G	Permissible operating pressure at 20 °C	Outside diameter	Nominal length NL
-	-	P_{perm}	-	-
-	-	bar	mm	mm
10	M 16 x 1	16	40	500 1000 1500 2000

Different length and fittings on request

6.5 HYDRA® annular corrugation hose assemblies

PTFE-clad HYDRA hose assemblies

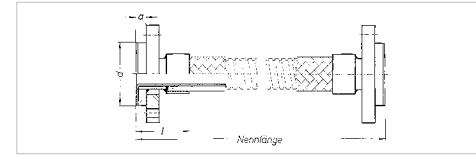

- Liner:
PTFE according to ASTM D 4895
Standard wall thickness 1.8 mm
optionally 3, 4 or 5 mm.
- Braiding and protective cover hose: 1.4301
- Media temperature: -40 °C to 230 °C
- Connections:
double-sided collar pipes with loose steel or stainless steel flanges

DN	d	a	l	Minimum bending radius	Permissible operating pressure at 20 °C	Permissible underpressure at 20 °C	Weight of hose	Connector weight	max. nominal length
-	-	-	-	r_{min}	P_{perm}	-	-	-	-
-	mm	mm	mm	mm	bar	bar	kg/m	kg	m
15	45	10	36	325	25	0.35	0.35	0.77	6
20	58	12	40	325	25	0.35	1.00	1.05	6
25	68	12	43	350	25	0.35	1.29	1.34	6
32	78	12	48	400	25	0.35	1.52	1.97	6
40	88	12	52	550	25	0.35	2.40	2.25	6
50	102	14	52	750	25	0.35	2.79	2.74	6
65	122	14	54	1000	20	0.5	4.80	3.70	6
80	138	16	70	1300	16	0.5	5.73	4.55	6
100	158	16	73	1500	12.5	0.7	8.06	5.17	6

HYDRA vibration absorber

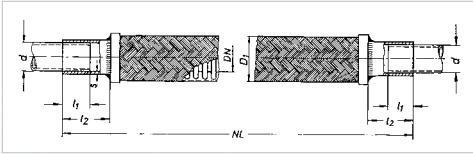

HYDRA vibration absorbers are primarily used in refrigeration engineering.

- DN 8 to DN 50:
annularly corrugated hose material 2.1010
braiding material 2.1016
- DN 65 to DN 100:
annularly corrugated hose material 1.4404 or 1.4541
braiding material 1.4301
- Media temperature:
-70 °C to 200 °C
- Frost proof
- Operating pressure:
30 bar at 20 °C
At a higher temperature, pressure is to be reduced according to table 6.1.1.
Safety factor against bursting $S > 3$
- Permissible vibration amplitudes:
 ± 1 mm in permanent use
 ± 5 mm at switching on/off
- Stability:
HYDRA vibration absorbers are resistant to common, non-corrosive refrigerants such as R134a or R502. Ammonia refrigerant NH_3 (R717) requires the use of stainless steel vibration absorbers.
- Dimensions and connections:
HYDRA compensation absorbers are available with connection ends in metric or in imperial dimensions. The internal braze ends are designed in such a way that they can be pushed directly onto copper pipes without additional braze fittings and connected using capillary brazing. They can optionally be supplied with extended internal braze ends.

- Versions available ex works:
 - VX 11 Connecting dimensions according to DIN 2856, standard braze ends
 - VX 12 Connecting dimensions according to DIN 2856, extended braze ends
 - VX 21 Connecting dimensions according to ASME/ANSI/B 16.22, standard braze ends
- Available short term by agreement:
 - VX 22 Connecting dimensions according to ASME/ANSI/B 16.22, extended braze ends
 - VX 31 Connecting dimensions according to DIN 2856, standard and extended braze ends
 - VX 33 Connecting dimensions according to ASME/ANSI/B 16.22, standard braze ends and extended braze ends
 - VX 41 Connecting dimensions according to DIN EN ISO 1127 D3/T3
- Label:
Trade mark, type, nominal pressure, year of manufacture, connection for outer pipe diameter

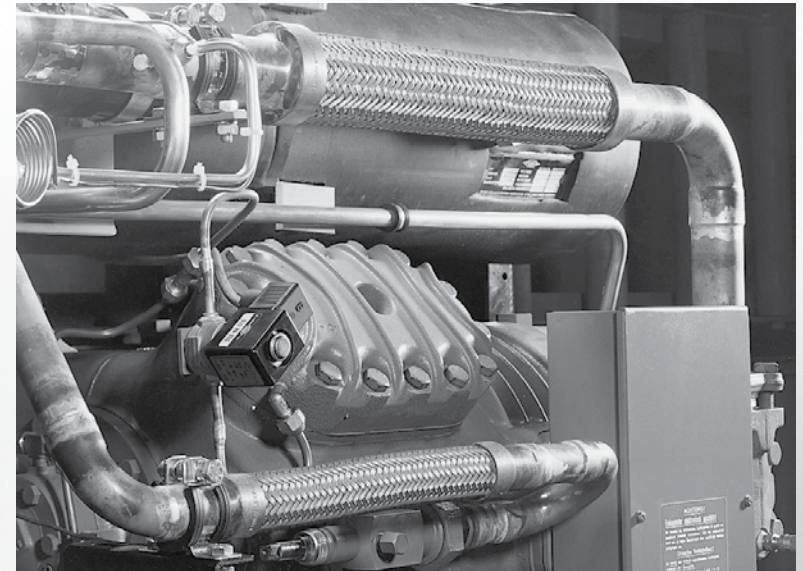

6.5 HYDRA® annular corrugation hose assemblies

HYDRA gas hose assemblies as per DIN 3384

Annularly corrugated hoses, ranges RS 331 S 00 and S 12, DN 6 to DN 150 are approved for nominal pressures up to a maximum of 16 bar according to DIN 3384. Dimensions, see chapter 6.3. The nominal pressure levels in accordance with DIN 3384 are detailed below. Only standard fittings approved according to DIN 3384 may be used for connecting the hose assembly to the gas supply.

6.5 HYDRA® annular corrugation hose assemblies

RS 321 narrow corrugation, highly flexible				RS 331/330/430 standard corrugation				RS 341 wide corrugation			
DN	Type	Connection technology		DN	Type	Connection technology		DN	Type	Connection technology	
		Welded	Brazed			Welded	Brazed			Welded	Brazed
–	–	PN	PN	–	–	PN	PN	–	–	PN	PN
6	RS 321L00	16	4	6	RS 331L00	16	4	6	RS 341L00	16	4
6	RS 321L12	16	4	6	RS 331L12	16	4	6	RS 341L12	16	4
8	RS 321L00	16	4	8	RS 331L00	16	4	8	RS 341L00	16	4
8	RS 321L12	16	4	8	RS 331L12	16	4	8	RS 341L12	16	4
10	RS 321L00	10	4	10	RS 331L00	16	4	10	RS 341L00	16	4
10	RS 321L12	16	4	10	RS 331L12	16	4	10	RS 341L12	16	4
12	RS 321L00	6	4	12	RS 331L00	10	4	12	RS 341L00	16	4
12	RS 321L12	16	4	12	RS 331L12	16	4	12	RS 341L12	16	4
16	RS 321L00	6	4	16	RS 331L00	6	4	16	RS 341L00	16	4
16	RS 321L12	16	4	16	RS 331L12	16	4	16	RS 341L12	16	4
20	RS 321L00	4	4	20	RS 331L00	4	4	20	RS 341L00	16	4
20	RS 321L12	16	4	20	RS 331L12	16	4	20	RS 341L12	16	4
25	RS 321L00	4	4	25	RS 331L00	4	4	25	RS 341L00	16	4
25	RS 321L12	16	5	25	RS 331L12	16	4	25	RS 341L12	16	4
32	RS 321L00	2,5	1	32	RS 331L00	2,5	1	32	RS 341L00	2,5	1
32	RS 321L12	16	1	32	RS 331L12	16	1	32	RS 341L12	16	1
40	RS 321L00	0,5	0,5	40	RS 331L00	2,5	1	40	RS 341L00	2,5	1
40	RS 321L12	16	1	40	RS 331L12	16	1	40	RS 341L12	16	1
50	RS 321L00	0,5	0,5	50	RS 331L00	0,5	0,5	50	RS 341L00	2,5	1
50	RS 321L12	16	1	50	RS 331L12	16	1	50	RS 341L12	16	1
				65	RS 331L00	0,5	0,5	65	RS 341L00	4	-
				65	RS 331L12	16	1	65	RS 341L12	16	-
				80	RS 331L00	0,5	0,5	80	RS 341L00	4	-
				80	RS 331L12	16	1	80	RS 341L12	16	-
				100	RS 331L00	0,5	0,5	100	RS 341L00	2,5	-
				100	RS 331L12	10	1	100	RS 341L12	16	-
				100	RS 430L22	16	-				
				125	RS 330L00	0,5	-				
				125	RS 330L12	6	-				
				125	RS 430L22	16	-				
				150	RS 330L00	0,5	-				
				150	RS 330L12	6	-				
				150	RS 430L92	16	-				

* The details in brackets apply to sealing connections in the thread.

Connection fittings

Type MH
02/12/22/52S
Hexagon nipple with
Whitworth external
thread
DIN EN 10226
(ISO 7/1)

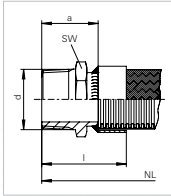

Type NF 12/22/52S
Ball type bushing
DIN 3863,
union nut with
Whitworth pipe
thread
ISO 228/1

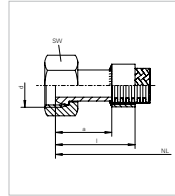

Type MH 32S
Hexagon nipple with
Whitworth external
thread
DIN EN 10226
(ISO 7/1)

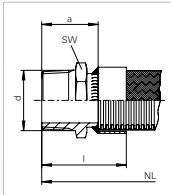

Type NN 12/22Q,
NN 12/22R
24° sealing cone
with O-ring,
union nut
DIN ISO 12151-2

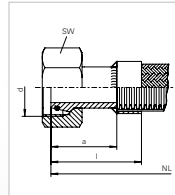

Type NA 12/22/52S
Collar pipe, flat
sealing,
union nut with
Whitworth pipe
thread
ISO 228/1

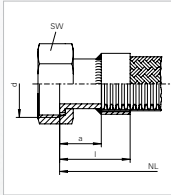

Type RF 02S/92S
Threaded fitting
conical sealing
with Whitworth
external thread
DIN EN 10226
(ISO 7/1)

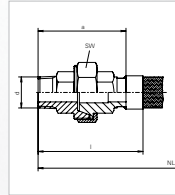

Type LA 12/22/52S
Hexagon socket
with
Whitworth internal
thread
DIN EN 10226
(ISO 7/1)

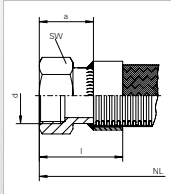

Type RF 12/22/52W
Threaded fitting
conical sealing
Whitworth
external thread
DIN EN 10226
(ISO 7/1)

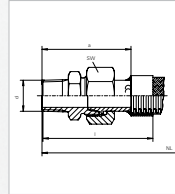

Connection fittings

Type QB
12/22/52W/92S
Threaded fitting
conical sealing
Whitworth internal
thread DIN EN 10226
(ISO 7/1)

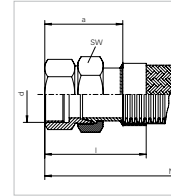

Type AB 12/82E
Flange connection,
swivelling
Welding collar,
loose flange

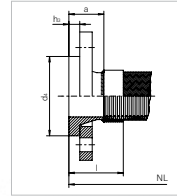

Type QA 02S
Threaded fitting
flat sealing
Whitworth internal
thread
DIN EN 10226
(ISO 7/1)

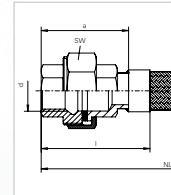

Type CA 82 E
CA 82/22
Flange connection,
swivelling
welding rim,
loose flange

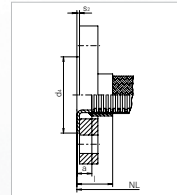

Type QB 02S/92S
Threaded fitting
conical sealing
Whitworth internal
thread
DIN EN 10226
(ISO 7/1)

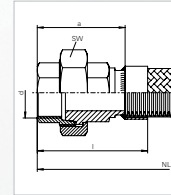

Type GB 12/22E
GB 12/22/82
Flange connection,
fixed

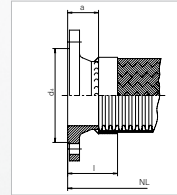

Type RE 02S/92S
Threaded fitting
flat sealing
Whitworth
external thread
DIN EN 10226
(ISO 7/1)

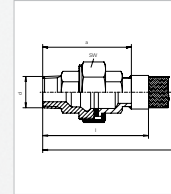

Type UA 12/22S,
UD 12/22Q
Welding end with
ISO pipe dimen-
sions

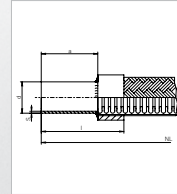

6.5 HYDRA® annular corrugation hose assemblies

HYDRA hose assemblies for presses

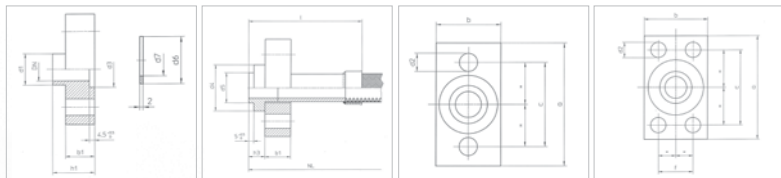

counter flange

DN 20-65

DN 80-100

Type BS16E – Rectangular flanged joint, swivelling

Collar pipes with projecting part and loose rectangular flange according to PN 16, made of steel, welded

DN	Collar pipes and loose rectangular flange PN 16									
	a	b	c	f	d2	b1	d4	d5	l	h3
-	mm	mm	mm	mm	mm	mm	mm	mm	mm	mm
20	95	50	65		14	25	45	29.4	110	16
25	105	70	75		14	30	55	36.4	119	16
32	125	70	85		18	30	60	45	135	16
40	130	90	95		18	30	72	56	146	16
50	160	100	115		22	40	85	68.3	171	18
65	190	120	135		26	40	100	88	220	18
80	200	150	145	90	22	40	135	106.5	234	20
100	250	180	180	110	30	60	160	131.5	254	22

6.5 HYDRA® annular corrugation hose assemblies

- Annularly corrugated hose from butt-welded pipe, hydraulically shaped
- Versions:
preferably RS 430 S22 with double braid and abrasion protection
- Maximum finished length:
DN 20 to DN 125 → 10 m
DN 150 to DN 300 → 3 m
Longer hose assemblies can be constructed out of sections on request.
- Standard materials:
annularly corrugated hose 1.4404 or 1.4541, braiding 1.4301
- Flanges:
a) standard flanges
b) rectangular flanges with the geometry described below

DN	Counter flange PN 16				Gasket		Hexagon bolts with washers and nuts		Weight of connectors approx.	
	d1	d3	h1	b1	d6	d7	Thread	Bolt length	Without counter flange	With counter flange
-	mm	mm	mm	mm	mm	mm		mm	kg	kg
20	26.9	31	36	25	30	20	M12	80	1.04	1.75
25	33.7	38	42	30	37	25	M12	90	1.90	3.28
32	42.4	47	42	30	46	32	M16	90	2.25	3.76
40	48.3	58	42	30	57	40	M16	90	2.90	4.98
50	60.3	70	52	40	69	50	M20	120	5.01	8.65
65	76.1	90	52	40	89	65	M24	120	7.01	12.10
80	88.9	109	52	40	108	80	M20	120	9.34	15.90
100	114.3	134	72	60	133	100	M27	180	19.20	33.40

HYDRA hose assemblies for presses

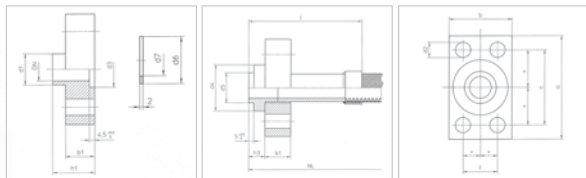

counter flange

Type BS16G – rotatable rectangular flanged joint

Collar pipes with projecting part and loose rectangular flange according to PN 25/40, made of steel, welded

DN	Collar pipes and loose rectangular flange PN 25/40									
	a	b	c	f	d2	b1	d4	d5	l	h3
-	mm	mm	mm	mm	mm	mm	mm	mm	mm	mm
20	95	50	65	25	11	25	45	29.4	110	16
25	105	70	75	40	14	30	55	36.4	119	16
32	125	70	85	35	18	35	60	45	135	16
40	125	90	85	50	18	40	72	56	146	16
50	150	100	105	55	22	50	85	68.3	171	18
65	175	120	125	65	26	60	100	88	220	18
80	210	150	150	90	30	60	135	106.5	234	20
100	250	180	180	110	36	80	160	131.5	254	22

DN	Counter flange PN 25/40				Gasket		Hexagon bolts with washers and nuts		Weight of connectors approx.	
	d1	d3	h1	b1	d6	d7	Thread	Bolt length	Without counter flange	With counter flange
-	mm	mm	mm	mm	mm	mm	-	mm	kg	kg
20	26.9	31	36	25	30	20	M10	80	1.03	1.73
25	33.7	38	42	30	37	25	M12	90	1.82	3.12
32	42.4	47	47	35	46	32	M16	110	2.37	4.0
40	48.3	58	52	40	57	40	M16	120	3.29	5.76
50	60.3	70	62	50	69	50	M20	140	5.24	9.11
65	76.1	90	72	60	89	65	M24	160	8.2	14.5
80	88.9	109	72	60	108	80	M27	180	12.7	22.7
100	114.3	134	94	80	133	100	M33	220	23.1	41.2

6.5 HYDRA® annular corrugation hose assemblies

Hydraflex HX 411 – hose assemblies for semi-flexible piping

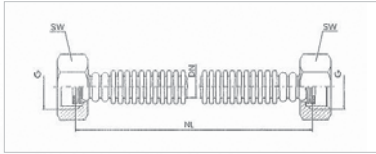

- Semi-flexible annularly corrugated hose without braiding, mechanically corrugated with flat-sealing brass union nuts
- Length tolerance:
NL ≤ 1000 mm: +15 mm / -10 mm
NL > 1000 mm: +1.5 % / -1.0 %
- Standard material: 1.4541

DN	Connection DIN-ISO 228/1	WAF1	Permissible operating pressure at 20°C	Minimum bending radius	Weight Approx.	Nominal length
-	-	-	P_{perm}	r_{min}	-	-
-	Inch	mm	bar	mm	kg/component	NL (mm)
10	G 3/8	19	21	18	0.050	300
					0.070	500
					0.10	800
					0.12	1000
12	G 1/2	24	21	20	0.070	300
					0.090	500
					0.12	800
					0.14	1000
16	G 3/4	30	16	25	0.12	300
					0.14	500
					0.20	800
					0.22	1000
20	G 1	38	10	30	0.20	300
					0.24	500
					0.29	800
					0.32	1000
25	G 1 1/3	46	10	35	0.36	500
					0.50	1000

6.5 HYDRA® annular corrugation hose assemblies

Hydraflex HX 711 – hose assemblies for semi-flexible pipework

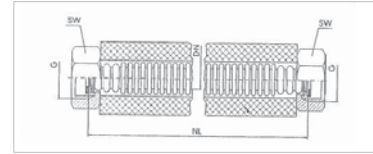

- Insulated semi-flexible annularly corrugated hose without braiding, mechanically corrugated with flat-sealing brass union nuts
- Length tolerance:
NL ≤ 1000 mm: +15 mm / -10 mm
NL > 1000 mm: +1.5 % / -1.0 %
- Standard material: 1.4541

DN	G DIN-ISO 228/1 connec- tion	WAF1	Permissible operating pressure at 20°C	Minimum bending radius	Weight Approx.	Nominal length
-	-	-	P_{perm}	r_{min}	-	-
-	Inch	mm	bar	mm	kg/component	NL (mm)
10	G 3/8	19	21	18	0.080	300
					0.10	500
					0.15	800
					0.18	1000
12	G 1/2	24	21	20	0.10	300
					0.13	500
					0.18	800
					0.21	1000
16	G 3/4	30	16	25	0.15	300
					0.20	500
					0.25	800
					0.30	1000
20	G 1	38	10	30	0.23	300
					0.30	500
					0.40	800
					0.45	1000
25	G 1 1/3	46	10	35	0.50	500
					1.00	1000

Protective hoses, type SG without coating

according to DIN EN ISO 15465 (type SOU), DIN EN 50086-2-3



Applications

- Protective hose type SG according to DIN EN ISO 15465 (type SOU)
- Standard protective hose for electrical installations with VDE approval according to DIN EN 50086-2-3
- Protective hose for rubber and plastic hoses

Characteristics

- Very flexible
- Tension-proof
- With high crushing strength

Design

- Stripwound metal hose
- Interlocked profile
- Round cross-section

Labelling

HYDRA AS < VDE > galvanised, without coating but with PG dimensions only

Materials

- Galvanised steel (1.0330) to DN 18
- Hot-dip galvanised steel (1.0226) from DN 20
- Brass (2.0321)
- Stainless steel (1.4301)

Versions

- Zinc-plated steel without coating
- Bright brass, nickel-plated or chromium-plated
- Stainless steel without coating

Operating temperature

- Brass: 250 °C
- Zinc-plated steel: 400 °C
- Stainless steel: 600 °C
(for VDE-approved applications: -15 °C to +60 °C)

Classification

Without coating

01-02-03-04-05-06-07-08-09-10-11-12
 --3--3--4--1--4--1--4--0--2--1--1--3
 (DN 8)
 --3--3--4--1--4--1--4--0--2--2--1--3
 (DN 11-51)

Production lengths

Measured in expanded position

- DN 3 to 11: 50 and 100 m collars
- DN 14 to 23: 25 and 50 m collars
- DN 31: 25 m collars

Supplied as follows

Bundled in rings

Types

- Protective hose, galvanised steel, type SG-S-O
- Protective hose, bright brass, type SG-M-O
- Protective hose, chromium-plated brass, type SG-M-C
- Protective hose, nickel-plated brass, type SG-M-N
- Protective hose, stainless steel, type SG-E-O

6.6 HYDRA® Stripwound hoses - fittings, hose assemblies

HYDRA protective hoses, type SG-S-O

according to DIN EN ISO 15465 (type SOU), DIN EN 61386-2-3

DN	Nominal size	Inside diameter	Outside diameter	Permissible deviation	Minimum bending radius	Weight approx.
-	PG	d	D	d, D	r_{\min}	-
-	DIN 40430	mm	mm	mm	mm	kg/m
3	-	3.0	4.6	± 0.2	18	0.028
4	-	4.0	5.8	± 0.2	19	0.035
5	-	5.0	6.8	± 0.2	20	0.045
6	-	6.0	8.0	± 0.3	21	0.050
7	-	7.1	9.1	± 0.3	23	0.060
8*	7	8.0	10.0	± 0.3	25	0.065
9	-	9.0	11.0	± 0.3	30	0.075
10	-	10.0	13.0	± 0.3	32	0.11
11*	9	11.0	14.0	± 0.3	34	0.12
12	-	12.0	15.0	± 0.3	36	0.13
13	-	13.0	16.0	± 0.3	40	0.14
14	-	13.5	16.5	± 0.3	40	0.135
14*	11	14.0	17.0	± 0.3	40	0.145
15	-	15.0	18.0	± 0.3	45	0.155
16*	13.5	16.0	19.0	± 0.3	45	0.165
17	-	17.0	20.0	± 0.3	50	0.175
18*	16	18.0	21.0	± 0.3	50	0.185
20	-	20.0	24.0	± 0.3	60	0.28
21	-	21.0	25.0	± 0.3	62	0.295
22	-	21.8	25.8	± 0.3	65	0.305
23*	21	23.0	27.0	± 0.3	67	0.32
25	-	25.0	29.0	± 0.3	75	0.345
28	-	28.0	32.0	± 0.3	80	0.385
29	-	29.2	34.2	± 0.4	85	0.415
30	-	30.0	35.0	± 0.4	85	0.43
31*	29	31.0	36.0	± 0.4	90	0.445
32	-	32.0	37.0	± 0.4	90	0.455
35	-	35.0	40.0	± 0.4	95	0.495

6.6 HYDRA® Stripwound hoses - fittings, hose assemblies

DN	Nominal size	Inside diameter	Outside diameter	Permissible deviation	Minimum bending radius	Weight approx.
-	PG	d	D	d, D	r_{\min}	-
-	DIN 40430	mm	mm	mm	mm	kg/m
36	-	36.0	41.0	± 0.4	100	0.51
37	-	37.0	42.0	± 0.4	105	0.53
38	-	38.2	43.2	± 0.4	105	0.54
40*	36	40.0	45.0	± 0.4	110	0.56
45	-	45.2	50.2	± 0.4	120	0.63
47*	42	47.0	52.0	± 0.4	125	0.66
48	-	48.0	53.0	± 0.5	125	0.67
49	-	49.2	54.2	± 0.5	125	0.68
50	-	50.0	55.0	± 0.5	125	0.70
51*	48	51.0	56.0	± 0.5	130	0.71

* Version according to VDE. Please provide the following information when ordering: type of hose, nominal diameter (DN), length

6.6 HYDRA® Stripwound hoses - fittings, hose assemblies

HYDRA protective hoses, type SG-M-C, SG-M-N

Nickel-plated or chromium-plated brass

DN	Inside diameter	Outside diameter	Permissible deviation	Minimum bending radius	Weight approx.
-	d	D	d, D	r _{min}	-
-	mm	mm	mm	mm	kg/m
3	2.4	3.8	± 0.2	15	0.030
3	2.6	3.0	± 0.2	15	0.030
3	3.0	4.5	± 0.2	15	0.031
3	3.2	4.7	± 0.2	15	0.032
4	3.5	5.0	± 0.2	15	0.033
4	4.0	6.0	± 0.2	20	0.044
5	5.0	7.0	± 0.2	20	0.050
6	6.0	8.0	± 0.2	20	0.056
7	7.0	9.0	± 0.2	20	0.074
8	8.0	9.0	± 0.2	25	0.084
9	9.0	11.0	± 0.2	25	0.105
10	10.0	13.0	± 0.3	25	0.104
12	11.5	14.0	± 0.3	30	0.103
12	12.0	15.0	± 0.3	30	0.115
13	13.0	16.0	± 0.3	35	0.119
14	14.0	17.4	± 0.3	35	0.148
15	15.0	18.0	± 0.3	40	0.157
16	16.0	19.2	± 0.3	40	0.205
17	17.0	20.0	± 0.3	45	0.218
18	18.0	21.3	± 0.3	45	0.238
19	19.0	22.0	± 0.3	45	0.268
20	20.0	23.0	± 0.3	50	0.282

* Version according to VDE. Please provide the following information when ordering: type of hose, nominal diameter (DN), length

6.6 HYDRA® Stripwound hoses - fittings, hose assemblies

HYDRA protective hoses, type SG-E-O

according to DIN EN ISO 15465 (type SOU), stainless steel

DN	Inside diameter	Outside diameter	Permissible deviation	Minimum bending radius	Weight approx.
-	d	D	d, D	r _{min}	-
-	mm	mm	mm	mm	kg/m
2	1.4	3.0	± 0.1	16	0.020
3	3.0	4.6	± 0.2	18	0.030
4	4.0	5.8	± 0.2	19	0.035
5	5.0	6.8	± 0.2	20	0.040
6	6.0	8.0	± 0.3	25	0.050
7	7.0	9.0	± 0.3	27	0.060
8	8.0	10.0	± 0.3	29	0.065
9	9.0	11.0	± 0.3	30	0.075
10	10.0	13.0	± 0.3	25	0.105
11	11.0	14.0	± 0.3	30	0.115
12	12.0	15.0	± 0.3	30	0.125
13	13.0	16.0	± 0.3	35	0.135
14	14.0	17.4	± 0.3	35	0.14
15	15.0	18.0	± 0.3	40	0.16
16	16.0	19.2	± 0.3	40	0.17
17	17.0	20.0	± 0.3	45	0.175
18	18.0	21.3	± 0.3	45	0.185
19	19.0	23.0	± 0.3	45	0.235
20	20.0	24.0	± 0.3	50	0.25
20	21.5	25.5	± 0.3	50	0.265
22	22.0	26.0	± 0.3	50	0.27
23	23.0	27.0	± 0.3	55	0.285
25	24.5	28.5	± 0.3	55	0.305
25	25.0	29.0	± 0.3	60	0.315
26	26.0	30.0	± 0.3	60	0.325
27	27.0	31.0	± 0.3	60	0.335
28	28.0	32.0	± 0.3	60	0.35

* Version according to VDE. Please provide the following information when ordering: type of hose, nominal diameter (DN), length

HYDRA protective hoses, type SG with PVC coating

according to DIN EN 61386-2-3 (VDE 0605 parts 2-3), galvanised steel with plastic coating

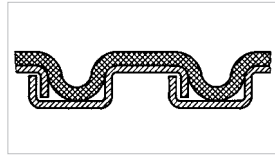

Applications

- Standard protective hose for electrical installations with VDE approval in accordance with DIN EN 61386-2-3
- Protective hose for rubber and plastic hoses

Characteristics

- Very flexible
- Tension-proof
- With high crushing strength
- Liquid-tight
- With PVC coating

Design

- Stripwound metal hose
- Interlocked profile
- Round cross-section

Labelling

HYDRA ASF < VDE > zinc-plated, with coating, but PG dimensions only

Materials

- Galvanised, zinc-plated steel (1.0330) up to DN 18
- Hot-dip galvanised steel (1.0226) from DN 20

Version

Galvanised steel, with black PVC coating

Operating temperature

Galvanised steel with PVC coating:
-20 °C to +80 °C
(for VDE-approved applications:
-15 °C to +60 °C)

Classification

With coating
01-02-03-04-05-06-07-08-09-10-11-12
--3--3--3--1--4--1--4--0--3--1--1--3
(DN 7)
--3--3--3--1--4--1--4--0--3--2--1--3
(DN 10-49)

Production lengths

Measured in expanded position

- DN 4 to 11: 50 and 100 m collars
- DN 14 to 23: 25 and 50 m collars
- DN 31: 25 m collars

Supplied as follows

Bundled in rings

Type

Protective hose, zinc-plated steel with black PVC coating, type SG-S-P

6.6 HYDRA® Stripwound hoses - fittings, hose assemblies

HYDRA protective hoses, type SG-S-P

according to DIN EN 61386-2-3 (VDE 0605 parts 2-3), galvanised steel with plastic coating

DN	Nominal size	Inside diameter	Outside diameter	Permissible deviation	Minimum bending radius	Weight approx.
-	PG	d	D	d, D	r _{min}	-
-	DIN 40430	mm	mm	mm	mm	kg/m
4	-	4.0	6.6	± 0.2	23	0.050
5	-	5.0	7.6	± 0.2	25	0.055
6	-	6.0	8.8	± 0.3	28	0.070
7*	7	7.1	9.9	± 0.3	30	0.075
8	-	8.0	10.8	± 0.3	34	0.085
9	-	9.0	11.8	± 0.3	38	0.095
10*	9	10.0	14.0	± 0.3	42	0.14
11	-	11.0	15.0	± 0.3	46	0.155
12	-	12.0	16.0	± 0.3	48	0.165
13*	11	13.0	17.0	± 0.3	51	0.175
14	-	13.5	17.5	± 0.3	51	0.185
14	-	14.0	18.2	± 0.3	53	0.195
15*	13.5	15.0	19.2	± 0.3	56	0.21
16	-	16.0	20.2	± 0.3	58	0.22
17*	16	17.0	21.2	± 0.3	60	0.235
18	-	18.0	22.2	± 0.3	64	0.245
20	-	20.0	25.4	± 0.3	69	0.37
21	-	21.0	26.4	± 0.3	74	0.385
22*	21	21.8	27.2	± 0.3	75	0.40
23	-	23.0	28.4	± 0.3	77	0.42
25	-	25.0	30.4	± 0.3	82	0.45
28	-	28.0	33.4	± 0.4	90	0.50
29*	29	29.2	35.8	± 0.4	93	0.56
30	-	30.0	36.6	± 0.4	96	0.58
31	-	31.0	37.6	± 0.4	98	0.60
32	-	32.0	38.6	± 0.4	101	0.615
35	-	35.0	41.6	± 0.4	109	0.665

6.6 HYDRA® Stripwound hoses - fittings, hose assemblies

DN	Nominal size	Inside diameter	Outside diameter	Permissible deviation	Minimum bending radius	Weight approx.
-	PG	d	D	d, D	r _{min}	-
-	DIN 40430	mm	mm	mm	mm	kg/m
36	-	36.0	42.6	± 0.4	112	0.685
38*	36*	38.2	44.8	± 0.4	117	0.73
40*	-	40.0	46.6	± 0.4	122	0.765
45*	42*	45.2	51.8	± 0.4	136	0.85
47	-	47.0	53.8	± 0.4	138	0.905
48	-	48.0	54.8	± 0.5	142	0.92
49*	48*	49.2	56.0	± 0.5	145	0.95
50	-	50.0	56.8	± 0.5	148	0.955
51	-	51.0	57.8	± 0.5	151	0.975

* Version according to VDE. Please provide the following information when ordering: type of hose, nominal diameter (DN), length

HYDRA protective hoses, type SD

Protective extraction and exhaust gas hoses

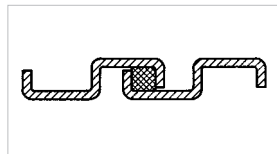

Application

Universal protective hose with gasket, also usable as extraction and exhaust gas hose

Characteristics

- Good flexibility
- Tension-proof
- With high crushing strength

Design

- Wound metal hose
- Interlocked profile
- Round cross-section

Materials

- Galvanised, zinc-plated steel (1.0330) up to DN 18
- Hot-dip galvanised steel (1.0226) from DN 20
- Stainless steel (1.4301)

Versions

- With rubber joint – G
- With cotton packing – B
- With ceramic seal – K

Operating temperature

- Zinc-plated with rubber joint: 60 °C
- Zinc-plated with cotton packing: 120 °C
- Zinc-plated with ceramic seal: 400 °C
- Stainless steel with ceramic seal: 600 °C

Production lengths

Measured in expanded position

- DN 8 to 11; 50 and 100 m collars
- DN 14 to 23; 25 and 50 m collars
- DN 31; 25 m collars

Supplied as follows

Bundled in rings

Types

- Extraction hose, zinc-plated steel, with cotton packing, type SD-S-B
- Extraction hose, zinc-plated steel, with rubber joint, type SD-S-G
- Extraction hose, zinc-plated steel, with ceramic seal, type SD-S-K
- Extraction hose, stainless steel, with ceramic seal, type SD-E-K

6.6 HYDRA® Stripwound hoses - fittings, hose assemblies

HYDRA protective hoses, type SD

Protective extraction and exhaust gas hoses, zinc-plated steel or stainless steel

DN	Inside diameter	Outside diameter	Permissible deviation	Minimum bending radius	Weight approx.
-	d	D	d, D	r _{min}	-
-	mm	mm	mm	mm	kg/m
3	3.0	5.0	± 0.2	40	0.060
4	4.0	6.0	± 0.2	40	0.070
5	5.0	7.0	± 0.2	40	0.085
6	6.0	8.0	± 0.2	35	0.095
7	7.0	9.0	± 0.2	35	0.105
8	8.0	10.0	± 0.2	40	0.115
9	9.0	11.0	± 0.2	40	0.14
10	10.0	13.0	± 0.2	45	0.18
11	10.5	13.0	± 0.2	45	0.19
11	11.0	14.0	± 0.2	55	0.20
12	12.0	15.0	± 0.2	55	0.21
13	13.0	16.0	± 0.2	60	0.215
14	14.0	17.4	± 0.2	60	0.22
15	15.0	18.0	± 0.2	70	0.24
16	16.0	18.7	± 0.2	70	0.26
16	16.0	19.2	± 0.2	70	0.265
17	17.0	20.0	± 0.2	80	0.28
18	18.0	21.3	± 0.2	80	0.29
19	19.0	23.0	± 0.3	80	0.315
20	20.0	24.0	± 0.3	90	0.335
22	21.5	25.5	± 0.3	90	0.37
23	23.0	27.0	± 0.3	95	0.395
25	24.5	28.5	± 0.3	95	0.415
25	25.0	29.0	± 0.3	105	0.43
26	26.0	30.0	± 0.4	105	0.46
30	30.0	34.0	± 0.4	110	0.525
31	30.5	34.5	± 0.4	110	0.54
32	31.5	35.7	± 0.4	120	0.57
32	32.0	36.0	± 0.4	120	0.58

6.6 HYDRA® Stripwound hoses - fittings, hose assemblies

DN	Inside diameter	Outside diameter	Permissible deviation	Minimum bending radius	Weight approx.
-	d	D	d,D	r _{min}	-
-	mm	mm	mm	mm	kg/m
34	34.0	38.5	± 0.4	125	0.585
35	35.0	39.5	± 0.4	130	0.60
36	36.0	41.5	± 0.4	130	0.64
37	37.0	42.5	± 0.4	140	0.68
38	38.0	43.5	± 0.4	145	0.72
39	38.5	44.0	± 0.4	145	0.76
40	40.0	45.0	± 0.4	150	0.83
41	40.5	45.7	± 0.4	150	0.95
44	44.0	49.5	± 0.4	170	1.010
45	45.0	50.5	± 0.4	175	1.030
47	46.5	52.5	± 0.4	180	1.070
48	48.0	53.5	± 0.5	190	1.10
50	50.0	56.0	± 0.5	200	1.16
52	52.0	58.0	± 0.5	210	1.30
53	53.0	59.0	± 0.5	220	1.35
55	55.0	61.0	± 0.5	250	1.40
60	60.0	66.0	± 0.6	260	1.59
65	65.0	72.0	± 0.6	270	1.95
70	70.0	77.0	± 0.6	280	2.10
75	75.0	82.0	± 0.6	290	2.25
80	80.0	87.0	± 0.6	300	2.40
90	90.0	100.0	± 0.7	315	2.62
100	100.0	110.5	± 0.7	330	2.85
110	110.0	120.5	± 0.7	360	3.11
120	120.0	131.5	± 0.7	400	3.40
125	125.0	136.5	± 0.7	400	3.45

When ordering, please specify: type of hose, nominal diameter (DN), length, choice of seal: cotton, rubber, ceramic or glass-fibre seals

HYDRA protective hose, type SV

Rectangular protective hoses

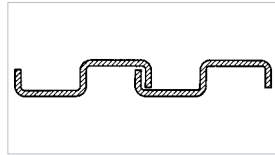

Application

Protective hose for energy guide chains, hydraulic lines and as conveyer hose

Characteristics

- Very flexible
- Tension-proof
- Resistant to transversal pressure

Design

- Wound metal hose
- Clamped profile
- Rectangular cross-section

Materials

Galvanised, zinc-plated steel (1.0333)

Versions

- Without gasket – O
- With rubber joint – G, on request
- With cotton packing – B, on request

Operating temperature

- With rubber joint: 60 °C
- With cotton packing: 120 °C
- Without seal: 400 °C

Production lengths

Up to max. 25 m

Supplied as follows

Bundled in rings

Types

- Rectangular protective hose, zinc-plated steel without seal, type SV-S-O
- Rectangular protective hose, zinc-plated steel with rubber joint, type SV-S-G
- Rectangular protective hose, zinc-plated steel with cotton packing, type SV-S-B

HYDRA protective hoses, type SV-S-O

Rectangular protective hoses, zinc-plated steel without sealing

Nominal size	Outside diameter		Inside diameter		Minimum bending radius		Weight approx.
	D ₁	D ₂	d ₁	d ₂	r _{min}	Permissible deviation	
NS							-
mm	mm	mm	mm	mm	mm	-	kg/m
15	30 x 50	± 1	27.0 x 47.0	± 1	70	-10	0.64
25	50 x 50	± 1	46.8 x 46.8	± 1	120	-10	0.82
38	45 x 85	± 1	40.8 x 81.0	± 1	100	-10	1.28
42	65 x 65	± 1	60.8 x 60.8	± 1	130	-10	1.26
51	60 x 85	± 1	55.8 x 81.0	± 1	130	-10	1.44
69	60 x 115	± 1	54.8 x 110.2	± 1	130	-20	2.37
92	80 x 115	± 1	74.6 x 110.0	± 1	170	-20	2.66
126	90 x 140	± 1	84.6 x 135.0	± 1	180	-20	3.15
140	80 x 175	± 1	74.4 x 169.8	± 1	170	-20	3.54
154	110 x 140	± 1	104.2 x 135.2	± 1	250	-20	3.60
193	110 x 175	± 1	104.2 x 169.6	± 1	250	-20	3.97
242	110 x 220	± 1.5	104.4 x 214.4	± 1.5	250	-20	4.60

When ordering, please specify: type of hose, nominal size (NG), length

HYDRA protective hoses, type SA

according to DIN EN ISO 15465



Application

- Protective hose according to DIN EN ISO15465 (Type DOU)
- Protective hose with high mechanical strength for light conductors, measuring lines and electric cables
- Protective hose for pressure hoses

Characteristics

- Resistant to torsion
- Flexible
- Tension-proof
- With high crushing strength

Design

- Wound metal hose
- Interlocked profile (Agraff profile)
- Round cross-section

Materials

- Galvanised, zinc-plated steel (1.0330) up to DN 18
- Hot-dip galvanised steel (1.0226) from DN 20
- Stainless steel (1.4301)

Versions

Stainless steel with PVC or silicone coating

Operating temperature

- Galvanised steel: 400 °C
- Stainless steel: 600 °C

Production lengths

Measured in expanded position

- Up to DN 9 max. 100 m,
From DN 10 max. 60 m
- From DN15 max. 50 m,
From DN 26 max. 40 m,
- From DN 45 max. 30 m,
From DN 65 max. 25 m

Supplied as follows

On reels or as a bundle

Types

- Protective hose, zinc-plated steel type SA-S-O
- Protective hose, stainless steel type SA-E-O

6.6 HYDRA® Stripwound hoses - fittings, hose assemblies

HYDRA protective hoses, type SA-S-O

according to DIN EN ISO 15465, zinc-plated steel without seal

DN	Inside diameter	Outside diameter	Permissible deviation		Minimum bending radius	Weight approx.
			d	D		
-	d	D	d	D	r _{min}	-
-	mm	mm	mm	mm	mm	kg/m
4	4.0	6.1	± 0.2	± 0.2	35	0.155
5	5.0	7.1	± 0.2	± 0.2	35	0.16
6	6.0	8.2	± 0.2	± 0.4	35	0.085
7	7.0	9.2	± 0.2	± 0.4	40	0.095
8	8.0	10.2	± 0.2	± 0.4	45	0.11
9	9.0	11.2	± 0.2	± 0.4	50	0.12
10	10.0	12.2	± 0.2	± 0.4	55	0.13
11	11.0	13.2	± 0.2	± 0.4	60	0.145
12	12.0	14.2	± 0.2	± 0.4	65	0.155
13	13.0	15.2	± 0.2	± 0.4	70	0.17
14	14.0	16.8	± 0.3	± 0.4	80	0.225
15	14.5	17.3	± 0.3	± 0.4	83	0.25
15	15.0	17.8	± 0.3	± 0.4	85	0.24
16	16.0	18.8	± 0.3	± 0.4	90	0.25
18	18.0	20.8	± 0.3	± 0.4	95	0.28
19	19.0	21.8	± 0.3	± 0.4	98	0.32
20	20.0	22.8	± 0.3	± 0.4	100	0.31
23	23.0	25.8	± 0.3	± 0.4	125	0.355
25	25.0	28.3	± 0.3	± 0.5	135	0.048
28	28.0	31.3	± 0.3	± 0.5	150	0.54
30	30.0	33.3	± 0.3	± 0.5	155	0.575
32	32.0	35.3	± 0.3	± 0.5	170	0.615
35	35.0	38.3	± 0.3	± 0.5	185	0.67
36	36.0	39.3	± 0.3	± 0.5	185	0.685

6.6 HYDRA® Stripwound hoses - fittings, hose assemblies

DN	Inside diameter	Outside diameter	Permissible deviation		Minimum bending radius	Weight approx.
			d	D		
-	d	D	d	D	r _{min}	-
-	mm	mm	mm	mm	mm	kg/m
40	40.0	44.4	± 0.4	± 0.6	210	0.935
45	45.0	49.4	± 0.4	± 0.6	240	1.10
50	50.0	54.4	± 0.4	± 0.6	260	1.16
54	54.0	58.4	± 0.4	± 0.6	270	1.30
55	55.0	59.4	± 0.4	± 0.6	270	1.33
60	60.0	66.0	± 0.4	± 0.6	310	1.87
65	65.0	71.0	± 0.6	± 0.6	315	2.020
70	70.0	76.0	± 0.6	± 0.6	325	2.18
75	75.0	81.0	± 0.6	± 0.6	345	2.34
80	80.0	86.0	± 0.6	± 0.6	370	2.50
85	85.0	91.0	± 0.6	± 0.6	385	2.65
90	90.0	98.0	± 0.8	± 0.6	400	2.80
100	100.0	108.0	± 0.8	± 0.6	440	3.12

Please provide the following information when ordering: type of hose, nominal diameter (DN), length

6.6 HYDRA® Stripwound hoses - fittings, hose assemblies

HYDRA protective hoses, type SA-E-O

according to DIN EN ISO 15465, stainless steel without gasket

DN	Inside diameter	Outside diameter	Permissible deviation		Minimum bending radius	Weight approx.
			d	D		
-	d	D	d	D	r _{min}	-
-	mm	mm	mm	mm	mm	kg/m
4	4.0	6.1	± 0.2	± 0.2	35	0.155
5	5.0	7.1	± 0.2	± 0.2	35	0.16
6	6.0	8.2	± 0.2	± 0.4	35	0.085
7	7.0	9.2	± 0.2	± 0.4	40	0.10
8	8.0	10.2	± 0.2	± 0.4	45	0.11
9	9.0	11.2	± 0.2	± 0.4	50	0.125
10	9.5	11.7	± 0.2	± 0.4	53	0.13
10	10.0	12.2	± 0.2	± 0.4	55	0.135
11	11.0	13.2	± 0.2	± 0.4	60	0.145
12	12.0	14.2	± 0.2	± 0.4	65	0.16
13	13.0	15.2	± 0.2	± 0.4	70	0.17
14	14.0	16.8	± 0.3	± 0.4	80	0.225
15	15.0	17.8	± 0.3	± 0.4	85	0.24
16	16.0	18.8	± 0.3	± 0.4	90	0.255
17	17.0	19.8	± 0.3	± 0.4	95	0.285
18	18.0	20.8	± 0.3	± 0.4	95	0.29
19	19.0	21.8	± 0.3	± 0.4	98	0.315
20	20.0	22.8	± 0.3	± 0.4	100	0.325
22	22.0	24.8	± 0.3	± 0.4	117	0.36
23	23.0	25.8	± 0.3	± 0.4	125	0.37
25	25.0	28.3	± 0.3	± 0.5	135	0.49
27	27.0	30.3	± 0.3	± 0.5	145	0.525
28	28.0	31.3	± 0.3	± 0.5	150	0.54
30	30.0	33.3	± 0.3	± 0.5	155	0.575

6.6 HYDRA® Stripwound hoses - fittings, hose assemblies

DN	Inside diameter	Outside diameter	Permissible deviation		Minimum bending radius	Weight approx.
			d	D		
-	d	D	d	D	r _{min}	-
-	mm	mm	mm	mm	mm	kg/m
32	32.0	35.3	± 0.3	± 0.5	170	0.615
33	33.0	36.3	± 0.3	± 0.5	175	0.635
35	35.0	38.3	± 0.3	± 0.5	185	0.675
40	40.0	44.4	± 0.4	± 0.6	210	0.95
45	45.0	49.4	± 0.5	± 0.6	240	1.10
50	50.0	54.4	± 0.4	± 0.6	260	1.17
54	54.0	58.4	± 0.4	± 0.6	270	1.31
55	55.0	59.4	± 0.4	± 0.6	270	1.33
58	58.0	62.4	± 0.4	± 0.6	272	1.83
60	60.0	66.0	± 0.6	± 0.6	200	1.87
65	65.0	71.0	± 0.6	± 0.6	210	2.025
70	70.0	76.0	± 0.6	± 0.6	240	2.18
75	75.0	81.0	± 0.6	± 0.6	260	2.34
80	80.0	86.0	± 0.6	± 0.6	270	2.50
85	85.0	91.0	± 0.6	± 0.6	290	2.65
90	90.0	98.0	± 0.6	± 0.8	300	2.80
100	100.0	108.0	± 0.6	± 0.8	340	3.12

* Version according to VDE. Please provide the following information when ordering: type of hose, nominal diameter (DN), length

HYDRA protective hoses, type SZ

Protective hoses for fibre optics

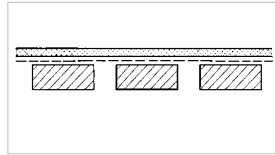

Application

Protective hose for light conductors in medical and industrial applications, e.g. endoscopy, measurement and control technology

Characteristics

- Highly flexible, with bending radius limitation
- High tensile strength and very slight elongation
- Resistant to torsion and transversal pressure
- Autoclavable, light- and liquid-fast
- Smooth interior surface – completely free of burrs

Design

- Flat wire spiral with fibre glass braiding and grey silicone coating (medical version)
- Round cross-section

Materials

- Stainless steel (1.4301)
- Aluminium (3.3555)

Operating temperature

-60 °C to +180 °C
for steam pressure sterilisation up to +134 °C

Production lengths

Measured in expanded position
d: 1.0 – 3.5 approx. 90% > 50 m,
rest > 15 m
4 – 8 approx. 80% > 40 m,
rest > 10 m
10 – 13 approx. 70% > 20 m,
rest > 7 m

Supplied as follows

On reels or as a bundle

Types

- Special protective hose for light conductors, stainless steel, type SZ 111S
- Special protective hose for light conductors, aluminium, type SZ 111S
- Special protective hose for light conductors, stainless steel, type SZ 211S, lightweight version

6.6 HYDRA® Stripwound hoses - fittings, hose assemblies

HYDRA protective hoses, type SZ 111S

Protective hoses for fibre optics

DN	Inside diameter		Outside diameter		Minimum bending radius	Weight approx.
	Perm. deviation		Perm. deviation			
-	d	d	D	D	r _{min}	-
-	mm	mm	mm	mm	mm	kg/m
1	1.0	- 0.15	2.9	+ 0.2/- 0.1	5	0.015
2	1.5	- 0.15	3.5	+ 0.2/- 0.1	6	0.019
3	2.5	- 0.15	4.4	+ 0.2/- 0.1	14	0.030
3	3.0	- 0.15	5.3	+ 0.2/- 0.1	20	0.045
4	3.5	- 0.15	5.8	+ 0.2/- 0.1	20	0.050
4	4.0	- 0.15	6.5	± 0.2	25	0.065
5	4.5	- 0.15	7.0	± 0.3	25	0.070
5	5.0	- 0.15	7.5	± 0.3	25	0.080
6	6.0	- 0.15	8.9	± 0.3	35	0.11
7	6.5	- 0.15	9.6	± 0.3	35	0.13
7	7.0	- 0.15	10.1	± 0.3	45	0.14
8	8.0	± 0.1	11.6	± 0.3	45	0.19
10	10.0	± 0.1	13.6	± 0.4	65	0.24
11	11.4	± 0.1	15.6	± 0.4	75	0.325
12	12.0	± 0.1	16.2	± 0.4	75	0.35

Special design manufactured from aluminium

DN	Inside diameter		Outside diameter		Minimum bending radius	Weight approx.
	Perm. deviation		Perm. deviation			
-	d	d	D	D	r _{min}	-
-	mm	mm	mm	mm	mm	kg/m
1	2.5	- 0.15	4.6	+ 0.2/- 0.1	15	0.018
2	4.0	± 0.15	6.5	± 0.3	25	0.028
3	4.6	± 0.15	7.1	± 0.3	25	0.036
12	6.0	± 0.15	8.9	± 0.3	35	0.058

When ordering, please specify: type of hose, material, nominal (DN), length

6.6 HYDRA® Stripwound hoses - fittings, hose assemblies

HYDRA protective hoses, type SZ 211S

Protective hoses DBP for fibre optics

DN	Inside diameter		Outside diameter		Minimum bending radius	Weight approx.
	Perm. deviation		Perm. deviation			
-	d	d	D	D	r _{min}	-
-	mm	mm	mm	mm	mm	kg/m
3	2.7	0.15	4.4	+ 0.2/- 0.1	7	0.020
3	3.3	0.15	5.3	+ 0.2/- 0.1	9	0.030
4	3.8	0.15	5.8	± 0.2	11	0.030
5	4.5	0.15	6.5	± 0.3	13	0.040
5	5.0	0.15	7.0	± 0.3	14	0.040
6	5.5	0.15	7.5	± 0.3	16	0.045
7	6.5	0.15	8.9	± 0.3	22	0.065
7	7.2	0.2	9.6	± 0.3	23	0.070
8	7.7	0.2	10.1	± 0.3	25	0.075
9	9.0	0.2	11.6	± 0.3	29	0.085
11	10.6	0.2	13.6	± 0.4	42	0.16
12	12.4	0.2	15.6	± 0.4	55	0.19
13	13.0	0.2	16.2	± 0.4	59	0.195

When ordering, please specify: type of hose, material, nominal diameter (DN), length

Special designs, type SA-E-S

Protective hoses for fibre optics

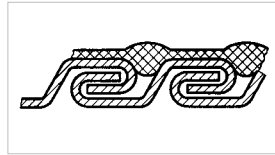

Applications

Protective hose for light conductors in medical and industrial applications, e.g. endoscopy, sensor technology, laser technology, optoelectronics, measurement and control technology

Characteristics

Resistant to torsion, particularly resistant to tension, flexible, light and liquid-fast with a high crushing strength

Design

- Stripwound metal hose
- Interlocked profile
- Round cross-section and grey silicon coating

Materials

Stainless steel (1.4301) with silicon coating

Operating temperature

-60 °C to +180 °C

Production lengths

Measured in expanded position

- Up to DN 9 max. 100 m, from DN 10 max. 60 m
- From DN 15 max. 50 m, from DN 26 max. 40 m
- From DN 45 max. 30 m, from DN 65 max. 25 m

Supplied as follows

On reels or as a bundle

DN	Inside diameter		Outside diameter		Minimum bending radius	Weight approx.
	d	perm. deviation	D	perm. deviation		
-	mm	mm	mm	mm	r _{min}	kg/m
5	4.8	± 0.2	8.5	± 0.4	35	0.112
6	5.8	± 0.2	9.5	± 0.4	45	0.144
6	6.0	± 0.2	9.6	± 0.4	43	0.115
7	7.0	± 0.2	10.6	± 0.4	48	0.131
8	8.0	± 0.2	11.6	± 0.4	55	0.146
9	9.0	± 0.2	12.6	± 0.4	60	0.162
10	10.0	± 0.2	13.6	± 0.4	66	0.176
11	11.0	± 0.2	14.6	± 0.4	73	0.192
12	12.0	± 0.2	15.6	± 0.4	78	0.208

Special designs type SA-E-O

Protective hoses for telephones, measurement devices, alarm systems

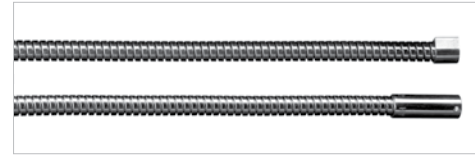

Protective hoses type SA-E-O

are manufactured to specific customer requirements. Some of these special designs are listed below.

Tensile strength

Specific customer requirements are crucial here too. Values > 2000 N are achievable.

DN	Inside diameter		Outside diameter		Minimum bending radius	Weight Approx.
	d	Perm. deviation	D	Perm. deviation		
-	mm	mm	mm	mm	r _{min}	kg/m
5	5.1	± 0.2	7.8	± 0.1	30	0.108
6	5.8	± 0.2	8.4	+ 0.1/- 0.2	35	0.115

Connection fittings type KLE 1, ERD 1, SUM

Compression coupling, earthing connection and counter nut for SG (VDE)/SG

Connection fitting KLE 1

Materials: Zinc-plated brass, connection thread DIN 40430, without grounding insert ERD 1, without counter nut SUM. Compression couplings can be used for the universal connection of protective hoses SG (VDE)* and SG.



KLE 1

Thread PG	Thread metric	Suitable for		Width across flats	Clamping sections	
		SG-S-O (VDE)	SG-P (VDE)		Outside diameter of hose	
-	-	DN	DN	s	min.	max.
DIN 40430	mm	-	-	mm	mm	mm
7	12 x 1.5	8	7	19	10.0	12.5
9	16 x 1.5	11	10	22	12.0	15.5
11	20 x 1.5	14	13	27	15.0	18.5
13.5	20 x 1.5	16	15	27	17.0	20.5
16	25 x 1.5	18	17	30	19.5	22.0
21	32 x 1.5	23	22	41	25.0	30.0
29	40 x 1.5	31	29	46	32.0	37.0
36	50 x 1.5	40	38	60	42.0	47.5
42	56 x 1.5	47	45	66	49.0	54.0
48	63 x 1.5	51	49	80	52.0	61.0

* VDE: When installed correctly with grounding insert, the screw connection fulfils the requirements of the VDE regulations. When ordering, please specify: Type, nominal size (PG)

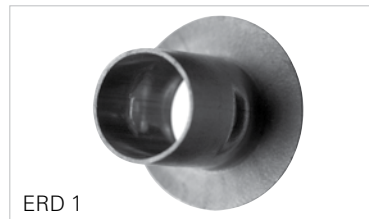

ERD 1



SUM

Nominal size PG	Suitable for	
	SG-S-O (VDE)	SG-S-P (VDE)
-	DN	DN
DIN 40430	-	-
7	8	7
9	11	10
11	14	13
13.5	16	15
16	18	17
21	23	22
29	31	29
36	40	38
42	47	45
48	51	49

Grounding insert ERD 1 bright brass and **counter nut SUM**

nickel-plated brass, compatible with compression coupling KLE 1

Connection fittings

Kroneck screw couplings GBGM

Materials

Nickel-plated brass

Kroneck screw couplings

- Ensure a metallic connection according to VDE 0113 providing they are used in accordance with these instructions.
- Are very space-saving and can therefore be mounted on terminal boxes with small hole separation.
- Can easily be released and used again several times.



Thread	1400 series		1600 series	
PG	Suitable for metal hoses SG and SD		Suitable for metal hose SG-S-P	
-	d ₁	d ₂	d ₁	d ₂
DIN 40430	mm	mm	mm	mm
7	8.0	x 10.2	7.0	x 10.2
9	11.0	x 14.0	10.0	x 14.0
11	14.0	x 17.4	13.0	x 17.4
13.5	16.0	x 19.2	15.0	x 19.2
16	18.0	x 21.3	17.0	x 21.3
21	23.0	x 27.0	21.5	x 27.0
29	31.5	x 35.7	30.0	x 35.7
36	40.5	x 45.7	38.5	x 45.7
42	46.5	x 52.5	44.0	x 52.5
48	50.0	x 56.0	48.0	x 56.0

Extraction, exhaust and conveying hoses

Type FA



Applications

Exhaust gas hose for mobile and stationary applications and can be used as extraction and conveying hose

Characteristics

- High mechanical stability
- Vibration-resistant
- Good flexibility
- Self-supporting bending behaviour
- For high temperatures, as metal-sealed

Design

- Stripwound metal hose
- Interlocked profile
- Polygonal cross-section

Materials

- Galvanised, zinc-plated steel (1.0330 / 1.0333)
- Stainless steel (1.4301)

Operating temperature

- Galvanised steel: 400 °C
- Stainless steel: 600 °C

Production lengths

In Stretched state

- Up to DN 55 max. 20 m
- From DN 60 max. 10 m

Supplied as follows

Bundled in rings

Types

- Exhaust gas hose, zinc-plated steel, type FA 330S
- Exhaust gas hose, stainless steel, type FA 330S

6.6 HYDRA® Stripwound hoses - fittings, hose assemblies

Extraction, exhaust and conveying hoses type FA 330S

Zinc-plated steel or stainless steel, metallic seal

DN	Inside diameter	Outside diameter	Permissible deviation	Minimum bending radius	Weight approx.
-	d	D	d, D	r _{min}	-
-	mm	mm	-	mm	kg/m
20	20.0	22.5	± 0.4	135	0.318
23	23.0	25.5	± 0.4	155	0.363
25	25.0	27.5	± 0.4	165	0.394
28	28.0	30.5	± 0.4	185	0.439
30	30.0	33.1	± 0.4	180	0.582
32	32.0	35.1	± 0.4	195	0.619
35	35.0	38.1	± 0.4	210	0.674
38	38.0	41.0	± 0.4	230	0.728
40	40.0	43.1	± 0.5	240	0.766
42	42.0	45.1	± 0.5	250	0.799
45	45.0	48.1	± 0.5	270	0.859
50	50.0	53.1	± 0.5	300	0.963
55	55.0	58.1	± 0.5	325	1.04
60	60.0	64.0	± 0.6	335	1.55
65	65.0	69.0	± 0.6	360	1.67
70	70.0	74.0	± 0.6	390	1.80
75	75.0	79.0	± 0.6	415	1.92
80	80.0	84.0	± 0.7	440	2.04
84	84.0	88.0	± 0.7	460	2.10
90	90.0	94.0	± 0.7	495	2.30
100	100.0	104.0	± 0.8	550	2.55
110	110.0	115.0	± 0.8	605	2.81
120	120.0	125.0	± 0.8	660	3.06
125	125.0	130.0	± 0.8	685	3.18

6.6 HYDRA® Stripwound hoses - fittings, hose assemblies

Extraction, exhaust and conveying hoses type FA 330S

Zinc-plated steel or stainless steel, metallic seal

DN	Inside diameter	Outside diameter	Permissible deviation	Minimum bending radius	Weight approx.
-	d	D	d, D	r _{min}	-
-	mm	mm	-	mm	kg/m
130	130.0	137.0	± 1.0	600	4.05
140	140.0	147.0	± 1.0	645	4.34
150	150.0	157.0	± 1.0	690	4.65
160	160.0	167.0	± 1.0	735	4.96
175	175.0	182.0	± 1.0	800	5.42
180	180.0	187.0	± 1.0	825	5.56
185	185.0	192.0	± 1.0	995	5.70
200	200.0	208.0	± 1.5	1085	7.74
225	225.0	233.0	± 1.5	1215	8.68
250	250.0	258.0	± 1.5	1350	9.60
275	275.0	283.0	± 1.5	1480	10.59
300	300.0	308.0	± 2.0	1615	11.49

When ordering, please specify: type of hose, material, nominal diameter (DN), length

Extraction, exhaust and conveying hoses

Type FG

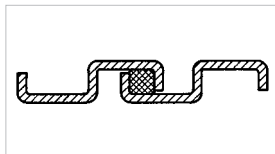
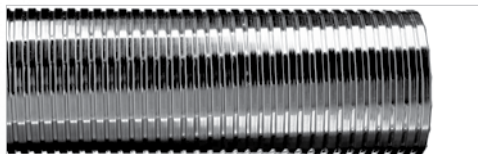

Application

Universal ventilation, extraction and conveying hoses, e.g. for smoke, shavings and exhaust gas

Characteristics

- Flexible
- Resistant to torsion

Design

- Stripwound metal hose
- Interlocked profile
- Polyagonal cross-section

Materials

- Steel, hot-dip galvanised (1.0226)
- Stainless steel (1.4301)

Versions

- Without gasket – O
- With rubber joint – G
- With cotton packing – B
- With ceramic seal – K

Operating temperature

- Zinc-plated with rubber joint: 60 °C
- Zinc-plated with cotton packing: 120 °C
- Zinc-plated with ceramic seal: 400 °C
- Stainless steel with ceramic seal: 600 °C

Production lengths

In stretched state

- To DN 180 max. 25 m
- From DN 200 max. 20 m
- From DN 350 max. 8 m

Supplied as follows

Bundled in rings

Types

- Extraction hose, zinc-plated steel, without seal
type FG-S-O
- Extraction hose, zinc-plated steel, with cotton packing
type FG-S-B
- Extraction hose, zinc-plated steel, with rubber joint
type FG-S-G
- Extraction hose, zinc-plated steel, with ceramic seal
type FG-S-K
- Extraction hose, stainless steel, with ceramic seal
type FG-E-K

6.6 HYDRA® Stripwound hoses - fittings, hose assemblies

Extraction, exhaust and conveying hoses

type FG-S-O, FG-S-G, FG-S-B, FG-S-K, FG-E-K

Zinc-plated steel or stainless steel with choice of seals

DN	Inside diameter	Outside diameter	Permissible deviation		Minimum bending radius	Weight approx.
			d	D		
-	d	D	d	D	r _{min}	-
-	mm	mm	mm	mm	mm	kg/m
20	20.0	24.0	± 0.3	± 0.5	100	0.35
25	25.0	29.0	± 0.3	± 0.5	110	0.43
30	30.0	34.0	± 0.4	± 0.6	130	0.51
32	32.0	36.0	± 0.4	± 0.6	140	0.545
35	35.0	39.0	± 0.4	± 0.6	150	0.59
38	38.0	42.0	± 0.4	± 0.6	155	0.645
40	40.0	44.5	± 0.4	± 0.5	155	0.675
45	45.0	49.5	± 0.4	± 0.5	165	0.755
50	50.0	54.5	± 0.5	± 0.6	180	0.835
60	60.0	65.5	± 0.5	± 0.8	215	1.01
63	63.0	68.5	± 0.6	± 1.0	225	1.06
65	65.0	70.5	± 0.6	± 1.0	230	1.09
70	70.0	75.5	± 0.6	± 1.0	240	1.17
71	71.0	76.5	± 0.6	± 1.0	245	1.19
75	75.0	80.5	± 0.6	± 1.0	255	1.25
80	80.0	85.5	± 0.8	± 1.2	270	1.34
81	81.0	87.0	± 0.8	± 1.2	275	1.36
85	85.0	90.5	± 0.8	± 1.2	275	1.42
90	90.0	97.0	± 0.8	± 1.2	280	1.85
100	100.0	107.0	± 0.8	± 1.2	300	2.04
102	102.0	109.0	± 0.8	± 1.2	300	2.08
110	110.0	117.0	± 0.8	± 1.2	330	2.24
112	112.0	119.0	± 0.8	± 1.2	340	2.28

When ordering, please specify: type of hose, material, nominal diameter (DN), length

6.6 HYDRA® Stripwound hoses - fittings, hose assemblies

Extraction, exhaust and conveying hoses

type FG-S-O, FG-S-G, FG-S-B, FG-S-K, FG-E-K

Zinc-plated steel or stainless steel with choice of seals

DN	Inside diameter	Outside diameter	Permissible deviation		Minimum bending radius	Weight approx.
			d	D		
-	d	D	d	D	r _{min}	-
-	mm	mm	-	-	mm	kg/m
120	120.0	127.0	± 0.8	± 1.2	380	2.44
122	122.0	129.5	± 0.8	± 1.2	390	2.49
125	125.0	132.0	± 0.8	± 1.2	400	2.54
130	130.0	138.5	± 1.0	± 1.5	410	2.92
140	140.0	148.5	± 1.0	± 1.5	430	3.13
150	150.0	158.5	± 1.0	± 1.5	460	3.35
160	160.0	168.5	± 1.0	± 1.5	490	3.57
175	175.0	184.0	± 1.0	± 1.5	530	3.90
180	180.0	189.0	± 1.0	± 1.5	540	4.01
200	200.0	210.5	± 1.5	± 2.0	560	5.51
210	210.0	220.5	± 1.5	± 2.0	585	5.78
224	224.0	234.5	± 1.5	± 2.0	625	6.15
225	225.0	235.5	± 1.5	± 2.0	630	6.18
250	250.0	260.5	± 1.5	± 2.0	700	6.85
275	275.0	285.5	± 1.5	± 2.0	770	7.52
280	280.0	291.0	± 1.5	± 2.0	800	7.66
300	300.0	311.0	± 2.0	± 2.5	850	8.20
315	315.0	326.0	± 2.0	± 2.5	890	8.60
350	350.0	367.5	± 2.0	± 2.5	1420	14.0
355	355.0	327.5	± 2.0	± 2.5	1440	14.2
400	400.0	417.5	± 3.0	± 3.5	1620	16.0
450	450.0	467.5	± 3.0	± 3.5	1820	17.9
500	500.0	517.5	± 3.0	± 3.5	2020	19.9

Larger nominal diameters on request

When ordering, please specify: type of hose, material, nominal diameter (DN), length

Extraction, exhaust and conveying hoses

Type FS with inner abrasion protection

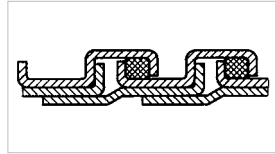
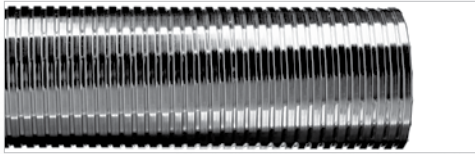

Applications

Conveying hose with smooth passageway, e.g. for granules, grain and abrasive materials

Characteristics

- Flexible
- Resistant to torsion
- Low wear and tear,
- Good tightness

Design

- Stripwound metal hose
- Interlocked profile
- Polygonal cross-section
- With inserted coil as abrasion protection

Materials

- Hot-dip galvanised steel (1.0226)
- Stainless steel (1.4301)

Versions

- Also available on request in combination of zinc-plated steel with interior coil made of stainless steel
- With rubber joint – G
- With cotton packing – B
- With ceramic seal – K

Operating temperature

- Zinc-plated with rubber joint: 60 °C
- Zinc-plated with cotton packing: 120 °C
- Zinc-plated with ceramic seal: 400 °C
- Stainless steel with ceramic seal: 600 °C

Manufacturing length

In stretched state

- To DN 180 max. 25 m
- From DN 200 max. 20 m
- From DN 350 max. 8 m
- Special lengths on request

Supplied as follows

Bundled in rings

Types

- Conveying hose, zinc-plated steel, with rubber joint type FS-S-G
- Conveying hose, zinc-plated steel, with cotton packing type FS-S-B
- Conveying hose, zinc-plated steel, with ceramic seal type FS-S-K
- Conveying hose, stainless steel, with ceramic seal type FS-E-K

6.6 HYDRA® Stripwound hoses - fittings, hose assemblies

Conveying hoses type FS-S-G, FS-S-B, FS-S-K, FS-E-K

With inner abrasion protection, zinc-plated steel or stainless steel

Inside diameter	Outside diameter	Permissible deviation	Bending radius $\pm 20\%$	Weight $\pm 10\%$		
				with cotton packing	with ceramic seal	with latex thread seal
d_1	D_2	-	-	kg/m	kg/m	kg/m
45	53.5	± 0.5	200	2.030	2.070	2.060
50	58.5	± 0.5	215	2.255	2.30	2.29
55	63.5	± 0.5	230	2.48	2.53	2.52
60	68.5	± 0.5	240	2.705	2.76	2.75
65	73.5	± 0.7	250	2.92	2.98	2.97
70	78.5	± 0.7	260	3.155	3.22	3.205
75	83.5	± 0.7	275	3.36	3.43	3.415
80	89.0	± 0.7	285	3.595	3.67	3.655
90	99.5	± 1.0	345	4.23	4.28	4.39
100	109.5	± 1.0	380	4.70	4.75	4.87
105	114.5	± 1.0	400	4.88	4.97	4.915
110	120.0	± 1.0	410	5.26	5.32	5.45
120	130.0	± 1.0	450	5.64	5.71	5.85
125	135.0	± 1.0	470	6.080	6.16	6.10
130	140.0	± 1.0	485	6.11	6.18	6.35
140	150.0	± 1.0	515	6.58	6.66	6.84
150	162.5	± 1.5	545	6.96	7.16	7.46
160	172.5	± 1.5	570	7.39	7.60	7.91
170	182.5	± 1.5	590	7.84	8.060	8.39
180	192.5	± 1.5	620	8.30	8.54	8.90
190	202.5	± 1.5	650	8.77	9.020	9.40
200	212.5	± 1.5	680	9.23	9.49	9.89
210	223.0	± 1.5	715	9.69	9.97	10.38

6.6 HYDRA® Stripwound hoses - fittings, hose assemblies

Conveying hoses type FS-S-G, FS-S-B, FS-S-K, FS-E-K

With inner abrasion protection, zinc-plated steel or stainless steel

Inside diameter	Outside diameter	Permissible deviation	Bending radius $\pm 20\%$	Weight $\pm 10\%$		
				with cotton packing	with ceramic seal	with latex thread seal
d_1	D_2	-	-	kg/m	kg/m	kg/m
225	238.0	± 1.5	765	10.40	10.70	11.15
250	265.0	± 2.0	880	15.47	15.68	16.33
275	290.0	± 2.0	1010	17.030	17.26	17.98
280	295.0	± 2.0	1040	17.34	17.57	18.34
300	315.0	± 2.0	1145	18.59	18.84	19.64
310	325.0	± 2.0	1200	19.21	19.46	20.27
350	365.0	± 2.0	1410	21.73	22.020	22.94
380	395.0	± 2.0	1565	23.58	23.90	24.93
400	415.0	± 2.0	1670	24.88	25.21	26.26
450	470.0	± 2.0	1930	28.010	28.42	29.60

When ordering, please specify: type of hose, material, nominal diameter (DN), length
With choice of seal

Special designs type SD370L, FG370L

Exhaust gas hoses DIN 14572

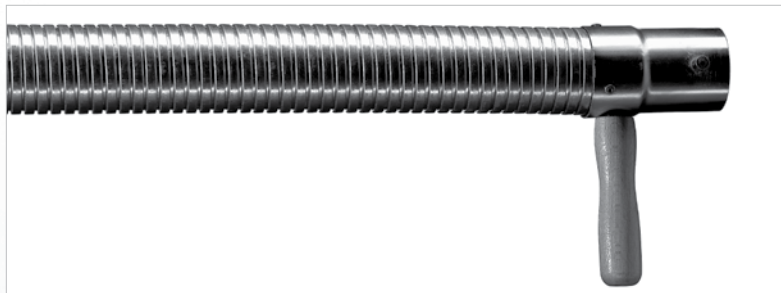

Applications

Exhaust gas hoses DIN 14572 are designed to convey exhaust gas from portable fire pumps (DIN 14410), from fire service vehicles (DIN 14502 part 1) and from power generating aggregates (DIN 14685).

The hoses prevent operating personnel being hindered or irritated by exhaust gases.

Design

- Round or polygonal cross-section
- Wooden handle bars
- Sleeve with pin on one side, sleeve with L-slot on the other

Materials

- Zinc-plated steel with glass fibre seal
- Hot-dip galvanised steel (1.0226) from DN 20

Operating temperature

400 °C

Delivery

Ex warehouse, prior sale reserved

Order text

Zinc-plated steel
 DN 47: type SD370L
 DN 80, 100 and 125: type FG370L

Special designs type SD370L, FG370L

Exhaust gas hoses DIN 14572

DN	Inside diameter	Outside diameter	Nominal length stretched	Weight
-	d1	d2	NL	-
-	mm	mm	mm	kg/m
47	50	52	1500 2500	2.50 4.00
80	85	87	2500	6.50
100	102	104	2500	10.00
125	130	132	2500	11.50

When ordering, please specify: type of hose, nominal diameter (DN), nominal length (NL).

Other dimensions on request.

6.6 HYDRA® Stripwound hoses - fittings, hose assemblies

Connection fittings type VA20S

For extraction, exhaust and conveying hoses type FA, FG, FS, SD

Design

Cylindrical sleeve

Mounting technique

Sealed and riveted, brazed and clamped

Materials

Stainless steel (1.4301)

Operating temperature

600 °C

Order text

Connection fitting type VA20S

DN	d mm	s mm	a mm	l mm	Weight approx. kg
40	40	1.0	50	80	0.09
50	50	1.0	70	100	0.13
60	60	1.0	70	110	0.18
70	70	1.0	80	120	0.22
80	80	1.0	80	120	0.25
100	100	1.0	100	150	0.39
120	120	1.0	100	150	0.46
125	125	1.0	100	150	0.48
150	150	1.0	100	160	0.77
180	180	1.0	120	180	1.03
200	200	1.0	140	210	1.33
250	250	1.0	180	250	1.97
300	300	1.0	200	280	3.18
315	315	1.0	200	280	3.33
350	350	1.0	200	290	3.84

When ordering, please specify: connection fitting type, nominal diameter (DN), mounting technique. Other dimensions upon request.

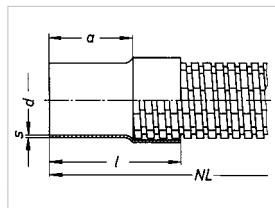

6.6 HYDRA® Stripwound hoses - fittings, hose assemblies

Connection fittings type VB20S

For extraction, exhaust and conveying hoses type FA, FG, FS, SD

Design

Sleeve with 2 slots, cylindrical

Mounting technique

Sealed and riveted, brazed or clamped

Materials

Stainless steel (1.4301)

Operating temperature

600 °C

Order text

Connection fitting type VB20S

DN	d mm	s mm	b mm	t mm	a mm	l mm	Weight approx. kg
40	40	1.0	3	30	50	80	0.09
50	50	1.0	3	40	70	100	0.13
60	60	1.0	3	40	70	110	0.18
70	70	1.0	3	40	80	120	0.22
80	80	1.0	3	40	80	120	0.25
100	100	1.0	3	50	100	150	0.39
120	120	1.0	3	50	100	150	0.46
125	125	1.0	3	50	100	150	0.48
150	150	1.0	3	55	100	160	0.77
180	180	1.0	3	60	120	180	1.03
200	200	1.0	3	70	140	210	1.33
250	250	1.0	3	80	180	250	1.97
300	300	1.0	3	80	200	280	3.18
315	315	1.0	3	80	200	280	3.33
350	350	1.0	3	80	200	290	3.84

When ordering, please specify: connection fitting type, nominal diameter (DN), mounting technique. Other dimensions upon request.

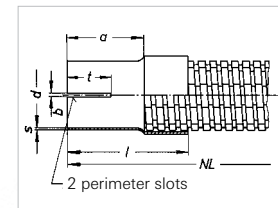

6.6 HYDRA® Stripwound hoses - fittings, hose assemblies

Connection fittings type VF20S

Sleeve for extraction, exhaust and conveying hoses type FA, FG, FS, SD

Design

Sleeve with L-slot, cylindrical

Mounting technique

Sealed and riveted, brazed and clamped

Materials

Stainless steel (1.4301)

Operating temperature

600 °C

Order text

Connection fitting type VF20S

DN	d ₂ mm	f mm	t mm	w mm	a mm	l mm	Weight approx. kg
50	53	9	20	15	50	80	0.10
60	63	9	20	15	50	90	0.15
70	73	9	20	15	50	90	0.17
80	83	9	20	15	50	90	0.19
100	103	9	25	25	60	110	0.29
120	123	9	25	25	60	110	0.34
125	128	9	25	25	60	110	0.36
140	144	9	30	25	70	130	0.71
150	154	9	30	25	70	130	0.75
180	184	9	30	25	70	130	0.89
200	204	11	40	30	90	160	1.29
250	255	11	40	30	90	160	2.11
300	305	11	40	30	100	180	2.81
315	320	11	40	30	100	180	2.94
350	355	11	45	30	110	200	3.64

When ordering, please specify: connection fitting type, nominal diameter (DN), mounting technique. Other dimensions upon request.

6.6 HYDRA® Stripwound hoses - fittings, hose assemblies

Connection fittings type VE20S

Sleeve for extraction, exhaust and conveying hoses type FA, FG, FS, SD

Design

Sleeve with pin, cylindrical

Mounting technique

Sealed and riveted, brazed and clamped

Materials

Stainless steel (1.4301)

Operating temperature

600 °C

Order text

Connection fitting type VE20S

DN	d ₁ mm	d ₃ mm	t mm	a mm	l mm	Weight approx. kg
50	52	8	20	50	80	0.11
60	62	8	20	50	90	0.16
70	72	8	20	50	90	0.18
80	82	8	20	50	90	0.20
100	102	8	25	60	110	0.30
120	122	8	25	60	110	0.35
125	127	8	25	60	110	0.37
140	142	8	30	70	130	0.73
150	152	8	30	70	130	0.77
180	182	8	30	70	130	0.91
200	202	10	40	90	160	1.33
250	252	10	40	90	160	2.16
300	302	10	40	100	180	2.87
315	317	10	40	100	180	3.00
350	352	10	45	110	200	3.71

When ordering, please specify: connection fitting type, nominal diameter (DN), mounting technique. Other dimensions upon request.

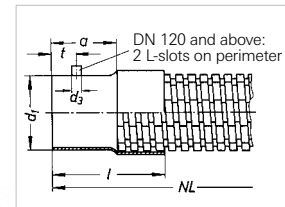
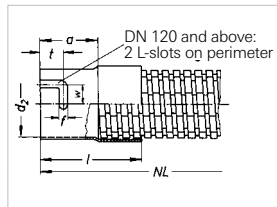

6.6 HYDRA® Stripwound hoses - fittings, hose assemblies

Connection fittings type EA

Flanged joint, swivelling for extraction, exhaust and conveying hoses
type FA, FG, FS, SD

Design

Flanged joint, swivelling

Mounting technique

- Sealed and riveted,
- Brazed and clamped

Operating temperature

- EA20S: 600 °C
- EA80S: 480 °C

Materials

- EA20S: stainless steel sleeve, stainless steel flange (1.4301)
- EA80S: stainless steel sleeve (1.4301), zinc-plated steel flange

Order text

Connection fitting type
EA20S or EA80S

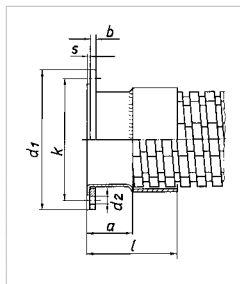

DN	Outside diameter d1	b	k	Number of holes	d2	s	a	l	Weight approx.
	mm	mm	mm	-	mm	mm	mm	mm	kg
50	115	6	89	4	9.5	1	40	70	0.11
60	125	6	99	4	9.5	1	40	80	0.16
70*	13	6	110	4	9.5	1	40	80	0.18
80*	142	6	118	4	9.5	1	40	80	0.20
100*	162	6	139	4	9.5	1	50	100	0.30
120*	187	6	165	4	9.5	1	50	100	0.35
125*	187	6	165	4	9.5	1	50	100	0.37
140*	212	6	182	8	11.5	1	60	120	0.73
180*	252	6	219	8	11.5	1	60	120	0.91
200*	273	6	241	8	11.5	1	60	130	1.33
250*	323	6	292	8	11.5	1	60	130	2.16
300*	383	8	349	8	11.5	1	60	140	2.87
315*	398.0	8	366	8	11.5	1	60	140	3.00
350*	438.0	8	405	8	11.5	1	60	150	3.71
400*	484.0	8	448	12	11.5	1	70	170	6.28
500*	584.0	8	551	12	11.5	1	70	170	8.86

* Dimensions acc. to DIN 24154/07/90. When ordering, please specify: connection fitting type, nominal diameter (DN), mounting technique. Other dimensions upon request.

6.6 HYDRA® Stripwound hoses - fittings, hose assemblies

Connection fittings type WE, WK

Quick release coupling for extraction, exhaust and conveying hoses
type FA, FG, FS, SD

Design

Type WE80S

- Coupling element with guide and clamp
- From DN 200: with 2 wooden handles

Type WK20S

- Flanged element with guide,
- Suitable for coupling element

Materials

Stainless steel

Operating temperature

600 °C

Available accessories

- Screen, zinc-plated steel
- Cover with chain, zinc-plated steel
- Handles, 1 pair, wood

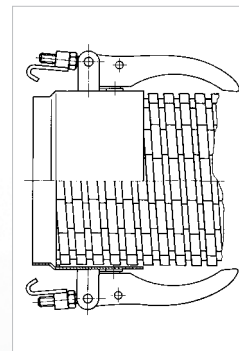

Mounting technique

Sealed and riveted,
Braze or clamped

DN	Clamp	Wooden handles
100	2 units	-
125	2 units	-
150	2 units	-
200	3 units	2 units
250	3 units	2 units
300	3 units	2 units
315	3 units	2 units

When ordering, please specify: connection fitting type, nominal diameter (DN), mounting technique.
Other dimensions on request.

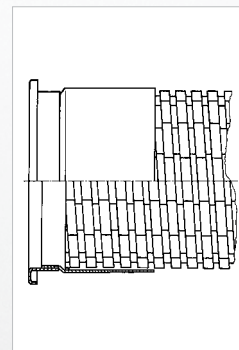

Flexible arms

Swan necks

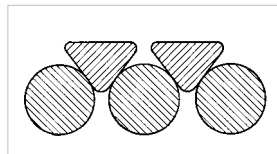

Applications

Flexible arm, popularly known as a "swan neck", used, amongst other things, as a lamp bracket hose or microphone arm. Applications are also common in the fibre optic field (such as cold light sources and measuring equipment), for welding shields, traffic-control systems, car phones, medical technology, etc.

Design

- Flexible and flexural stiffness at the same time
- Combination of interior round wire with a triangular wire spiral inserted from outside

Versions

Customised designs are common in many cases, however, we are only able to list the standard series here. If the standard series does not meet your demands and you have application-specific requirements, please let us know. Take advantage of our long-standing experience and expert advice.

Load capacity

The load capacity of the flexible arms depends on their nominal size (NS) and the length of the support coil. The term 'carrying length' (l) describes the length at which a vibration-free support coil, horizontally clamped on one side, is permitted to sink under its own weight by a distance not exceeding its own outside diameter. The diagram on the next page shows the relationship between nominal size (NS) and maximum load (p).

Installation note

Flexible arms are to be bent uniformly, the minimum bending radius must not be exceeded.

Delivery

At short notice

Order text

- Flexible arm, bright surface, NL 90 to 4000 mm, type BA 151L11
- Flexible arm, high-gloss nickel-plated, NL 90 to 760 mm, type BA 152L11
- Flexible arm, high-gloss chromium-plated, NL 90 to 760 mm, type BA 153L11
- Flexible arm, matt chromium-plated, NL 90 to 760 mm, type BA 154L11
- Flexible arm, matt black finish, NL 90 to 800 mm, type BA 156L11

Flexible arms type BA

Swan necks

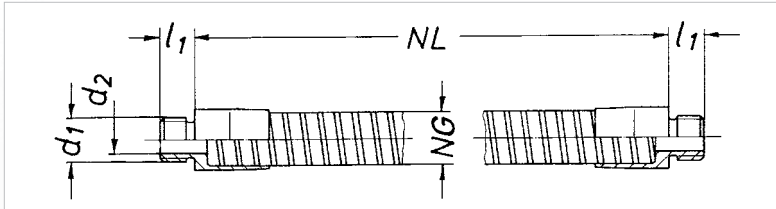

NS	Support coil		Connecting dimension			Minimum bending radius	Weight approx.
	Inner Ø	Tolerance	d ₁	d ₂	l ₁		
-	mm	mm	mm	mm	mm	mm	kg/ m
6	2.6	+ 0.2/ -0.1	M8 x 1	3.0	8	35	0.15
8	3.9	+ 0.1/ -0.2	M10 x 1	6.5	8	45	0.25
10	5.3	+ 0.1/ -0.2	M10 x 1	6.5	8	55	0.35
11	5.3	+ 0.1/ -0.2	M10 x 1	6.5	8	50	0.465
12	6.7	+ 0.1/ -0.2	M10 x 1	6.5	8	60	0.47
13	7.1	+ 0.1/ -0.2	M10 x 1	6.5	8	60	0.59
15	7.3	+ 0.1/ -0.2	M10 x 1	6.5	8	65	0.85
18	7.7	+ 0.1/ -0.3	M10 x 1	5.0	8	120	1.30

Flexible arms type BA

Swan necks, load diagram

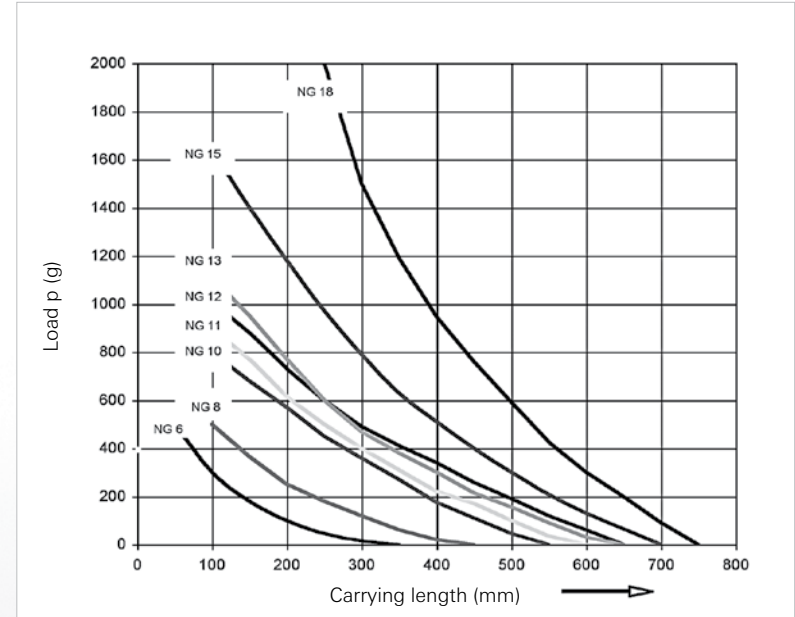

Flexible arms type FR

Coolant hoses

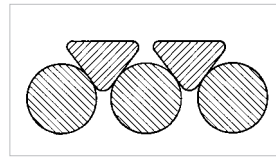
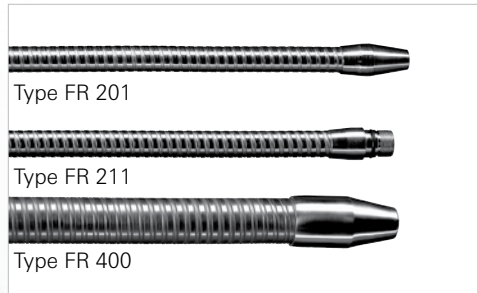

Applications

Coolant hoses feed liquid and gaseous coolants or lubricants for metal cutting. It is also possible to blow away shavings and metal residue in moulds, workpieces and punched parts.

Characteristics

- Small bending radius, therefore can be adjusted to any direction as required.
- Maintain alignment reliably even with heavy pressure without fatigue or vibration.
- Sturdy and wear-resistant
- Resistant to hot shavings, oils and fats

Design

- Support coil consists of two profile wires wound round each other
- A PVC hose is inserted in the middle

Types

A range of versions are available for different requirements:

- Type FR 201: standard versions with fixed screwed plug and outlet nozzle
- Type FR 211: refrigerant hose with connection for exchangeable nozzles
- Type FR 400: high-pressure hose assembly for heavy mechanical loads e.g. in foundries, in mechanical engineering and toolmaking, with plastic injection machines, on rollers as a separating spray pipe for cutting aids.

Flexible arms type FR

Coolant hoses

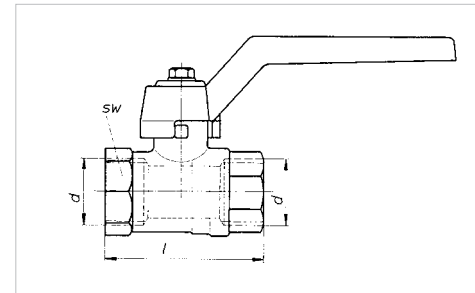

Accessories

- Stopcock ASP 321
- For Hydrafix refrigerant hoses
- Nickel-plated brass

DN	d Whitworth pipe thread 228/1	l mm	SW mm
6	G 1/4	45	22
8	G 3/8	45	22
10	G 1/2	55	27
16	G 3/4	65	32

6.6 HYDRA® Stripwound hoses - fittings, hose assemblies

Flexible arms type FR 201

Refrigerant hoses

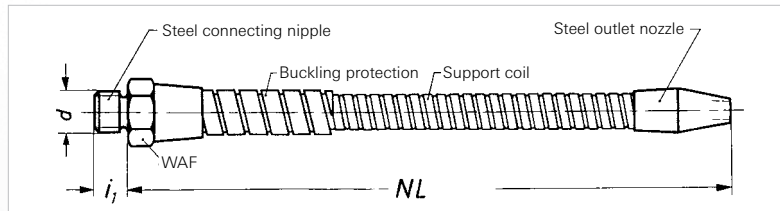

Steel supporting coil with PVC inner hose, screwed plug and outlet nozzle made of steel, nickel-plated hose surface with additional buckling protection up to and including DN 10.

DN	Screwed plug DIN 3852-A part 2		WAF	Minimum bending radius	Nominal length approx. NL						
	d	i ₁			± 5						
-	Inch	mm	mm	mm	mm						
4	G 1/8	8	15	64	200	250	320	400			
6	G 1/4	10	19	72	200	250	320	400	500	630	
8	G 3/8	10	24	88		250	320	400	500	630	
10	G 1/2	12	27	110			320	400	500	630	800
16	G 3/4	12	36	110					500	630	

Warehouse goods – available immediately, prior sale reserved

When ordering, please specify: type of hose, nominal diameter (DN) and nominal length (NL)

6.6 HYDRA® Stripwound hoses - fittings, hose assemblies

Flexible arms type FR 211

Refrigerant hoses

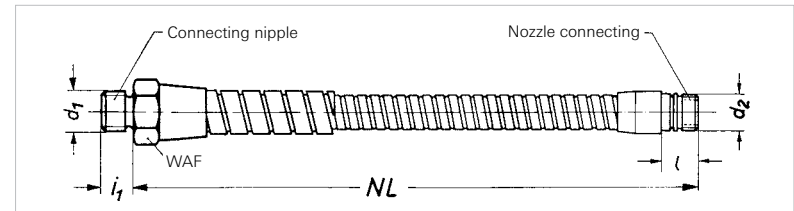

Steel supporting coil with PVC inner hose, screwed plug made of steel, connection with O-ring for exchangeable nozzles made of brass or aluminium, nickel-plated hose surface, with additional buckling protection up to and including DN 10.

DN	Screwed plug DIN 3852-A part 2		WAF	Nozzle connec- tion		Minimum bending radius	Nominal length approx. NL					
	d	i ₁		i			± 5					
-	Inch	mm	mm	mm	mm	mm	mm					
4	G 1/8	8	15	M10x1	12.0	64	220	250	320	400		
6	G 1/4	10	19	M12x1	15.5	72	200	250	320	400	500	
8	G 3/8	10	24	M16x1	17.5	88		250	320	400	500	630
10	G 1/2	12	27	M18x1	19.0	110			320	400	500	630
16	G 3/4	12	36	M26x1.5	27.0	110					500	630

Warehouse goods – available immediately, prior sale reserved

When ordering, please specify: type of hose, nominal diameter (DN) and nominal length (NL)

6.6 HYDRA® Stripwound hoses - fittings, hose assemblies

Flexible arms type DUE 110, DUE 411, DUE 510

Refrigerant hoses FR 211 accessories: exchangeable nozzles

Flat nozzle type DUE 110

- Aluminium, shiny

DN	d mm	l mm	Run-out b x e mm
4	M10 x 1	34	16 x 0.8
6	M12 x 1	40	21 x 1.4
8	M16 x 1	50	26 x 2.0
10	M18 x 1	60	32 x 2.5
16	M26 x 1.5	70	44 x 3.0

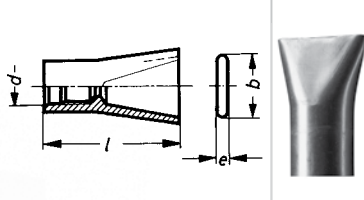

Adjusting nozzle type DUE 411

- Removable nozzle
- Nickel-plated brass

DN	d mm	l mm
4	M10 x 1	28
6	M12 x 1	36
8	M16 x 1	44
10	M18 x 1	52
16	M26 x 1.5	55

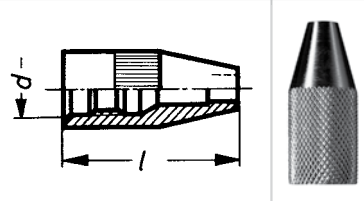

Special nozzle type DUE 510

- Undrilled nozzle, pre-turned
- For special self-made nozzle outlets
- Uncoated brass

DN	d ₁ mm	l mm	d ₂ mm
4	M10 x 1	28	12
6	M12 x 1	36	15
8	M16 x 1	44	19
10	M18 x 1	52	23
16	M26 x 1.5	55	31.5

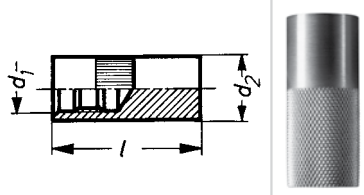

Warehouse goods – immediately available, prior sale reserved.

When ordering, please specify: type, nominal diameter (DN)

6.6 HYDRA® Stripwound hoses - fittings, hose assemblies

Flexible arms type FR 400

Refrigerant hoses

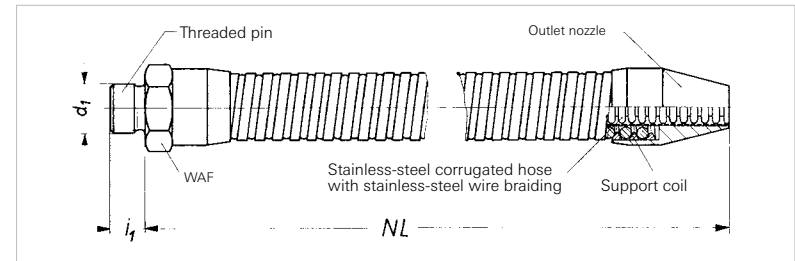

- Self-supporting high-pressure hose connection up to 250 °C
- Inner annularly corrugated hose with braid, made completely out of stainless steel
- Outer steel support coils, outlet nozzle and threaded brass pins

DN	Screwed plug DIN 3852-A part 2		WAF	Minimum bending radius	Nominal pressure PN	Nominal length approx. NL			
	d ₁	i ₁				± 5			
-	Inch	mm	mm	mm	bar	mm			
6	G 1/4	12	24	110	160	320	400	500	630
10	G 3/8	12	30	110	100	320	400	500	630

Available at short notice. When ordering, please specify:
type of hose, nominal diameter (DN)

DATA SHEETS

6.3 HYDRA annularly corrugated hoses - goods sold by the metre

RS 351 - Semi-flexible annularly corrugated hoses



- Semi-flexible annularly corrugated hose, mechanically corrugated
- Wall thickness: standard
- Versions:
 - IX 331 500 without braid
- Maximum production length: DN 12 - 25: 100 m
- Standard material: 1.4404
- Corrugation: flat

DN	Type	Inside diameter	Outside diameter	Permissible deviation	Minimum bending radius Single bend	Permissible operating pressure at 20 °C	Weight approx.
-	-	d	D	ΔD	r _{min}	P _{max}	-
-	-	mm	mm	mm	mm	bar	kg/m
12	IX311500	12.5	16.6	±0.3	20	10	0.265
16	IX311500	16.5	21.3	±0.3	16	17	0.125
20	IX311500	20.5	26.4	±0.4	20	9	0.165
25	IX311500	25.8	31.7	±0.4	25	10	0.36

The RS 351 is a semi-flexible hose and is primarily designed for static applications. This type of hose is not to be used for the absorption of repeated movements and vibrations. The RS 351 is optimised for self-assembly fittings.

136 WITZENMANN 1361uA/703/1610



1361uA/703/1610

WITZENMANN 137

7. Data sheets

7.1	Pipes, flanges, pipe bends, threads	262
7.2	Material data sheets	288
7.3	Nominal pressure levels for malleable iron	312
7.4	Corrosion resistance	313
7.5	Conversion tables, formula symbols, water steam table	352
7.6	Glossary	362
7.7	Inquiry specification	370



7.1 Pipes, flanges, pipe bends, threads

Seamless and welded steel pipes

DIN EN 10220, version 03.2003 (extract), dimensions and weights

Nominal diameter	Outside diameter	Standard wall thickness	Length-related dimensions (weights) in kg/m												
			Wall thickness in mm												
			1.6	1.8	2	2.3	2.6	2.9	3.2	3.6	4	4.5	5	5.6	
DN	mm	mm	1.6	1.8	2	2.3	2.6	2.9	3.2	3.6	4	4.5	5	5.6	
6	10.2	1.6	0.339	0.373	0.404	0.448	0.487								
8	13.5	1.8	0.47	0.519	0.567	0.635	0.699	0.758	0.813	0.879					
10	17.2	1.8	0.616	0.684	0.75	0.845	0.936	1.02	1.10	1.21	1.30	1.41			
15	21.3	2	0.777	0.866	0.952	1.08	1.20	1.32	1.43	1.57	1.71	1.86	2.01		
20	26.9	2	0.998	1.11	1.23	1.40	1.56	1.72	1.87	2.07	2.26	2.49	2.70	2.94	
25	33.7	2	1.27	1.42	1.56	1.78	1.99	2.20	2.41	2.67	2.93	3.24	3.54	3.88	
32	42.4	2.3	1.61	1.80	1.99	2.27	2.55	2.82	3.09	3.44	3.79	4.21	4.61	5.08	
40	48.3	2.3	1.84	2.06	2.28	2.61	2.93	3.25	3.56	3.97	4.37	4.86	5.34	5.90	
50	60.3	2.3	2.32	2.60	2.88	3.29	3.70	4.11	4.51	5.03	5.55	6.19	6.82	7.55	
65	76.1	2.6	2.94	3.30	3.65	4.19	4.71	5.24	5.75	6.44	7.11	7.95	8.77	9.74	
80	88.9	2.9	3.44	3.87	4.29	4.91	5.53	6.15	6.76	7.57	8.38	9.37	10.3	11.5	
100	114.3	3.2	4.45	4.99	5.54	6.35	7.16	7.97	8.77	9.83	10.9	12.2	13.5	15.0	
125	139.7	3.6	5.45	6.12	6.79	7.79	8.79	9.78	10.8	12.1	13.4	15.0	16.6	18.5	
150	168.3	4	6.58	7.39	8.20	9.42	10.6	11.8	13.0	14.6	16.2	18.2	20.1	22.5	
200	219.1	4.5		9.65	10.7	12.3	13.9	15.5	17.0	19.1	21.2	23.8	26.4	29.5	
250	273.0	5			13.4	15.4	17.3	19.3	21.3	23.9	26.5	29.8	33.0	36.9	
300	323.9	5.6					20.6	23.0	25.3	28.4	31.6	35.4	39.3	44.0	

7.1 Pipes, flanges, pipe bends, threads

Seamless and welded steel pipes

DIN EN 10220, version 03.2003 (extract), dimensions and weights

Nominal diameter	Outside diameter	Standard wall thickness	Length-related dimensions (weights) in kg/m																
			Wall thickness in mm																
			6.3	7.1	8	8.8	10	11	12.5	14.2	16	17.5	20	22.2					
DN	mm	mm	6.3	7.1	8	8.8	10	11	12.5	14.2	16	17.5	20	22.2					
6	10.2	1.6																	
8	13.5	1.8																	
10	17.2	1.8																	
15	21.3	2																	
20	26.9	2	3.20	3.47	3.73														
25	33.7	2	4.26	4.66	5.07	5.40													
32	42.4	2.3	5.61	6.18	6.79	7.29	7.99												
40	48.3	2.3	6.53	7.21	7.95	8.57	9.45	10.1	11.0										
50	60.3	2.3	8.39	9.32	10.3	11.2	12.4	13.4	14.7	16.1	17.5								
65	76.1	2.6	10.8	12.1	13.4	14.6	16.3	17.7	19.6	21.7	23.7	25.3	27.7						
80	88.9	2.9	12.8	14.3	16.0	17.4	19.5	21.1	23.6	26.2	28.8	30.8	34.0	36.5					
100	114.3	3.2	16.8	18.8	21.0	22.9	25.7	28.0	31.4	35.1	38.8	41.8	46.5	50.4					
125	139.7	3.6	20.7	23.2	26.0	28.4	32.0	34.9	39.2	43.9	48.8	52.7	59.0	64.3					
150	168.3	4	25.2	28.2	31.6	34.6	39.0	42.7	48.0	54.0	60.1	65.1	73.1	80.0					
200	219.1	4.5	33.1	37.1	41.6	45.6	51.6	56.5	63.7	71.8	80.1	87.0	98.2	108					
250	273.0	5	41.4	46.6	52.3	57.3	64.9	71.1	80.3	90.6	101	110	125	137					
300	323.9	5.6	49.3	55.5	62.3	68.4	77.4	84.9	96.0	108	121	132	150	165					

7.1 Pipes, flanges, pipe bends, threads

Austenitic, stainless steel pipes
DIN EN ISO 1127, version 03.1997 (extract), dimensions and weights

Nominal diameter	Outside diameter	Length-related dimensions (weights) in kg/m										
		Wall thickness in mm										
DN	mm	1.0	1.2	1.6	2.0	2.3	2.6	2.9	3.2	3.6	4.0	4.5
6	10.2	0.23	0.27	0.344	0.41							
8	13.5	0.313	0.369	0.477	0.575	0.645		0.789				
10	17.2	0.406		0.625	0.761	0.858			1.12			
15	21.3	0.509		0.789	0.966		1.22		1.45		1.74	
20	26.9	0.649		1.01	1.25		1.58	1.75	1.9		2.29	
25	33.7	0.818	0.976	1.29	1.58	1.81	2.02		2.45			3.29
32	42.4			1.63	2.02		2.59		3.14	3.49		
40	48.3			1.87	2.31		2.97		3.61	4.03		
50	60.3			2.35	2.92	3.34	3.76	4.17	4.58	5.11	5.83	
65	76.1			2.98	3.7	4.25	4.78	5.32		6.54	7.22	
80	88.9			3.49	4.35	4.98	5.61	6.24	6.86	7.68	8.51	
100	114.3			4.52	5.62		7.27	8.09		9.98		12.4
125	139.7			5.53	6.89		8.92		11		13.6	
150	168.3			6.68	8.32		10.8		13.2		16.4	18.5
200	219.1				10.9		14.1		17.3	19.4	21.5	
250	273.0				13.6		17.6		21.6	24.3	26.9	
300	323.9						20.9		25.7		32.1	35.9

7.1 Pipes, flanges, pipe bends, threads

Austenitic, stainless steel pipes
DIN EN ISO 1127, version 03.1997 (extract), dimensions and weights

Nominal diameter	Outside diameter	Length-related dimensions (weights) in kg/m										
		Wall thickness in mm										
DN	mm	5.0	5.6	6.3	7.1	8.0	8.8	10.0	11.0	12.5	14.2	
6	10.2											
8	13.5											
10	17.2											
15	21.3											
20	26.9											
25	33.7											
32	42.4	4.68										
40	48.3	5.42										
50	60.3		7.66									
65	76.1	8.9			12.3							
80	88.9		11.7			16.2						
100	114.3			17.1			23.2					
125	139.7	16.8		21	23.5			32.5				
150	168.3	20.4			28.6				43.3			
200	219.1			33.6		42.2					64.7	
250	273.0			42				65.9			81.5	92
300	323.9	39.9			56.3				78.6			97.4

Tolerance class	Tolerance limits for outside diameter	
D ₁	± 1.5 %	with min. ± 0.75 mm
D ₂	± 1 %	with min. ± 0.50 mm
D ₃	± 0.75 %	with min. ± 0.30 mm
D ₄	± 0.5 %	with min. ± 0.10 mm

Tolerance class	Dimension tolerances for wall thickness	
T ₁	± 15 %	with min. ± 0.60 mm
T ₂	± 12.5 %	with min. ± 0.40 mm
T ₃	± 10 %	with min. ± 0.20 mm
T ₄	± 7.5 %	with min. ± 0.15 mm
T ₅	± 5 %	with min. ± 0.10 mm

7.1 Pipes, flanges, pipe bends, threads

Types of joint for steel pipes, guidelines for fusion welding of butt joints, weld edge preparation according to DIN EN ISO 9692-1, version 05.2004

Code number	Wall thickness	Name	Symbol ¹⁾	Joint types (cross section)	Dimensions				
					Bevel angle approx.		Root spacing ²⁾	Thickness of root face	Root depth
-	s	-	-	-	α	β	b	c	h
-	mm	-	-	-	grd	grd	mm	mm	mm
1	Up to 3	square butt			-	-	0 to 3	-	-
2	Up to 16	single V			40 to 60 for SG 60 for E and G	-	0 to 4	Up to 2	-
3	over 12	single U			60	8	0 to 3	Up to 2	-
4	over 12	single U on V-root			-	8	0 to 3	-	~ 4

1) For additional signs, see DIN 1912.

2) The indicated dimensions apply to tacked condition.

7.1 Pipes, flanges, pipe bends, threads

Standard flanges

DIN EN 1092: version 04.2013 (extract)

Connection dimensions PN 2.5 / PN 6

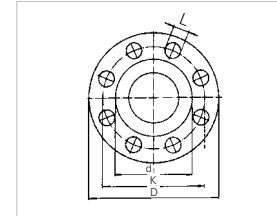

	DIN EN 1092
Outside diameter	D
Sealing ring diameter	d ₁
Hole circle diameter	K
Bolt hole diameter	L

Nominal diameter	Nominal pressure 2.5						Nominal pressure 6					
	Bolts			Bolts			Bolts			Bolts		
DN	D	d ₁	K	Quantity	Thread	L	D	d ₁	K	Quantity	Thread	L
10							75	35	50	4	M 10	11
15							80	40	55	4	M 10	11
20							90	50	65	4	M 10	11
25							100	60	75	4	M 10	11
32							120	70	90	4	M 12	14
40							130	80	100	4	M 12	14
50	Connection dimensions, see nominal pressure 6						140	90	110	4	M 12	14
65							160	110	130	4	M 12	14
80							190	128	150	4	M 16	18
100							210	148	170	4	M 16	18
125							240	178	200	8	M 16	18
150							265	202	225	8	M 16	18
200							320	258	280	8	M 16	18
250							375	312	335	12	M 16	18
300							440	365	395	12	M 20	22

7.1 Pipes, flanges, pipe bends, threads

Standard flanges

DIN EN 1092: version 04.2013 (extract)

Connection dimensions PN 10 / PN 16

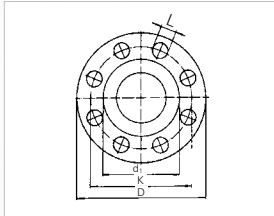

	DIN EN 1092
Outside diameter	D
Sealing ring diameter	d ₁
Hole circle diameter	K
Bolt hole diameter	L

Nominal diameter	Nominal pressure 10						Nominal pressure 16					
	D	d ₁	K	Bolts		L	D	d ₁	K	Bolts		L
DN				Quantity	Thread					Quantity	Thread	
10	Connection dimensions, see nominal pressure 40						Connection dimensions, see nominal pressure 40					
15												
20												
25												
32												
40	Connection dimensions, see nominal pressure 16						165	102	125	4	M16	18
50							185	122	145	8	M16	18
65							200	138	160	8*	M16	18
80							220	158	180	8	M 16	18
100							250	188	210	8	M 16	18
125							285	212	240	8	M 20	22
150												
200	340	268	295	8	M 20	22	340	268	295	12	M 20	22
250	395	320	350	12	M 20	22	405	320	355	12	M 24	26
300	445	370	400	12	M 20	22	460	378	410	12	M 24	26

* DIN EN 1092: 8 screws, 4 screws permissible for steel flanges by agreement

7.1 Pipes, flanges, pipe bends, threads

Standard flanges

DIN EN 1092: version 04.2013 (extract)

Connection dimensions PN 25 / PN 40

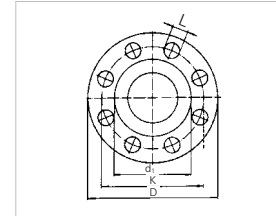

	DIN EN 1092
Outside diameter	D
Sealing ring diameter	d ₁
Hole circle diameter	K
Bolt hole diameter	L

Nominal diameter	Nominal pressure 25						Nominal pressure 40											
	D	d ₁	K	Bolts		L	D	d ₁	K	Bolts		L						
DN				Quantity	Thread				Quantity	Thread								
10	Connection dimensions, see nominal pressure 40						90	40	60	4	M 12	14						
15							95	45	65	4	M 12	14						
20							105	58	75	4	M 12	14						
25							115	68	85	4	M 12	14						
32							140	78	100	4	M 16	18						
40							150	88	110	4	M 16	18						
50							165	102	125	4	M 16	18						
65							185	122	145	8	M 16	18						
80							200	138	160	8	M 16	18						
100							235	162	190	8	M 20	22						
125							270	188	220	8	M 24	26						
150							300	218	250	8	M 24	26						
200							360	278	310	12	M 24	26	375	285	320	12	M 27	30
250							425	335	370	12	M 27	30	450	345	385	12	M 30	33
300							485	395	430	16	M 27	30	515	410	450	16	M 30	33

7.1 Pipes, flanges, pipe bends, threads

Standard flanges

DIN EN 1092: version 04.2013 (extract)

Connection dimensions PN 63 / PN 100

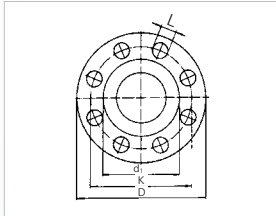

	DIN EN 1092
Outside diameter	D
Sealing ritch diameter	d_1
Hole circle diameter	K
Bolt hole diameter	L

No- minal dia- meter	Nominal pressure 63						Nominal pressure 100					
	Bolts			Bolts			Bolts			Bolts		
DN	D	d_1	K	Quantity	Thread	L	D	d_1	K	Quantity	Thread	L
10	Connection dimensions, see nominal pressure 100						100	40	70	4	M 12	14
15							105	45	75	4	M 12	14
20							130	58	90	4	M 16	18
25							140	68	100	4	M 16	18
32							155	78	110	4	M 20	22
40							170	88	125	4	M 20	22
50							180	102	135	4	M 20	22
65	205	122	160	8	M 20	22	220	122	170	8	M 24	26
80	215	138	170	8	M 20	22	230	138	180	8	M 24	26
100	250	162	200	8	M 24	26	265	162	210	8	M 27	30
125	295	188	240	8	M 27	30	315	188	250	8	M 30	33
150	345	218	280	8	M 30	33	355	218	290	12	M 30	33
200	415	285	345	12	M 33	36	430	285	360	12	M 33	36
250	470	345	400	12	M 33	36	505	345	430	12	M 36	39
300	530	410	460	16	M 33	36	585	410	500	16	M 39	42

7.1 Pipes, flanges, pipe bends, threads

Plain flanges

DIN 24154 part 2: version 07.1990 (extract)

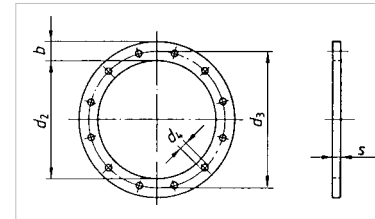

No- minal dia- meter	Inside diameter		Width x thickness	Hole circle diameter ± 0.5	Bolt hole diameter ± 0.5	Number of holes	Bolts	Weight approx.
	d_2	Tolerance						
DN	d_2	-	$b \times s^1$	d_3	d_4	-	-	-
-	mm	-	mm	mm	mm	-	-	kg
71	73	+ 1 0	30 x 6	110	9.5	4	M 8	0.44
80	82			118				0.48
90	92			128				0.53
100	102			139				0.55
112	114			151				0.63
125	127	165	0.68					
140	142	182	35 x 6	11.5	8	M 10	0.87	
160	162	200					0.98	
180	182	219					1.08	
200	203	241					1.19	
224	227	265					1.32	
250	253	292	1.45					
280	283	332	40 x 8	11.5	8	M10	2.51	
315	318	366					2.98	
355	358	405					3.10	
400	404	448					3.44	
450	454	497			12	3.84		
500	504	551	4.13					

¹⁾ Tolerance limits for width b and thickness s according to DIN 1016, **bold-printed** nominal distances are preferable

7.1 Pipes, flanges, pipe bends, threads

Comparison of sealing surfaces according to the previous DIN standards and DIN EN 1092-1

Old descriptions according to DIN	New descriptions according to DIN EN 1092-1
Form A	Form A
Form B	
Form C	Form B 1
Form D	
Form E	Form B 2
Form F	Form C
Form N	Form D
Form V 13	Form E
Form R 13	Form F
Form R 14	Form G
Form V 14	Form H

Flange with tongue or groove
DIN EN 1092: version 06.2002 (extract)

Dimensions (tongue, groove), PN 10 to PN 160 / 100

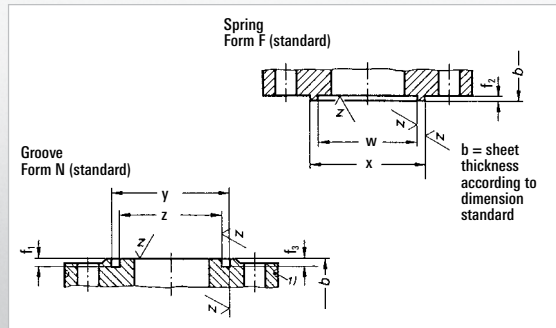

DIN EN 1092
w
x
z
y
f ₁
f ₂
f ₃
Sealing face twisted: $\sqrt{r} = \sqrt{R.3.2-12,5}$

7.1 Pipes, flanges, pipe bends, threads

Nominal diameter	Tongue			Groove		
	w	x	f ₂	z	y	f ₃
DN	+0.5 0	0 -0.5	+0.5 0	0 -0.5	+0.5 0	+0.5 0
10	24	34	4.5	23	35	4.0
15	29	39		28	40	
20	36	50		35	51	
25	43	57		42	58	
32	51	65		50	66	
40	61	75		60	76	
50	73	87	72	88		
65	95	109	94	110		
80	106	120	105	121		
100	129	149	5.0	128	150	4.5
125	155	175		154	176	
150	183	203		182	204	
200	239	259		238	260	
250	292	312		291	313	
300	343	363		342	364	

7.1 Pipes, flanges, pipe bends, threads

Flange as per USA standard
ANSI B 16.5

Connection dimensions Class 150

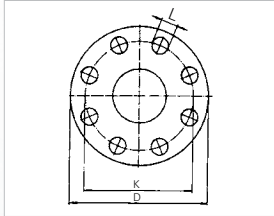

D Outside diameter
K Hole circle diameter
L Bolt hole diameter

Nominal diameter		Flange				Bolts				
		Outside diameter		Hole circle diameter		Quantity	Hole diameter		Thread	
DN		D		K			-	L		-
-	Inch	mm	Inch	mm	Inch	-	mm	Inch	mm	Inch
15	½	88.9	3 ½	60.3	2 ¾	4	15.9	¾	12.7	½
20	¾	98.4	3 ¾	69.8	2 ¾	4	15.9	¾	12.7	½
25	1	107.9	4 ¼	79.4	3 ¾	4	15.9	¾	12.7	½
32	1 ¼	117.5	4 ⅝	88.9	3 ½	4	15.9	¾	12.7	½
40	1 ½	127.0	5	98.4	3 ⅞	4	15.9	¾	12.7	½
50	2	152.4	6	120.6	4 ¾	4	19.0	¾	15.9	⅝
65	2 ½	177.8	7	139.7	5 ½	4	19.0	¾	15.9	⅝
80	3	190.5	7 ½	152.4	6	4	19.0	¾	15.9	⅝
100	4	228.6	9	190.5	7 ½	8	19.0	¾	15.9	⅝
125	5	254.0	10	215.9	8 ½	8	22.2	⅞	19.0	¾
150	6	279.4	11	241.3	9 ½	8	22.2	⅞	19.0	¾
200	8	342.9	13 ½	298.4	11 ¾	8	22.2	⅞	19.0	¾
250	10	406.4	16	361.9	14 ¼	12	25.4	1	22.2	⅞
300	12	482.6	19	431.8	17	12	25.4	1	22.2	⅞

7.1 Pipes, flanges, pipe bends, threads

Flange as per USA standard
ANSI B 16.5

Connection dimensions Class 300

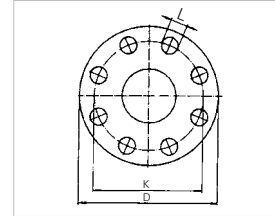

D Outside diameter
K Hole circle diameter
L Bolt hole diameter

Nominal diameter		Flange				Bolts				
		Outside diameter		Hole circle diameter		Quantity	Hole diameter		Thread	
DN		D		K			-	L		-
-	Inch	mm	Inch	mm	Inch	-	mm	Inch	mm	Inch
15	½	95.2	3 ½	66.7	2 ¾	4	15.9	¾	12.7	½
20	¾	117.5	3 ¾	82.5	3 ¼	4	19.0	¾	15.9	⅝
25	1	123.8	4 ¼	88.9	3 ½	4	19.0	¾	15.9	⅝
32	1 ¼	133.3	4 ⅝	98.4	3 ⅞	4	19.0	¾	15.9	⅝
40	1 ½	155.6	5	114.3	4 ½	4	22.2	⅞	19.0	¾
50	2	165.1	6	127.0	5	8	19.0	¾	15.9	⅝
65	2 ½	190.5	7	149.2	5 ⅞	8	22.2	⅞	19.0	¾
80	3	209.5	7 ½	168.3	6 ⅝	8	22.2	⅞	19.0	¾
100	4	254.0	9	200.0	7 ⅞	8	22.2	⅞	19.0	¾
125	5	279.4	10	234.9	9 ¼	8	22.2	⅞	19.0	¾
150	6	317.5	11	269.9	10 ⅝	12	22.2	⅞	19.0	¾
200	8	381.0	13 ½	330.2	13	12	25.4	1	22.2	⅞
250	10	444.5	16	387.3	15 ¼	16	28.6	1 ⅛	25.4	1
300	12	520.7	19	450.8	17 ¾	16	31.7	1 ¼	28.6	1 ⅛

7.1 Pipes, flanges, pipe bends, threads

Flange as per USA standard
ANSI B 16.5

Connection dimensions Class 400

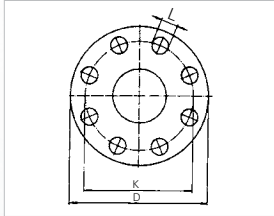

D Outside diameter
K Hole circle diameter
L Bolt hole diameter

Nominal diameter		Flange				Bolts				
		Outside diameter		Hole circle diameter		Quantity	Hole diameter		Thread	
DN		D		K			-	L		-
-	Inch	mm	Inch	mm	Inch	-	mm	Inch	mm	Inch
15	½	95.2	3 ¾	66.7	2 ⅝	4	15.9	⅝	12.7	½
20	¾	117.5	4 ⅝	82.5	3 ¼	4	19.0	¾	15.9	⅝
25	1	123.8	4 ⅞	88.9	3 ½	4	19.0	¾	15.9	⅝
32	1 ¼	133.3	5 ¼	98.4	3 ⅞	4	19.0	¾	15.9	⅝
40	1 ½	155.6	6 ⅞	114.3	4 ½	4	22.2	⅞	19.0	¾
50	2	165.1	6 ½	127.0	5	8	19.0	¾	15.9	⅝
65	2 ½	190.5	7 ½	149.2	5 ⅞	8	22.2	⅞	19.0	¾
80	3	209.5	8 ¼	168.3	6 ⅞	8	22.2	⅞	19.0	¾
100	4	254.0	10	200.0	7 ⅞	8	25.4	1	22.2	⅞
125	5	279.4	11	234.9	9 ¼	8	25.4	1	22.2	⅞
150	6	317.5	12 ½	269.9	10 ⅞	12	25.4	1	22.2	⅞
200	8	381.0	15	330.2	13	12	28.6	1 ⅝	25.4	1
250	10	444.5	17 ½	387.3	15 ¼	16	31.7	1 ¼	28.6	1 ⅝
300	12	520.7	20 ½	450.8	17 ¾	16	34.9	1 ⅝	31.7	1 ¼

7.1 Pipes, flanges, pipe bends, threads

Flange as per USA standard
ANSI B 16.5

Connecting dimensions class 600

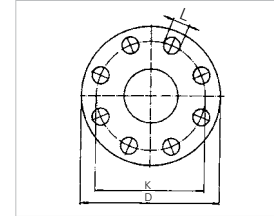

D Outside diameter
K Hole circle diameter
L Bolt hole diameter

Nominal diameter		Flange				Bolts				
		Outside diameter		Hole circle diameter		Quantity	Hole diameter		Thread	
DN		D		K			-	L		-
-	Inch	mm	Inch	mm	Inch	-	mm	Inch	mm	Inch
15	½	95.2	3 ¾	66.7	2 ⅝	4	15.9	⅝	12.7	½
20	¾	117.5	4 ⅝	82.5	3 ¼	4	19.0	¾	15.9	⅝
25	1	123.8	4 ⅞	88.9	3 ½	4	19.0	¾	15.9	⅝
32	1 ¼	133.3	5 ¼	98.4	3 ⅞	4	19.0	¾	15.9	⅝
40	1 ½	155.6	6 ⅞	114.3	4 ½	4	22.2	⅞	19.0	¾
50	2	165.1	6 ½	127.0	5	8	19.0	¾	15.9	⅝
65	2 ½	190.5	7 ½	149.2	5 ⅞	8	22.2	⅞	19.0	¾
80	3	209.5	8 ¼	168.3	6 ⅞	8	22.2	⅞	19.0	¾
100	4	273.0	10 ¾	215.9	8 ½	8	25.4	1	22.2	⅞
125	5	330.2	13	266.7	10 ½	8	28.6	1 ⅝	25.4	1
150	6	355.6	14	292.1	11 ½	12	28.6	1 ⅝	25.4	1
200	8	419.1	16 ½	349.2	13 ¾	12	31.7	1 ¼	28.6	1 ⅝
250	10	508.0	20	431.8	17	16	34.9	1 ⅝	31.7	1 ¼
300	12	558.8	22	488.9	19 ¼	20	34.9	1 ⅝	31.7	1 ¼

7.1 Pipes, flanges, pipe bends, threads

Pipe bend 90°

DIN 2605, part 1, version 1991-02 (extract)

Dimensions

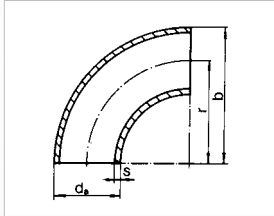

Nominal diameter	Outside diameter	Wall thickness	Type 2: $r \sim 1.0 \times d_a$		Type 3: $r \sim 1.5 \times d_a$	
			r	b	r	b
DN	d_a	s	r	b	r	b
-	mm	mm	mm	mm	mm	mm
15	21.3	2	17.5	28	28	38
20	26.9	2.3	25	39	29	43
25	33.7	2.6	25	42	38	56
32	42.4	2.6	32	53	48	69
40	48.3	2.6	38	62	57	82
50	60.3	2.9	51	81	76	106
65	76.1	2.9	63	102	95	133
80	88.9	3.2	76	121	114	159
100	114.3	3.6	102	159	152	210
125	139.7	4.0	127	197	190	260
150	168.3	4.5	152	237	229	313
200	219.1	6.3	203	313	305	414
250	273	6.3	254	391	381	518
300	323.9	7.1	305	467	457	619

The wall thickness s conforms with the nominal diameter DN 300 of the normal wall thickness (row 1) according to DIN EN 10220 or DIN EN ISO 1127

7.1 Pipes, flanges, pipe bends, threads

Pipe thread for joints not sealing in the thread

DIN EN ISO 228-1, version 2003-05 (extract)

Application

This international standard sets out the description, dimensions and tolerances of pipe threads for connections that do not fit flush in the thread.

Examples for the complete thread description for a thread of rated size 1 1/2

Inside thread	(only one tolerance class)	Pipe thread DIN EN ISO 228-G 1 1/2
External thread	Tolerance class A	Pipe thread DIN EN ISO 228-G 1 1/2 A
	Tolerance class B	Pipe thread DIN EN ISO 228/1-G 1 1/2 B

Thread profile and tolerance fields

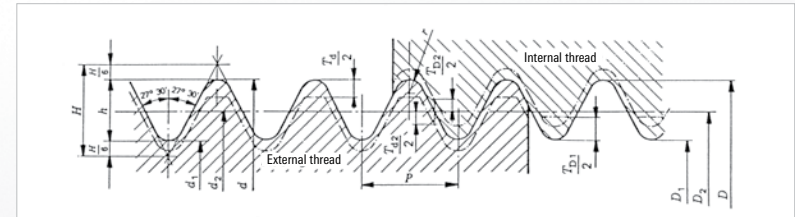

7.1 Pipes, flanges, pipe bends, threads

Pipe thread for joints not sealing in the thread
DIN EN ISO 228-1

Thread dimensions

Thread size	Threads per inch (25.4 mm)	Pitch	Depth of thread	Diameter		
				Outside diameter	Pitch diameter	Core diameter
-	-	P	h	d = D	d ₂ = D ₂	d ₁ = D ₁
-	mm	mm	mm	mm	mm	mm
1/16	28	0.907	0.581	7.723	7.142	6.561
1/8	28	0.907	0.581	9.728	9.147	8.566
1/4	19	1.337	0.856	13.157	12.301	11.445
3/8	19	1.337	0.856	16.662	15.806	14.95
1/2	14	1.814	1.162	20.955	19.793	18.631
5/8	14	1.814	1.162	22.911	21.749	20.587
3/4	14	1.814	1.162	26.441	25.279	24.117
7/8	14	1.814	1.162	30.201	29.039	27.877
1	11	2.309	1.479	33.249	31.77	30.291
	11	2.309	1.479	37.897	36.418	34.939
1 1/4	11	2.309	1.479	41.91	40.431	38.952
1 1/2	11	2.309	1.479	47.803	46.324	44.845
1 3/4	11	2.309	1.479	53.746	52.267	50.788
2	11	2.309	1.479	59.614	58.135	56.656
2 1/4	11	2.309	1.479	65.71	64.231	62.752
2 1/2	11	2.309	1.479	75.184	73.705	72.226
2 3/4	11	2.309	1.479	81.534	80.055	78.576
3	11	2.309	1.479	87.884	86.405	84.926
3 1/2	11	2.309	1.479	100.33	98.851	97.372
4	11	2.309	1.479	113.030	111.551	110.072
4 1/2	11	2.309	1.479	125.73	124.251	122.772
5	11	2.309	1.479	138.43	136.951	135.472
5 1/2	11	2.309	1.479	151.13	149.651	148.172
6	11	2.309	1.479	163.83	162.351	160.872

7.1 Pipes, flanges, pipe bends, threads

Pipe thread for joints not sealing in the thread
DIN EN ISO 228-1

Tolerances

Thread size	Tolerances for pitch diameter ¹⁾					Tolerances for core diameter		Tolerances for outside diameter	
	Inside thread T _{D2}		External thread T _{d2}			Inside thread T _{D1}		External thread T _{d1}	
	Lower tolerance limit	Upper tolerance limit	Lower limit of tolerance class A	Lower tolerance limit class B	Upper tolerance limit	Lower tolerance limit	Upper tolerance limit	Lower tolerance limit	Upper tolerance limit
-	mm	mm	mm	mm	mm	mm	mm	mm	mm
1/16	0	+ 0.107	- 0.107	- 0.214	0	0	+ 0.282	- 0.214	0
1/8	0	+ 0.107	- 0.107	- 0.214	0	0	+ 0.282	- 0.214	0
1/4	0	+ 0.125	- 0.125	- 0.25	0	0	+ 0.445	- 0.25	0
3/8	0	+ 0.125	- 0.125	- 0.25	0	0	+ 0.445	- 0.25	0
1/2	0	+ 0.142	- 0.142	- 0.284	0	0	+ 0.541	- 0.284	0
5/8	0	+ 0.142	- 0.142	- 0.284	0	0	+ 0.541	- 0.284	0
3/4	0	+ 0.142	- 0.142	- 0.284	0	0	+ 0.541	- 0.284	0
7/8	0	+ 0.142	- 0.142	- 0.284	0	0	+ 0.541	- 0.284	0
1	0	+ 0.18	- 0.18	- 0.36	0	0	+ 0.64	- 0.36	0
1 1/8	0	+ 0.18	- 0.18	- 0.36	0	0	+ 0.64	- 0.36	0
1 1/4	0	+ 0.18	- 0.18	- 0.36	0	0	+ 0.64	- 0.36	0
1 1/2	0	+ 0.18	- 0.18	- 0.36	0	0	+ 0.64	- 0.36	0
1 3/4	0	+ 0.18	- 0.18	- 0.36	0	0	+ 0.64	- 0.36	0
2	0	+ 0.18	- 0.18	- 0.36	0	0	+ 0.64	- 0.36	0
2 1/4	0	+ 0.217	- 0.217	- 0.434	0	0	+ 0.64	- 0.434	0
2 1/2	0	+ 0.217	- 0.217	- 0.434	0	0	+ 0.64	- 0.434	0
2 3/4	0	+ 0.217	- 0.217	- 0.434	0	0	+ 0.64	- 0.434	0
3	0	+ 0.217	- 0.217	- 0.434	0	0	+ 0.64	- 0.434	0
3 1/2	0	+ 0.217	- 0.217	- 0.434	0	0	+ 0.64	- 0.434	0
4	0	+ 0.217	- 0.217	- 0.434	0	0	+ 0.64	- 0.434	0
4 1/2	0	+ 0.217	- 0.217	- 0.434	0	0	+ 0.64	- 0.434	0
5	0	+ 0.217	- 0.217	- 0.434	0	0	+ 0.64	- 0.434	0
5 1/2	0	+ 0.217	- 0.217	- 0.434	0	0	+ 0.64	- 0.434	0
6	0	+ 0.217	- 0.217	- 0.434	0	0	+ 0.64	- 0.434	0

¹⁾ With thin-walled parts, to assess the dimensional stability, that thread diameter must be used as a base which results from the arithmetical average of two diameter measurements taken at 90° apart.

7.1 Pipes, flanges, pipe bends, threads

Pipe thread for joints sealing in the thread
DIN EN 10226-1, version 2004-10 (extract), ISO 7-1, version 1994 (extract)

Thread profile and tolerance fields

Application

This standard applies to connections for cylindrical female threads to fittings, threaded flanges etc. to tapered male threads.

If necessary, a suitable sealant may be used in the thread to ensure a tight connection.

Cylindrical female thread (Designation Rp)

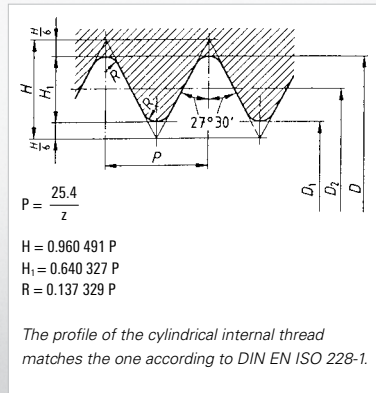

Description of a

- Conical right-hand thread with pipe male thread of rated size $1/2$ pipe thread DIN EN 10226 R $1/2$
- Cylindrical pipe female thread of rated size $1/2$ pipe thread DIN EN 10226 R $1/2$

Tapered male thread (Designation R)

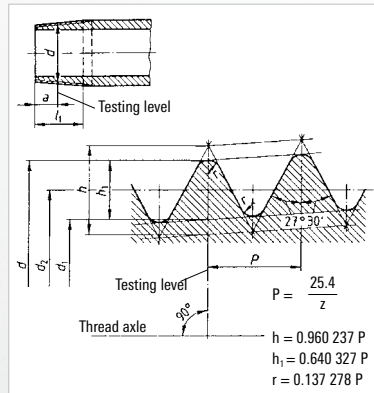

7.1 Pipes, flanges, pipe bends, threads

Pipe thread for joints sealing in the thread
DIN EN 10226-1

Rated dimension

Designation	No-nominal diameter of pipes	Position of reference plane	Outside diameter	Pitch diameter	Core diameter	Pitch	Threads per inch (25.4 mm)	Depth of threaded	Rounding approx.	Effective thread length	
External thread	Inside thread										
-	-	-	a	d = D	d ₂ = D ₂	d ₁ = D ₁	P	Z	h ₁ = H ₁	r = R	l ₁
-	-	mm	mm	mm	mm	mm	grd	-	-	-	mm
R 1/16	Rp 1/16	3	4.0	7.723	7.142	6.561	0.907	28	0.581	0.125	6.5
R 1/8	Rp 1/8	6	4.0	9.728	9.147	8.566	0.907	28	0.581	0.125	6.5
R 1/4	Rp 1/4	8	6.0	13.157	12.301	11.445	1.337	19	0.856	0.184	9.7
R 3/8	Rp 3/8	10	6.4	16.662	15.806	14.95	1.337	19	0.856	0.184	10.1
R 1/2	Rp 1/2	15	8.2	20.955	19.793	18.631	1.814	14	1.162	0.249	13.2
R 3/4	Rp 3/4	20	9.5	26.441	25.279	24.117	1.814	14	1.162	0.249	14.5
R 1	Rp 1	25	10.4	33.249	31.77	30.291	2.309	11	1.479	0.317	16.8
R 1 1/4	Rp 1 1/4	32	12.7	41.91	40.431	38.952	2.309	11	1.479	0.317	19.1
R 1 1/2	Rp 1 1/2	40	12.7	47.803	46.324	44.845	2.309	11	1.479	0.317	19.1
R 2	Rp 2	50	15.9	59.614	58.135	56.656	2.309	11	1.479	0.317	23.4
R 2 1/2	Rp 2 1/2	65	17.5	75.184	73.705	72.226	2.309	11	1.479	0.317	26.7
R 3	Rp 3	80	20.6	87.884	86.405	84.926	2.309	11	1.479	0.317	29.8
R 4	Rp 4	100	25.4	113.030	111.551	110.072	2.309	11	1.479	0.317	35.8
R 5	Rp 5	125	28.6	138.43	136.951	135.472	2.309	11	1.479	0.317	40.1
R 6	Rp 6	150	28.6	163.83	162.351	160.872	2.309	11	1.479	0.317	40.1

7.1 Pipes, flanges, pipe bends, threads

USA standard: tapered pipe thread NPT
ANSI B1.20.1, version 1983 (extract)

Sample designations

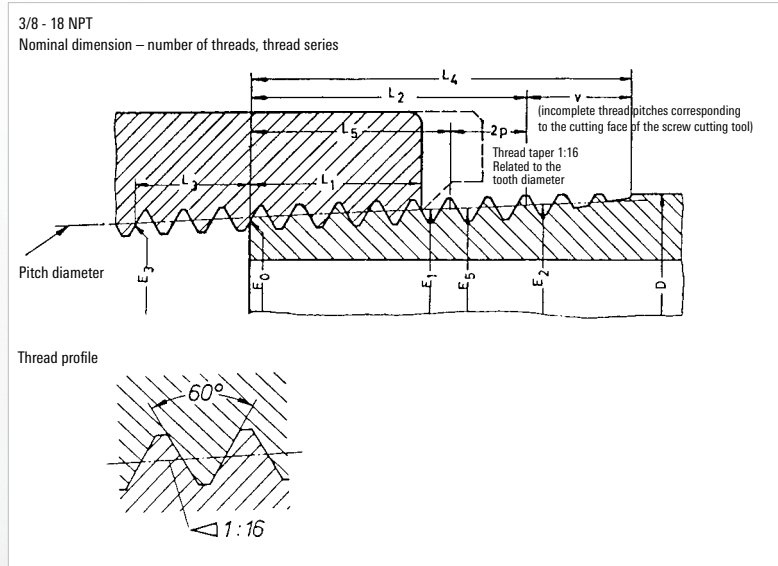

7.1 Pipes, flanges, pipe bends, threads

USA standard: tapered pipe thread NPT
ANSI B1.20.1

Rated dimension

Rated size of the pipe	Pipe outside diameter	Number of threads per 1 inch	Pitch	Thread diameter at start of male thread	Effective male thread		
					Length		Diameter
-	D	n	P	E ₀	L ₂	-	E ₂
Inch	mm	-	grd	mm	mm	-	mm
1/16	7.938	27	0.941	6.888	6.632	7.05	7.3025
1/8	10.287	27	0.941	9.2332	6.703	7.12	9.652
1/4	13.716	18	1.411	12.1257	10.206	7.23	12.7635
3/8	17.145	18	1.411	15.5451	10.358	7.34	16.1925
1/2	21.336	14	1.814	19.2641	13.556	7.47	20.1115
3/4	26.67	14	1.814	24.5791	13.861	7.64	25.4455
1	33.401	11 1/2	2.209	30.8262	17.343	7.85	31.91
1 1/4	42.164	11 1/2	2.209	39.5511	17.953	8.13	40.673
1 1/2	48.26	11 1/2	2.209	45.6207	18.377	8.32	46.769
2	60.325	11 1/2	2.209	57.6331	19.215	8.70	58.834
2 1/2	73.025	8	3.175	69.0761	28.892	9.10	70.8817
3	88.90	8	3.175	84.8517	30.48	9.60	86.7567
3 1/2	101.60	8	3.175	97.4725	31.75	10.00	99.4567
4	114.30	8	3.175	110.0933	33.020	10.40	112.1567
5	141.30	8	3.175	136.9245	35.72	11.25	139.1569
6	168.275	8	3.175	163.9245	38.418	12.10	166.1317
8	219.075	8	3.175	214.2132	43.498	13.70	216.9317
10	273.050	8	3.175	267.8509	48.895	15.40	270.9067
12	323.85	8	3.175	318.3334	53.975	17.00	321.7067

7.1 Pipes, flanges, pipe bends, threads

USA standard: tapered pipe thread NPT
ANSI B1.20.1

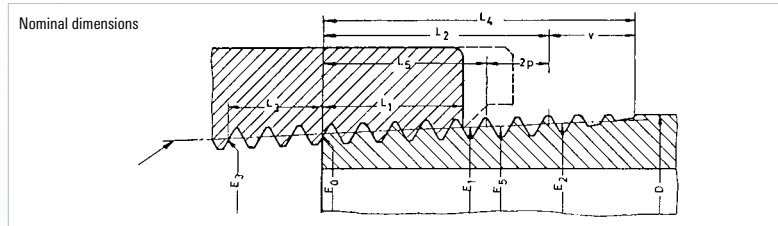

Rated size of the pipe	Length of engagement by hand		Length of engagement with mechanical bolting for female threads			Thread runout	
	Length	Diameter	Length	Threads	Diameter	v	Threads
	L ₁	E ₁	L ₃	-	E ₃	mm	-
-	mm	mm	mm	-	mm	mm	-
Inch	mm	mm	mm	-	mm	mm	-
1/16	4.064	7.142	2.822	3	6.7117	3.264	3.47
1/8	4.102	9.4894	2.822	3	9.0566	3.264	3.47
1/4	5.786	12.4867	4.234	3	11.861	4.897	3.47
3/8	6.096	15.9261	4.234	3	15.2806	4.897	3.47
1/2	8.128	19.7721	5.443	3	18.924	6.294	3.47
3/4	8.611	25.1173	5.443	3	24.239	6.294	3.47
1	10.16	31.4612	6.627	3	30.4122	7.663	3.47
1 1/4	10.668	40.2179	6.627	3	39.1371	7.663	3.47
1 1/2	10.668	46.2874	6.627	3	45.2064	7.663	3.47
2	11.074	58.3253	6.627	3	57.2191	7.663	3.47
2 1/2	17.323	70.1589	6.35	2	68.6793	11.016	3.47
3	19.456	86.0679	6.35	2	84.455	11.016	3.47
3 1/2	20.853	98.7758	6.35	2	97.0758	11.016	3.47
4	21.438	111.4328	6.35	2	109.6962	11.016	3.47
5	23.80	138.412	6.35	2	136.5278	11.016	3.47
6	24.333	165.2516	6.35	2	163.3339	11.016	3.47
8	27.00	215.9008	6.35	2	213.8164	11.016	3.47
10	30.734	269.7719	6.35	2	267.4541	11.016	3.47
12	34.544	320.4924	6.35	2	317.9366	11.016	3.47

7.1 Pipes, flanges, pipe bends, threads

USA standard: tapered pipe thread NPT
ANSI B1.20.1

Rated size of the pipe	Total length of the male thread	Rated length of the fully cut-out thread		Depth of thread	Diameter increase per thread	Core diameter bore width at pipe end
		Length	Screw thread diameter			
	L ₄	L ₅	E ₅	h	$\frac{0.0625}{n}$	K ₀
-	mm	mm	mm	mm	-	mm
Inch	mm	mm	mm	mm	-	mm
1/16	9.896	4.75	7.1849	0.753	0.059	6.137
1/8	9.967	4.821	9.5344	0.753	0.059	8.481
1/4	15.103	7.384	12.5872	1.129	0.088	10.996
3/8	15.255	7.536	16.0162	1.129	0.088	14.417
1/2	19.85	9.929	19.8846	1.451	0.113	17.813
3/4	20.155	10.234	25.2186	1.451	0.113	23.127
1	25.006	12.924	31.6339	1.767	0.138	29.060
1 1/4	25.616	13.536	40.3969	1.767	0.138	37.785
1 1/2	26.040	13.96	46.4929	1.767	0.138	43.853
2	26.878	14.798	58.5579	1.767	0.138	55.867
2 1/2	39.908	22.524	70.485	2.54	0.198	66.535
3	41.496	24.13	86.36	2.54	0.198	82.311
3 1/2	42.766	25.40	99.06	2.54	0.198	94.932
4	44.036	26.67	111.76	2.54	0.198	107.554
5	46.736	29.37	138.7602	2.54	0.198	134.384
6	49.433	32.068	165.735	2.54	0.198	161.191
8	54.513	37.148	216.535	2.54	0.198	211.673
10	59.911	42.545	270.51	2.54	0.198	265.311
12	64.991	47.625	321.31	2.54	0.198	315.793

7.2 Material datasheets

Designations, available types, temperature limits

Material group	Material no. to DIN EN 10 027	Short name to DIN EN 10 027	Short name to DIN (old)	Semi-finished product	Documentation	Documentation old	Upper temp. limit °C
Unalloyed steel	1.0254	P235TR1	St 37.0	Welded tube Seamless tube	DIN EN 10217-1 DIN EN 10216-1	DIN 1626 DIN 1629	300
	1.0255	P235TR2	St 37.4	Welded tube Seamless tube	DIN EN 10217-1 DIN EN 10216-1		
	1.0427	C22G1	C 22.3	Flanges	VdTÜV-W 364		350
Common structural steel	1.0038	S235JRG2	RSt 37-2	Steel bar, flat products, wire rod, profiles	DIN EN 10025 ADW1		300
	1.0050	E295	St 50-2				
	1.0570	S355J2G3	St 52-3				
Heat resistant unalloyed steel	1.0460	C22G2	C 22.8	Flanges	VdTÜVW 350		450
Heat resistant steel	1.0345	P235GH	HI	Sheet	DIN EN 10028	DIN 17155	480
				Seamless tube	DIN EN 10216		450
	1.0425	P265GH	HI1	Sheet	DIN EN 10028	DIN 17155	480
	1.0481	P295GH	17 Mn 4	Sheet	DIN EN 10028	DIN 17155	500
				Seamless tube	DIN 17175		
	1.5415	16Mo3	15 Mo 3	Sheet	DIN EN 10028	DIN 17155	530
				Seamless tube	DIN 17175		
1.7335	13CrMo4-5	13CrMo4-4	Sheet	DIN EN 10028	DIN 17155	570	
1.7380	10CrMo9-10	10 CrMo 9 10	Sheet	DIN EN 10028	DIN 17155	600	
			Seamless tube	DIN 17175			
1.0305	P235G1TH	St 35.8	Seamless tube	DIN 17175		480	
Fine-grained structural steel Standard	1.0562	P355N	StE 355	Sheet	DIN EN 10028	DIN 17102	
heat resist.	1.0565	P355NH	WStE 355	Strip			400
cold resist.	1.0566	P355NL1	TStE 355	Steel bar			(-50) ¹⁾
special	1.1106	P355NL2	ESStE 355				(-60) ¹⁾

1) Cold resistant limit

7.2 Material datasheets

Strength values at room temperature (RT)

(guaranteed values ¹⁾)

Material no. to DIN EN 10 027	Yield point min. R _{eH} N/mm ²	Tensile strength R _m N/mm ²	Breaking elongation, min.		Notched bar impact strength min. A _K (KV ²) J	Remarks
			A ₅ %	A ₉₀ %		
1.0254	235	360-500	23			s ≤ 16
1.0255	235	360-500	23		at 0 °C: 27	s ≤ 16
1.0427	240	410-540	20 (transverse)		at RT: 31	s ≤ 70
1.0038	235	340-470	21-26 ¹⁾	17-21 ³⁾	at RT: 27	3 ≤ s ≤ 100 (R _m)
1.0050	295	470-610	16-20 ¹⁾	12-16 ³⁾		10 ≤ s ≤ 150 (KV)
1.0570	355	490-630	18-22 ¹⁾	14-18 ³⁾	at -20 °C: 27	s < 16 (R _{SH})
1.0460	240	410-540	20		at RT: 31	s ≤ 70
1.0345	235	360-480	25		at 0 °C: 27	s ≤ 16
	235	360-500	23		at 0 °C: 27	s ≤ 16
1.0425	265	410-530	23		at 0 °C: 27	s ≤ 16
1.0481	295	460-580	22		at 0 °C: 27	s ≤ 16
	270					
1.5415	275	440-590	24		at RT: 31	s ≤ 16
	270					
1.7335	300	440-600	20		at RT: 31	s ≤ 16
	290					
1.7380	310	480-630	18		at RT: 31	s ≤ 16
	280					
1.0305	235	360-480	23		at RT: 34	s ≤ 16
1.0562	355	490-630	22		at 0 °C: 47	s ≤ 16
1.0565					at 0 °C: 47	s ≤ 16
1.0566					at 0 °C: 55	s ≤ 16
1.1106					at 0 °C: 90	s ≤ 16

1) Smallest value of longitudinal or transverse test

2) New designation to DIN EN 10045; average of 3 specimens in DIN EN standards

3) Dependent on product thickness

7.2 Material datasheets

Designations, available types, temperature limits

Material group	Material no. to DIN EN 10 027	Short name to DIN EN 10 027	Semi-finished product	Documentation	Documentation old	Upper temp. limit °C
Stainless ferritic steel	1.4511	X3CrNb17	Strip	DIN EN 10088 VdTÜV-W422	DIN 17441 ²⁾	200 as per VdTÜV
	1.4512	X2CrTi12	Strip	DIN EN 10088 SEW 400		350
Stainless austenitic steel	1.4301	X5CrNi18-10	Strip Strip Sheet	DIN EN 10088	DIN 17441/97 DIN 17440/96	550 / 300 ¹⁾
	1.4306	X2CrNi19-11	Strip Strip Sheet	DIN EN 10088	DIN 17441/97 DIN 17440/96	550 / 350 ¹⁾
	1.4541	X6CrNiTi18-10	Strip Strip Sheet	DIN EN 10088	DIN 17441/97 DIN 17440/96	550 / 400 ¹⁾
	1.4571	X6CrNiMoTi17-12-2	Strip Strip Sheet	DIN EN 10088	DIN 17441/97 DIN 17440/96	550 / 400 ¹⁾
	1.4404	X2CrNiMo17-12-2	Strip Strip Sheet	DIN EN 10088	DIN 17441/97 DIN 17440/96	550 / 400 ¹⁾
	1.4435	X2CrNiMo18-14-3	Strip Strip Sheet	DIN EN 10088	DIN 17441/97 DIN 17440/96	550 / 400 ¹⁾
	1.4565	X2CrNiMnMoNbN25-18-5-4	Strip, Strip Sheet	SEW 400 / 97	SEW 400 / 91	550 / 400 ¹⁾
	1.4539	X1NiCrMoCu25-20-5	Strip Sheet, Strip	DIN EN 10088		550 / 400 ¹⁾
			Seamless tube	VdTÜV-W421		400
	1.4529	X1NiCrMoCuN25-20-7	Strip Sheet, Strip Seamless tube	DIN EN 10088		400
				VdTÜV-W 502		
Austenitic steel of high heat resistance	1.4948	X6CrNi18-10	Strip Sheet strip Forgin Seamless tube	DIN EN 10028-7 DIN EN 10222-5	DIN 17460 DIN 17460	600 600 600
	1.4919	X6CrNiMo17-13	Sheet, strip, bar Forging	DIN 17460		600
			Seamless tube	DIN 17459		600
	1.4958	X5NiCrAlTi31-20	Sheet, strip, bar Forging	DIN 17460		600
			Seamless tube	DIN 17459		600

1) Temperature limit where risk of intercrystalline corrosion

2) Earlier standard DIN 17441 7/85

7.2 Material datasheets

Strength values at room temperature (RT)

(guaranteed values ³⁾)

Material no. to DIN EN 10 027	Yield points min.		Tensile strength R_m N/mm ²	Breaking elongation, min.		Notched bar impact strength > 10 mm thickness, transverse min. KV in J	Remarks
	$R_{p0.2}$ N/mm ²	$R_{p1.0}$ N/mm ²		> 3 mm thickness A_5 %	< 3 mm thickness A_{30} %		
1.4511	230		420-600		23		s ≤ 6
1.4512	210		380-560		25		s ≤ 6
1.4301	t	230	540-750	45	45	at RT: 60	s ≤ 6
	l	215		43	40		
1.4306	t	220	520-670	45	45	at RT: 60	s ≤ 6
	l	205		43	40		
1.4541	t	220	520-720	40	40	at RT: 60	s ≤ 6
	l	205		38	35		
1.4571	t	240	540-690	40	40	at RT: 60	s ≤ 6
	l	225		38	35		
1.4404	t	240	530-680	40	40	at RT: 60	s ≤ 6
	l	225		38	35		
1.4435	t	240	550-700	40	40	at RT: 60	s ≤ 6
	l	225		38	35		
1.4565	t	420	800-1000	30	25	at RT: 55	s ≤ 30
1.4539	t	240	530-730	35	35	at RT: 60	s ≤ 6
	l	225		33	30		
1.4529		220	520-720	40	40		
	t	300	650-850	40	40	at RT: 60	s ≤ 75
	l	285	325	38	35		
	300	340	600-800	40	40	at RT: 84	
1.4948	t	230	530-740	45	45	at RT: 60	s ≤ 6
	t	195	490-690	35		at RT: 60	s ≤ 250
	t	185	500-700	30		at RT: 60	
1.4919		205	490-690	35	30	at RT: 60	
		205	490-690	30		at RT: 60	
1.4958		170	500-750	35	30	at RT: 80	
		170	500-750	35		at RT: 80	s ≤ 50

3) Smallest value of longitudinal or transverse test, q = tensile test, transverse, l = tensile test, longitudinal

7.2 Material datasheets

Designations, available types, temperature limits

Material group	Material no. to DIN EN 10 027 ¹⁾	Short name to DIN EN 10 027	Trade name	Semi-finished product	Documentation	Upper temp. limit °C
Heat resistant steel	1.4828	X15CrNiSi20-12		Strip Sheet, Strip,	DIN EN 10095 (SEW470)	900
	1.4876	X10NiCrAlTi32-21	INCOLOY 800	Strip Sheet, Strip all	SEW470 VdTÜV-W412	600
		X10NiCrAlTi32-21 H	INCOLOY 800 H	Strip Sheet, Strip all	VdTÜV-W434 DIN EN 10095	950 900
Nickel-based alloys	2.4858	NiCr21Mo	INCOLOY 825	all Strip Sheet, Strip	DIN 17750/02 VdTÜV-W432 DIN 17744 ²⁾	450
	2.4816	NiCr15Fe	INCONEL 600	Strip Sheet, Strip	DIN EN 10095 DIN 17750/02	1000
			INCONEL 600 H		VdTÜV-W305 DIN 17742 ²⁾	450
	2.4819	NiMo16Cr15W	HASTELLOY C-276	Strip Sheet, Strip	DIN 17750/02 VdTÜV-W400 DIN 17744 ²⁾	450
	2.4856	NiCr22Mo9Nb	INCONEL 625	Flat products Strip Sheet, Strip	DIN EN 10095 DIN 17750/02	900 450
			INCONEL 625 H	(VdTÜV-W499) DIN 17744 ²⁾		
	2.4610	NiMo16Cr16Ti	HASTELLOY-C4	Strip Sheet, Strip Strip Sheet, Strip	DIN 17750/02 VdTÜV-W424 DIN 17744 ²⁾	400
2.4360	NiCu30Fe	MONEL	Strip, Strip Sheet	DIN 17750/02 VdTÜV-W 263	425	
			Seamless tube Forging	DIN 17743 ²⁾		

1) In the case of nickel-based alloys, DIN 17007 governs the material number

2) Chemical composition

7.2 Material datasheets

Strength values at room temperature (RT)

(guaranteed values ³⁾)

Material no. to DIN EN 10 027 ¹⁾	Yield points min.		Tensile strength R_m N/mm ²	Breaking elongation, min.		Notched bar impact strength min. KV J	Remarks
	$R_{p0.2}$ N/mm ²	$R_{p1.0}$ N/mm ²		A_5 %	A_{80} %		
1.4828	230	270	500-750				s ≤ 3 mm solution annealed
1.4876 INCOLOY 800 (1.4876 H)	170	210	450-680	22			Soft annealed
	210	240	500-750	30		at RT: 150 ⁴⁾	
INCOLOY 800H	170	200	450-700	30			solution annealed (AT)
	170	210	450-680		28		
2.4858 INCOLOY 825	240	270	≥ 550	30			Soft annealed
	235	265	550-750			at RT: 80	s ≤ 30 mm
2.4816 INCONEL 600 INCONEL 600 H	240		500-850				Annealed (+A)
	180	210	≥ 550		28		solution annealed (F50)
	200	230	550-750	30		at RT: 150 ⁴⁾	Soft annealed
INCONEL 600 H	180	210	500-700	35	30	at RT: 150 ⁴⁾	solution annealed
	310	330	≥ 690	30			s ≤ 5 mm, solution annealed (F69)
2.4819 HASTELLOY C-276	310	330	730-1000	30	30	at RT: 96	
	310	330		30	30		
2.4856 INCONEL 625 H INCONEL 625	415		820-1050				s ≤ 3 mm, Annealed (+A)
	275	305	≥ 690			at RT: 100	solution annealed (F69)
	400	440	830-1000	30			s ≤ 3 mm; Soft annealed
2.4610 HASTELLOY-C4	305	340	≥ 690	40		at RT: 96	s ≤ 5, solution annealed
	280	315	700-900	40	30	at RT: 96	5 < s ≤ 30
2.4360 MONEL	175	205	≥ 450	30			s ≤ 50, Soft annealed
	175		450-600	30		at RT: 120	Soft annealed

3) Smallest value of longitudinal or transverse test

4) Value a_k in J/cm²

7.2 Material datasheets

Designations, available types, temperature limits

Material group	Material designation				Semi-finished product	Documentation	Documentation old	Upper temp. limit °C
	DIN EN 1652 (new) Number	Short name	DIN 17670 (old) Number	Short name				
Copper-based alloy	CW354H	CuNi30Mn1Fe	2.0882	CuNi30Mn1Fe CUNIFER 30 ¹⁾	Strip, Strip Sheet	DIN-EN 1652 AD-W 6/2	DIN 17664 DIN 17670	350
Copper	CW024A	Cu-DHP	2.0090	SF-Cu	Strip, Strip Sheet	DIN-EN 1652 AD-W 6/2	DIN 1787 DIN 17670	250
Copper-tin alloy	CW452K	CuSn6	2.1020	CuSn6 Bronze	Strip, Strip Sheet	DIN-EN 1652	DIN 17662 DIN 17670	
Copper-zinc-alloy	CW503L	CuZn20	2.0250	CuZn 20	Strip, Strip Sheet	DIN-EN 1652	DIN 17660 DIN 17670	
	CW508L	CuZn37	2.0321	CuZn 37 Brass	Strip, Strip Sheet	DIN-EN 1652	DIN 17660 DIN 17670	
			2.0402	CuZn40Pb2	Strip, Strip Sheet	DIN 17670 DIN 17660		
Wrought aluminium alloy	DIN EN 485-2 (new)		DIN 1745-1 (old)		Semi-finished product	Documentation	Documentation old	Upper temp. limit °C
	Number	Short name	Number	Short name				
Wrought aluminium alloy	EN AW-5754	EN AW-Al Mg3	3.3535	AlMg 3	Strip, Strip Sheet	DIN EN 485-2 DIN EN 575-3 AD-W 6/1	DIN 1745 DIN 1725	
	EN AW-6082	EN AW-AISiMgMn	3.2315	AlMgSi 1	Strip, Strip Sheet	DIN-EN 485-2 DIN-EN 573-3	DIN 1745 DIN 1725	150 (AD-W)
Pure nickel	2.4068	LC-Ni 99		LC-Ni 99	Strip, Strip	VdTÜV-W 345		600
Titanium	3.7025	Ti 1		Ti 1	Sheet	DIN 17 850		250
					Strip, Strip Sheet	DIN 17 860 VdTÜV-W 230		
Tantalum		Ta		Ta	Strip, Strip Sheet	VdTÜV-W382		250

1) Trade name

7.2 Material datasheets

Strength values at room temperature (RT)

(guaranteed values ²⁾)

Material no.	Yield points min.		Tensile strength	Breaking elongation, min.	Notched bar impact strength min. KV J	Remarks
	R _{0,2} N/mm ²	R _{p1,0} N/mm ²	R _m N/mm ²	A ₅ %		
CW354H 2.0882	≥ 120		350-420	35 ⁶⁾		R350 (F35) ⁴⁾ 0.3 ≤ s ≤ 15
CW024A 2.0090	≤ 100		200-250	42 ⁶⁾		R200 (F20) ⁴⁾ s > 5 mm
	≤ 140		220-260	33 ⁷⁾ / 42 ⁶⁾		R220 (F22) ⁴⁾ 0.2 ≤ s ≤ 5 mm
CW452K 2.1020	≤ 300		350-420	45 ⁷⁾		R350 (F35) ⁴⁾ 0.1 ≤ s ≤ 5 mm
				55 ⁶⁾		
CW503L 2.0250	≤ 150		270-320	38 ⁷⁾		R270 (F27) ⁴⁾ 0.2 ≤ s ≤ 5 mm
				48 ⁶⁾		
CW508L 2.0321	≤ 180		300-370	38 ⁷⁾		R300 (F30) ⁴⁾ 0.2 ≤ s ≤ 5 mm
				48 ⁶⁾		
2.0402	≤ 300		≥ 380	35		(F38) ⁵⁾ 0.3 ≤ s ≤ 5 mm
Material no.	Yield points min.		Tensile strength	Breaking elongation, min.	Notched bar impact strength-min. KV J	Remarks
	R _{0,2} N/mm ²	R _{p1,0} N/mm ²	R _m N/mm ²	A ₅ %		
EN AW-5754 3.3535	≥ 80		190-240	14 (A50)		0.5 < s ≤ 1.5 mm State: O / H111 DIN EN values
EN AW-6082 3.2315	≤ 85		≤ 150	14 (A50)		0.4 ≤ s ≤ 1.5 mm State: O ; DIN EN values
	≥ 80	≥ 105	340-540	40		
3.7025	≥ 180	≥ 200	290-410	30 / 24 ⁸⁾	62	0.4 < s ≤ 8 mm
TANTAL - ES	≥ 140		≥ 225	35 ³⁾		0.1 ≤ s ≤ 5.0 Electron beam melted Sintered in vacuum
TANTAL - GS	≥ 200		≥ 280	30 ³⁾		

2) Smallest value of longitudinal or transverse test

3) Measured length l₀ = 25 mm

4) State designation to DIN EN 1652 or. (-) to DIN

5) To DIN, material not contained in the DIN EN

6) Specification in DIN EN for s > 2.5 mm

7) Breaking elongation A₅₀, specification

in DIN EN for s ≤ 2.5 mm

8) A₅₀ for thickness ≤ 5 mm

7.2 Material datasheets

Chemical composition

(percentage by mass)

Material group	Material No.	Short name	C ¹⁾	Si Max.	Mn	P Max.	S Max.	Cr	Mo	Ni	Other elements
Unalloyed steel	1.0254	P235TR1	≤ 0.16	0.35	≤ 1.20	0.025	0.020	≤ 0.30	≤ 0.08	≤ 0.30	Cu ≤ 0.30 Cr+Cu+Mo+Ni ≤ 0.70
	1.0255	P235TR2	≤ 0.16	0.35	≤ 1.20	0.025	0.020	≤ 0.30	≤ 0.08	≤ 0.30	Cu ≤ 0.30 Cr+Cu+Mo+Ni ≤ 0.70 Al _{tot} ≥ 0.02
	1.0427	C22G1	0.18 - 0.23	0.15 - 0.35	0.40 - 0.90	0.035	0.030	≤ 0.30			Al _{tot} ≥ 0.015
Common structural steel	1.0038	S235JRG2	≤ 0.17		≤ 1.40	0.045	0.045				N ≤ 0.009
	1.0050	E295				0.045	0.045				N ≤ 0.009
	1.0570	S355J2G3	≤ 0.20	0.55	1.60	0.035	0.035				Al _{tot} ≥ 0.015
Heat resist. unalloyed steel	1.0460	C22G2	0.18 - 0.23	0.15 - 0.35	0.40 - 0.90	0.035	0.030	≤ 0.30			
Heat resistant steel	1.0345	P235GH	≤ 0.16	0.35	0.40 - 1.20	0.030	0.025	≤ 0.30	≤ 0.08	≤ 0.30	Nb, Ti, V Al _{tot} ≥ 0.020 Cu ≤ 0.30
	1.0425	P265GH	≤ 0.20	0.40	0.50	0.030	0.025	≤ 0.30	≤ 0.08	≤ 0.30	
	1.0481	P295GH	0.08 - 0.20	0.40	0.90 - 1.50	0.030	0.025	≤ 0.30	≤ 0.08	≤ 0.30	Cr+Cu+Mo+Ni ≤ 0.70
	1.5415	16Mo3	0.12 - 0.20	0.35	0.40 - 0.90	0.030	0.025	≤ 0.30	0.25 - 0.35	≤ 0.30	Cu ≤ 0.3
	1.7335	13CrMo4-5	0.08 - 0.18	0.35	0.40 - 1.00	0.030	0.025	0.70 - 1.15	0.40 - 0.60		Cu ≤ 0.3
	1.7380	10 CrMo9-10	0.08 - 0.14	0.50	0.40 - 0.80	0.030	0.025	2.00 - 2.50	0.90 - 1.10		Cu ≤ 0.3
	1.0305	P235G1TH	≤ 0.17	0.10 - 0.35	0.40 - 0.80	0.040	0.040				

1) Carbon content dependent on thickness. Values are for a thickness of ≤ 16 mm.

7.2 Material datasheets

Chemical composition

(percentage by mass)

Material group	Material No.	Designation	C Max.	Si Max.	Mn	P Max.	S Max.	Cr	Mo	Ni	Other elements
Fine-grained structural steel	1.0562	P355N	0.20	0.50	0.9 - 1.7	0.030	0.025	≤ 0.3	≤ 0.8	≤ 0.5	Al _{tot} ≥ 0.020 (see DIN EN 10028-3)
	1.0565	P355NH	0.20	0.50	0.9 - 1.7	0.030	0.025	≤ 0.3	≤ 0.8	≤ 0.5	Cu, N, Nb, Ti, V
	1.0566	P355NL1	0.18	0.50	0.9 - 1.7	0.030	0.020	≤ 0.3	≤ 0.8	≤ 0.5	Nb + Ti + V ≤ 0.12
	1.1106	P355NL2	0.18	0.50	0.9 - 1.7	0.025	0.015	≤ 0.3	≤ 0.8	≤ 0.5	
Stainless ferritic steel	1.4511	X3CrNb17	0.05	1.00	≤ 1.0	0.040	0.015	16.0 - 18.0			Nb: 12 x % C - 1.00
	1.4512	X2CrTi12	0.03	1.00	≤ 1.0	0.040	0.015	10.5 - 12.5			Ti: 6 x (C+N) - 0.65
Stainless austenitic steel	1.4301	X5CrNi18-10	0.07	1.00	≤ 2.0	0.045	0.015	17.0 - 19.5		8.0 - 10.5	
	1.4306	X2CrNi19-11	0.03	1.00	≤ 2.0	0.045	0.015	18.0 - 20.0		10.0 - 12.0	
	1.4541	X6CrNiTi18-10	0.08	1.00	≤ 2.0	0.045	0.015	17.0 - 19.0		9.0 - 12.0	Ti: 5 x % C - 0.7
	1.4571	X6CrNiMoTi17 12 2	0.08	1.00	≤ 2.0	0.045	0.015	16.5 - 18.5	2.0 - 2.5	10.5 - 13.5	Ti: 5 x % C - 0.7
	1.4404	X2CrNiMo17 12 2	0.03	1.00	≤ 2.0	0.045	0.015	16.5 - 18.5	2.0 - 2.5	10.0 - 13.0	N ≤ 0.11
	1.4435	X2CrNiMo18 14 3	0.03	1.00	≤ 2.0	0.045	0.015	17.0 - 19.0	2.5 - 3.0	12.5 - 15.0	
	1.4565	X2CrNiMoNb25 18 5 4	0.04	1.00	4.5 - 6.5	0.030	0.015	21.0 - 25.0	3.0 - 4.5	15.0 - 18.0	Nb ≤ 0.30, N: 0.04 - 0.15
	1.4539	X1NiCrMoCu25-20-5	0.02	0.70	≤ 2.0	0.030	0.010	19.0 - 21.0	4.0 - 5.0	24.0 - 26.0	Cu, N: ≤ 0.15
	1.4529	X2NiCrMoCuN25-20-7	0.02	0.50	≤ 1.0	0.030	0.010	19.0 - 21.0	6.0 - 7.0	24.0 - 26.0	Cu: 0.5 - 1 N: 0.15 - 0.25

7.2 Material datasheets

Chemical composition

(percentage by mass)

Material group	Material No.	Short name Trade name	C	Si	Mn	P Max.	S Max.	Cr	Mo	Ni	Other elements
Austenitic steel of high heat resistance	1.4948	X6CrNi18-10	0.04 - 0.08	≤ 1.00	≤ 2.0	0.035	0.015	17.0 - 19.0		8.0 - 11.0	
	1.4919	X6CrNiMo 17-13	0.04 - 0.08	≤ 0.75	≤ 2.0	0.035	0.015	16.0 - 18.0	2.0 - 2.5	12.0 - 14.0	
Heat resistant steel	1.4828	X15CrNiSi 20-12	≤ 0.20	1.50 - 2.00	≤ 2.0	0.045	0.015	19.0 - 21.0		11.0 - 13.0	N: max 0.11
	1.4876 (DIN EN 10095)	X10NiCrAlTi32-21 INCOLOY 800H	≤ 0.12	≤ 1.00	≤ 2.0	0.030	0.015	19.0 - 23.0		30.0 - 34.0	Al: 0.15 - 0.60 Ti: 0.15 - 0.60
Nickel-based alloy	2.4858	NiCr21Mo INCOLOY 825	≤ 0.025	≤ 0.50	≤ 1.0	0.020	0.015	19.5 - 23.5	2.5 - 3.5	38.0 - 46.0	Ti, Cu, Al, Co ≤ 1.0
	2.4816	NiCr15Fe INCONEL 600 INCONEL 600 H	0.05 - 0.10	≤ 0.50	≤ 1.0	0.020	0.015	14.0 - 17.0		> 72	Ti, Cu, Al
	2.4819	NiMo16Cr15W HASTELLOY C-276	≤ 0.01	0.08	≤ 1.0	0.020	0.015	14.5 - 16.5	15.0 - 17.0	Re- mainder	V, Co, Cu, Fe
	2.4856	NiCr22Mo9Nb INCONEL 625 INCONEL 625 H	0.03 - 0.10	≤ 0.50	≤ 0.5	0.020	0.015	20.0 - 23.0	8.0 - 10.0	> 58	Ti, Cu, Al Nb/Ta: 3.15 - 4.15 Co ≤ 1.0
	2.4610	NiMo16Cr16Ti HASTELLOY C4	≤ 0.015	≤ 0.08	≤ 1.0	0.025	0.015	14.0 - 18.0	14.0 - 17.0	Re- mainder	Ti, Cu, Co ≤ 2.0
	2.4360	NiCu30Fe MONEL	≤ 0.15	≤ 0.50	≤ 2.0		0.020				> 63
Copper-based alloy	2.0882	CuNi 30 Mn1 Fe CUNIFER 30	≤ 0.05		0.5 - 1.5		0.050			30.0 - 32.0	Cu: residue, Pb, Zn

7.2 Material datasheets

Chemical composition

(percentage by mass)

material group	Material no.	Short name	Cu	Al	Zn	Sn	Pb	Ni	Ti	Ta	Other elements
Copper	CW024A (2.0090)	Cu DHP (SF-Cu)	≥ 99.9								P: 0.015 - 0.04
Copper-tin alloy	CW452K (2.1020)	CuSn 6 Bronze	Rest		≤ 0.2	5.5 - 7.0	≤ 0.20	≤ 0.2			P: 0.01 - 0.4 Fe: ≤ 0.1
Copper-zinc alloy	CW503L 2.0250	CuZn 20	79.0 - 81.0	≤ 0.02	Re- mainder	≤ 0.1	≤ 0.05				
	CW508L (2.0321)	CuZn 37 Brass	62.0 - 64.0	≤ 0.05	Re- mainder	≤ 0.1	≤ 0.10	≤ 0.3			
	2.0402	CuZn 40 Pb 2	57.0 - 59.0	≤ 0.1	Re- mainder	≤ 0.3	1.50 - 2.50	≤ 0.4			
Wrought aluminium alloy	EN AW-5754 (3.3535)	EN AW-Al Mg3	≤ 0.1	Re- mainder	≤ 0.1				≤ 0.15		Si, Mn, Mg
	EN AW-6082 (3.2315)	EN AW-Al Si1MgMn	≤ 0.1	Re- mainder	≤ 0.2				≤ 0.1		Si, Mn, Mg
Pure nickel	2.4068	LC-Ni 99	≤ 0.025					≥ 99	≤ 0.1		C ≤ 0.02 Mg ≤ 0.15 S ≤ 0.01 Si ≤ 0.2
Titanium	3.7025	Ti							Re- mainder		N ≤ 0.05 H ≤ 0.013 C ≤ 0.06 Fe ≤ 0.15
Tantalum	-	Ta						≤ 0.01	≤ 0.01	Rem.	

7.2 Material datasheets

Strength values at elevated temperatures

Material no. to DIN	Type of value	Material strength values in N/mm ²																
		Temperatures in °C																
		RT ¹⁾	100	150	200	250	300	350	400	450	500	550	600	700	800			
1.0254	R _{p0.2}	235																
1.0255	R _{0.2}	235																
1.0427	R _{p0.2}	220	210	190	170	150	130	110										
1.0038	R _{p0.2}	205	187		161	143	122	(values to AD W1)										
1.0570	R _{p0.2}	315	254		226	206	186											
1.0460	R _{p0.2}	240	230	210	185	165	145	125	100	80								
	R _{p1/100000}								136	80	(53)	() = values at 480 °C						
	R _{p1/1000000}								95	49	(30)							
	R _{m10000}								191	113	(75)							
	R _{m100000}								132	69	(42)							
R _{m200000}																		
1.0345	R _{p0.2}	206	190	180	170	150	130	120	110	80	(53)	() = values at 480 °C						
	R _{p1/100000}								136	80	(30)							
	R _{p1/1000000}								95	49	(30)							
	R _{m10000}								191	113	(75)							
	R _{m100000}								132	69	(42)							
1.0425	R _{p0.2}	234	215	205	195	175	155	140	130	80	(53)	() = values at 480 °C						
	R _{p1/100000}								136	80	(30)							
	R _{p1/1000000}								95	49	(30)							
	R _{m10000}								191	113	(75)							
	R _{m100000}								132	69	(42)							
1.0481	R _{p0.2}	272	250	235	225	205	185	170	155	93	49	() = values at 530 °C						
	R _{p1/100000}								167	59	29							
	R _{p1/1000000}								118	59	29							
	R _{m10000}								243	143	74							
	R _{m100000}								179	85	41							
1.5415	R _{p0.2}	275			215	200	170	160	150	145	140	(84)	() = values at 530 °C					
	R _{p1/100000}								216	132	(36)							
	R _{p1/1000000}								167	73	(102)							
	R _{m10000}								298	171	(102)							
	R _{m100000}								239	101	(53)							
1.7335	R _{p0.2}				230	220	205	190	180	170	165	() = values at 570 °C						
	R _{p1/100000}								245	157	(53)							
	R _{p1/1000000}								191	98	(24)							
	R _{m10000}								370	239	(76)							
	R _{m100000}								285	137	(33)							

7.2 Material datasheets

Strength values at elevated temperatures

Material no. to DIN	Type of value	Material strength values in N/mm ²															
		Temperatures in °C															
		RT ¹⁾	100	150	200	250	300	350	400	450	500	550	600	700	800		
1.7380	R _{p0.2}																
	R _{p1/100000}									245	230	220	210	200	190	180	
	R _{p1/1000000}														240	147	
	R _{m10000}														166	103	
	R _{m100000}														306	196	
	R _{m200000}														221	135	
1.0305	R _{p0.2}	235															
	R _{p1/100000}									185	165	140	120	110	105		
	R _{p1/1000000}														136	80	
	R _{m10000}														95	49	
	R _{m100000}														191	113	
	R _{m200000}														132	69	
1.0565	R _{p0.2}	336	304	284	245	226	216	196	167								
1.4511	R _{p0.2}	230	230	220	205	190	180	165									
1.4512	R _{p0.2}	210	200	195	190	186	180	160									
1.4301	R _{p0.2}	215	157	142	127	118	110	104	98	95	92	90					
	R _{p1}		191	172	157	145	135	129	125	122	120	120	(approx. values to DIN 17441)				
	R _{m10000}												122	48	(17)		
	R _{m100000}												74	23	(5)		
1.4306	R _{p0.2}	205	147	132	118	108	100	94	89	85	81	80					
	R _{p1}		181	162	147	137	127	121	116	112	109	108					
	R _{m10000}																
1.4541	R _{p0.2}	205	176	167	157	147	136	130	125	121	119	118					
	R _{p1}		208	196	186	177	167	161	156	152	149	147	(approx. values to DIN 17441)				
	R _{m10000}												115	45	(17)		
	R _{m100000}												65	22	(8)		
1.4571	R _{p0.2}	225	185	177	167	157	145	140	135	131	129	127					
	R _{p1}		218	206	196	186	175	169	164	160	158	157					
1.4404	R _{p0.2}	225	166	152	137	127	118	113	108	103	100	98					
	R _{p1}		199	181	167	157	145	139	135	130	128	127					
1.4435	R _{p0.2}	225	165	150	137	127	119	113	108	103	100	98					
	R _{p1}		200	180	165	153	145	139	135	130	128	127					
1.4565	R _{p0.2}	420	350	310	270	255	240	225	210	210	210	200					
	R _{p1}	460	400	355	310	290	270	255	240	240	240	230					
1.4539	R _{p0.2}	220	205	190	175	160	145	135	125	115	110	105					
	R _{p1}		235	220	205	190	175	165	155	145	140	135					
	R _{m (vdTOV)}	520	440	420	400	390	380	370	360								
1.4529	R _{p0.2}	300	230	210	190	180	170	165	160								
	R _{p1}	340	270	245	225	215	205	195	190								

1) Room temperature values valid to 50 °C

7.2 Material datasheets

Material no. to DIN	Type of value	Material strength values in N/mm ²															
		Temperatures in °C															
		RT ¹⁾	100	150	200	250	300	350	400	450	500	550	600	700	800	900	
1.4948	R _{p0.2}	230	157	142	127	117	108	103	98	93	88	83	78				
	R _{p1}	260	191	172	157	147	137	132	127	122	118	113	108				
	R _m	530	440	410	390	385	375	375	370	360	330	300					
	R _{p1/100000}									147	121	94	35				
	R _{p1/1000000}									114	96	74	22				
	R _{m10000}									250	191	132	55				
	R _{m100000}									192	140	89	28				
R _{m200000}									176	125	78	22					
1.4919	R _{p0.2}	205	177		147		127		118		108	103	98				
	R _{p1}	245	211		177		157		147		137	132	128				
	R _{p1/100000}											180	125	46			
	R _{p1/1000000}											125	85	25			
	R _{m10000}											250	175	65			
	R _{m100000}											175	120	34			
	R _{m200000}																
1.4828 DIN EN 10095	R _{p0.2}	230	332		318		300		279		253		218	(Manufacturer's figures)			
	R _m	550	653		632		600		550		489		421				
	R _{p1/1000}											120	50	20	8		
	R _{p1/100000}											80	25	10	4		
	R _{m1000}											190	75	35	15		
	R _{m10000}											120	36	18	8.5		
	R _{m100000}											65	16	7.5	3.0		
1.4876 DIN EN 10095 Incoloy 800H	R _{p0.2}	170	185	170	160	150	145		130		125	120	115	(Manufacturer's figures)			
	R _{p1}	210	205	190	180	170	165		150		145	140	135				
	R _m	450	425		400		390		380		360		300				
	R _{p1/1000}											130	70	30	13		
	R _{p1/100000}											90	40	15	5		
	R _{m1000}											200	90	45	20		
	R _{m100000}											152	68	30	10		
2.4858	R _{p0.2}	235	205	190	180	175	170	165	160	155							
	R _{p1}	265	235	220	205	200	195	190	185	180							
	R _m	550	530		515		500		490	485							
2.4816 DIN EN 10095	R _{p0.2}	200	180		165		155		150	145				(Soft annealed)			
	R _m	550	520		500		485		480	475							
	R _{p0.2}	180	170		160		150		150	145				(solution annealed)			
	R _m	500	480		460		445		440	435							
	R _{p1/100000}										153		91	43	18	8	
	R _{m100000}										126		66	28	12	4	
R _{m1000}												160	96	38	22		
R _{m10000}												297	138	63	29	13	
R _{m100000}												215	97	42	17	7	

1) Room temperature values valid to 50 °C

7.2 Material datasheets

Material no. to DIN	Type of value	Material strength values in N/mm ²														
		Temperatures in °C														
		RT	100	150	200	250	300	350	400	450	500	550	600	700	800	900
2.4819 VgTÜV-W 400	R _{p0.2}	310	280		240		220									
	R _{p1}	330	305		275		215		195	200						
2.4856 DIN EN 10095	R _{p0.2}	410	350		320		300		280		170					
	R _{p1/1000000}						Manufacturer's figures						250	90	30	10
	R _{m1000000}						for Inconel 625 H						290	135	45	18
	R _{m1000}														260	107
2.4610	R _{p0.2}															
	R _{p1}	305	285		255		245		225							
2.4360	R _{p0.2}	340	315		285		270		260							
	R _{p1}															
	R _{p1/100000}															
	R _{p1/1000000}															
	R _{m10000}															
	R _{m100000}															
	K/S															
CW354H 2.0882	R _{p1}	140	130	126	123	120	117	112								
	R _{p1/100000}															
	R _{p1/1000000}															
	K/S	93	87	84	82	80	78	75								
CW024A 2.0090	R _{p1}	65	58	58												
	R _m	220	220	195	170	145										
	R _{p2/100000}															
	K/S	57	57	50	43	36										
3.3535 EN-AW 5754	R _{p0.2}	80	70													
	R _{m1000000}	(80)	45													
	K/S	67	63	56	49	41										
2.4068 Nickel	R _{p0.2}	80	70		65		60		55		50		40			
	R _{p1}	105	95		90		85		80		75		65			
	R _m	340	290		275		260		240		210		150			
	R _{p1/100000}															
3.7025 Titan	R _{p1}	200	180	150	110	90										
	R _{m10000}	220	160	150	130	110										
	R _{m1000000}	200	145	130	120	90										
Tantal	R _{p0.2}	140	100	90	80	70										
	R _m	225	200	185	175	160	150									
	A _{30[%]}	35														
	R _{p0.2}	200	160	150	140	130										
R _m		280	270	260	240	230										
	A _{30[%]}	25														

1) Room temperature values valid to 50 °C

7.2 Material datasheets

Material datasheets

Material designations according to international specifications

Material no. to DIN EN	USA			JAPAN		
	Standard	UNS designation	Semi-finished product applications / title	Standard	Designation	Semi-finished product applications
1.0254	ASTM A 53-01	K02504 A 53	Welded and seamless black-oxidized and galvanized steel tubes	JIS G 3445 (1988)	STKM 12 A	Tubes
	ASTM A 106-99	K02501 A 106	Seamless tubes of high-temperature unalloyed steel	JIS G 3454 (1988)	STPG 370	Pipes under pressure
				JIS G 3457 (1988)	STPY 400	Welded tubes
1.0255	ASTM A 135-01	K03013 A 135	Electric resistance welded tubes	JIS G 3455 (1988)	STS 370	Pipes subjected to high pressures
1.0038	ASTM A 500-01	K03000 A 500	Welded and seamless fittings of cold-formed unalloyed steel			
1.0050				JIS G 3101 (1995)	SS 490	General structural steels
1.0570	ASTM A 694-00	K03014 A 694	Forgings of unalloyed and alloyed steel for pipe	JIS G 3106 (1999)	SM 490 A	Steels for welded constructions
			flanges, fittings, valves and other parts for high-pressure drive systems	JIS G 3106 (1999)	SM 520 B	
1.0345	ASTM A 414-01	K02201 A 414	Sheet of unalloyed steel for pressure tanks	JIS G 3115 (2000)	SPV 450	Heavy plate for pressure vessels
1.0425	ASTM A 414-01	K02505 A 414		JIS G 3118 (2000)	SGV 480	
1.0481	ASTM A 414-01	K02704 A 414		JIS G 3118 (2000)	SGV 410	
1.5415	ASTM A 204-99	K12320 A 204		JIS G 3458 (1988)	STPA 12	
1.7335	ASTM A 387-99	K11789 A 387	Sheet of Cr-Mo alloyed steel for pressure tanks	JIS G 3462 (1988)	STBA 22	Boiler and heat exchanger pipes
1.7380	ASTM A 387-99	K21590 22 (22L)		JIS G 4109 (1987)	SCMV 4	Heavy plate for pressure vessels
1.0305	ASTM A 106-99	K02501 A 106	Seamless tubes of high-temperature unalloyed steel	JIS G 3461 (1988)	STB 340	Boiler and heat exchanger pipes

7.2 Material datasheets

Material datasheets

Material designations according to international specifications

Material no. to DIN EN	KOREA			CHINA		
	Standard	Designation	Semi-finished product applications	Standard	Designation	Semi-finished product applications
1.0254	KS D 3583 (1992)	SPW 400	Welded tubes of carbon steel			
1.0255						
1.0038				GBT 700 (1988)	Q 235 B; U12355	(unalloyed structural steels)
1.0050	KS D 3503 (1993)	SS 490	General structural steels	GBT 700 (1988)	Q 275; U12752	
1.0570	KS D 3517 (1995)	STKM 16C	Unalloyed steel tubes for general mechanical engineering	GBT 713 (1997)	16MnG; L20162	Plate for steam boilers
				GBT 8164 (1993)	16Mn; L20166	Strip for welded tubes
1.0345	KS D 3521 (1991)	SPPV 450	Heavy plate for pressure vessels for medium application temp.			
1.0425	KS D 3521 (1991)	SPPV 315				
1.0481						
1.5415	KS D 3572 (1990)	STHA 12	Tubes for boilers and heat exchangers	GB 5310 (1995)	15MoG; A65158	Seamless tubes for pressure vessels
1.7335	KS D 3572 (1990)	STHA 22		YB T 5132 (1993)	12CrMo; A30122	Plate of alloyed structural steels
1.7380	KS D 3543 (1991)	SCMV 4	Cr-Mo steel for pressure vessels	GB 5310 (1995)	12Cr2MoG; A30138	Seamless tubes for pressure vessels
1.0305						

7.2 Material datasheets

Material datasheets

Material designations according to international specifications

Material no. to DIN EN	USA			JAPAN		
	Standard	UNS designation (AISI)	Semi-finished product applications / title	Standard	Designation	Semi-finished product applications
1.0562	ASTM A 299-01	K02803 A 299	Plate of C-Mn-Si steel for pressure tanks	JIS G 3106 (1999)	SM 490 A;B;C;	Steels for welded constructions
	ASTM A 714-99	K12609 A 714 (II)	Welded and seamless tubes of high-strength low-alloy steel	JIS G 3444 (1994)	STK 490	Steels for welded constructions
1.0565	ASTM A 633-01	K12037 A633(D)	Normalized high-strength low-alloy structural steel			
	ASTM A 724-99	K12037 A724(C)	Plate of tempered unalloyed steel for welded pressure tanks of layered construction			
1.0566	ASTM A 573-00	K02701 A 573	Plate of unalloyed structural steel with improved toughness	JIS G 3126 (2000)	SLA 365	Heavy plate for pressure vessels (low temperature)
1.1106	ASTM A 707-02	K12510 A 707 (L3)	Forged flanges of alloyed and unalloyed steel for use in low temperatures	JIS G 3444 (1994)	STK 490	Tubes for general use

7.2 Material datasheets

Material datasheets

Material designations according to international specifications

Material no. to DIN EN	KOREA			CHINA		
	Standard	Designation	Semi-finished product applications / title	Standard	Designation	Semi-finished product applications
1.0562						
1.0565						
1.0566	KS D 3541 (1991)	SLA1 360	Heavy plate for pressure vessels (low temperature)	GBT 714 (2000)	Q420q-D; L14204	Steels for bridge construction
1.1106				GB 6654 (1996)	16MnR; L20163	Heavy plate for pressure vessels

7.2 Material datasheets

Material datasheets

Material designations according to international specifications

Material no. to DIN EN	USA			JAPAN		
	Standard	UNS designation (AISI)	Semi-finished product applications / title	Standard	Designation	Semi-finished product applications
1.4511				JIS G 4305 (1999)	SUS 430LX	Cold-rolled sheet, heavy plate and strip
1.4512	ASTM A 240-02	S40900; A 240 (409)	Sheet and strip of heatproof stainless Cr and Cr-Ni steel for pressure tanks			
1.4301	ASTM A 240-02	S30400; A 240 (304)		JIS G 4305 (1999)	SUS 304	Cold-rolled sheet, heavy plate and strip
1.4306	ASTM A 240-02	S30403; A 240 (304L)		JIS G 4305 (1999)	SUS 304L	
1.4541	ASTM A 240-02	S32100 A 240 (321)		JIS G 4305 (1999)	SUS 321	
1.4571	ASTM A 240-02	S31635 A240 (316Ti)		JIS G 4305 (1999)	SUS 316Ti	
1.4404	ASTM A 240-02	S31603 A240 (316L)		JIS G 4305 (1999)	SUS 316L	
1.4435	ASTM A 240-02	S31603 A240 (316L)		JIS G 4305 (1999)	SUS 316L	
1.4565	ASTM A 240-02	S34565 A240				
1.4539	ASTM A 240-02	N08904 A240 (904L)				
1.4529	ASTM B 625-99	N08925 B 625	Sheet and strip of low-carbon Ni-Fe-Cr-Mo-Cu alloys			

7.2 Material datasheets

Material datasheets

Material designations according to international specifications

Material no. to DIN EN	KOREA			CHINA		
	Standard	Designation	Semi-finished product applications	Standard	Designation	Semi-finished product applications
1.4511	KS D 3698 (1992)	STS 430LX	Cold-rolled sheet, heavy plate and strip			Cold-rolled sheet, heavy plate and strip
1.4512				GBT 4238 (1992)	0Cr11Ti; S11168	Hot-rolled sheet of heatproof steel, ferritic
1.4301	KS D 3698 (1992)	STS 304	Cold-rolled sheet, heavy plate and strip	GBT 3280 (1992)	0Cr18Ni9; S30408	Cold-rolled sheet, heavy plate and strip
1.4306	KS D 3698 (1992)	STS 304L		GBT 3280 (1992)	00Cr19Ni10; S30403	
1.4541	KS D 3698 (1992)	STS 321		GBT 3280 (1992)	0Cr18Ni10Ti; S32168	
1.4571	KS D 3698 (1992)	STS 316Ti		GBT 3280 (1992)	0Cr18Ni12Mo2Cu2 S31688	
1.4404	KS D 3698 (1992)	STS 316L		GBT 4239 (1991)	00Cr17Ni14Mo2; S31603	
1.4435	KS D 3698 (1992)	STS 316L		GBT 3280 (1992)	00Cr17Ni14Mo2; S31603	
1.4565						
1.4539						
1.4529	KS D 3698 (1992)	STS 317J5L	Cold-rolled sheet, heavy plate and strip			

7.2 Material datasheets

Material datasheets

Material designations according to international specifications

Material no. to DIN EN	USA			JAPAN		
	Standard	UNS Designation (AISI)	Semi-finished product applications / title	Standard	Designation	Semi-finished product applications
1.4948	ASTM A 240-02	S30409 A240 (304H)	Sheet and strip of heatproof stainless Cr and Cr-Ni steel for pressure tanks			
1.4919	ASTM A 240-02	S31609 A240 (316H)				
1.4958	ASTM A 240-02	N 08810 A 240				
1.4828	ASTM A 167-99	S30900 A 167 (309)	Sheet and strip of stainless heatproof Cr-Ni steel	JIS G 4312 (1991)	SUH 309	Heatproof sheet and heavy plate
1.4876	ASTM A 240-02	N 08800 A 240	Sheet and strip of stainless heatproof Cr and Cr-Ni steel for pressure tanks	JIS G 4902 (1991)	NCF 800	Special alloy in sheet form
2.4858	ASTM B 424-98	N 08825 B 424		JIS G 4902 (1991)	NCF 825	
2.4816	ASTM B 168-98	N 06600 B 168	Sheet and strip of low-carbon Ni-Cr-Fe and Ni-Cr-Co-Mo alloys (UNS N06600 and N06690)			
2.4819	ASTM B 575-99	N 10276 B 575	Sheet and strip of low-carbon Ni-Mo-Cr alloys			
2.4856	ASTM B 443-99	N 06625 B 443	Sheet and strip of Ni-Cr-Mo-Nb alloy (UNS N06625)	JIS G 4902 (1991)	NCF 625	Special alloy in sheet form
2.4610	ASTM B 575-99	N 06455 B 575	Sheet and strip of low-carbon Ni-Mo-Cr alloys			
2.4360	ASTM B 127-98	N 04400 B 127	Sheet and strip of Ni-Cu alloy (UNS N04400)			

7.2 Material datasheets

Material datasheets

Material designations according to international specifications

Material no. to DIN EN	KOREA			CHINA		
	Standard	Designation	Semi-finished product applications	Standard	Designation	Semi-finished product applications
1.4948						
1.4919						
1.4958						
1.4828	KS D 3732 (1993)	STR 309	Heatproof sheet and heavy plate	GBT 1221 (1992)	1Cr20Ni14Si2; S38210	Heatproof steels, austenitic
1.4876	KS D 3532 (1992)	NCF 800	Special alloys in sheet and heavy plate form	GBT 15007 (1994)	NS 111; H01110	Stainless alloys
2.4858	KS D 3532 (1992)	NCF 825		GBT 15007 (1994)	NS 142; H01420	
2.4816				GBT 15007 (1994)	NS 312; H03120	
2.4819				GBT 15007 (1994)	NS 333; H03330	
2.4856	KS D 3532 (1992)	NCF 625	Special alloys in sheet and heavy plate form	GBT 15007 (1994)	NS 336; H03360	
2.4610				GBT 15007 (1994)	NS 335; H03350	
2.4360						

7.3 Nominal pressure levels for malleable iron

Threaded fasteners of malleable cast iron are applicable up to the operating pressures indicated in the table below, depending on type of fluid and operating temperature.

permissible operating pressure for the fluids					
DN	d	water and gas	gases and steam	gases and steam	oils
	Inch	up to max. 120 °C	up to max. 150 °C	up to 250 °C	up to 200 °C
nipples, flat sealing threaded fasteners					
6-50	¼ - 2	65 bar	50 bar	40 bar	35 bar
conically sealing threaded fasteners					
6-32	¼ - 1 ¼	65 bar	50 bar	40 bar	35 bar
40	1 ½	65 bar	50 bar	40 bar	30 bar
50	2	55 bar	40 bar	32 bar	24 bar

Sealing is to be carried out with special care. The sealing materials are to be selected according to the operating conditions. Only approved sealing materials must be applied for sealing of threaded fasteners in drinking water and gas pipe systems.

Only high-quality threads are appropriate for high operating requirements.

7.4 Corrosion resistance

General

Flexible metal elements are basically suitable for the transport of critical fluids if a sufficient resistance is ensured against all corrosive media that may occur during the entire lifetime.

The flexibility of the corrugated elements like bellows or corrugated hoses generally require their wall thickness to be considerably smaller than that of all other parts of the system in which they are installed.

As therefore increasing the wall thickness to prevent damages caused by corrosion is not reasonable, it becomes essential to select a suitable material for the flexible elements which is sufficiently resistant.

Special attention must be paid to all possible kinds of corrosion, especially pitting corrosion, intercrystalline corrosion, crevice corrosion, and stress corrosion cracking, (see Types of corrosion).

This leads to the fact that in many cases at least the ply of the flexible element that is exposed to the corrosive fluid has to be chosen of a material with even higher corrosion resistance than those of the system parts it is connected to (see Resistance table).

Types of corrosion

According to EN ISO 8044, corrosion is the “physicochemical interaction between a metal and its environment that results in changes in the properties of the metal, and which may lead to significant impairment of the function of the metal, the environment, or the technical system, of which these form a part. This interaction is often of an electrochemical nature”.

Different types of corrosion may occur, depending on the material and on the corrosion conditions. The most important corrosion types of ferrous and non-ferrous metals are described below.

Uniform corrosion

A general corrosion proceeding at almost the same rate over the whole surface. The loss in weight which occurs is generally specified either in g/m²h or as the reduction in the wall thickness in mm/year.

This type of corrosion includes the rust which commonly is found on unalloyed steel (e. g. caused by oxidation in the presence of water).

Stainless steels can only be affected by uniform corrosion under extremely unfavourable conditions, e.g. caused by liquids, such as acids, bases and salt solutions.

Pitting corrosion

A locally limited corrosion attack that may occur under certain conditions, called pitting corrosion on account of its appearance. It is caused by the effects of chlorine, bromine and iodine ions, especially when they are present in hydrous solutions.

This selective type of corrosion cannot be calculated, unlike surface corrosion, and can therefore only be kept under control by choosing an adequate resistant material. The resistance of stainless steels to pitting corrosion increases in line with the molybdenum content in the chemical composition of the material. The resistance of materials to pitting corrosion can approximately be compared by the so-called pitting resistance equivalent ($PRE = Cr \% + 3.3 \cdot Mo \% + 30 N \%$), whereas the higher values indicate a better resistance.

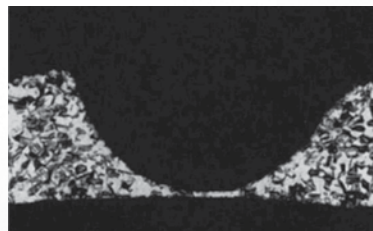

Fig. 7.1 Pitting corrosion on a cold strip made of austenitic steel. Plan view (50-fold enlargement)

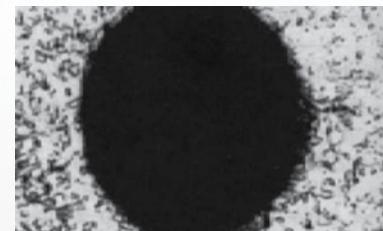

Fig. 7.2 Sectional view (50-fold enlargement)

Intergranular corrosion

Intergranular corrosion is a local, selective type of corrosion which primarily affects the grain boundaries. It is caused by deposits in the material structure, which lead to a reduction in the corrosion resistance in the regions close to the grain boundaries. In stainless steels this type of corrosion can advance up to the point where the grain composition is dissolved (grain disintegration: Fig.7.3)

These deposit processes are dependent on temperature and time in CrNi alloys, whereby the critical temperature range is between 550 and 650 °C and the period up to the onset of the deposit processes differs according to the type of steel.

7.4 Corrosion resistance

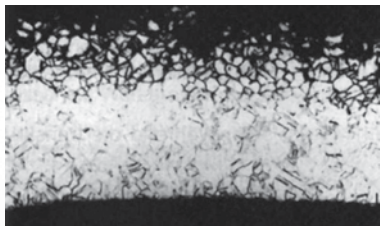

Fig. 7.3 Intergranular corrosion (decay) in austenitic material 1.4828. Sectional view (100-fold enlargement)

This must be taken into account, for example, when welding thick-walled parts with a high thermal capacity. These deposit-related changes in the structure can be reversed by means of solution annealing (1000 – 1050 °C).

This type of corrosion can be avoided by using stainless steels with low carbon content ($\leq 0,03$ % C) or containing elements, such as titanium or niobium. For flexible elements, this may be stabilized material qualities like 1.4541, 1.4571 or low-carbon qualities like 1.4404, 1.4306.

The resistance of materials to intergranular corrosion can be verified by a standardized test (Monypenny - Strauss test according to ISO 3651-2). Certificates to be delivered by the material supplier, proving resistant to IGC according to this test are therefore asked for in order and acceptance test specifications.

Stress corrosion cracking

This type of corrosion is observed most frequently in austenitic materials, subjected to tensile stresses and exposed to a corrosive agent. The most important agents are alkaline solutions and those containing chloride.

The form of the cracks may be either transgranular or intergranular. Whereas the transgranular form only occurs at temperatures higher than 50 °C (especially in solutions containing chloride), the intergranular form can be observed already at room temperature in austenitic materials in a neutral solutions containing chloride.

At temperatures above 100 °C SCC can already be caused by very small concentrations of chloride or lye – the latter always leads to the transgranular form.

7.4 Corrosion resistance



Fig. 7.4 Transgranular stress corrosion cracking on a cold strip made of austenitic steel. Sectional view (50-fold enlargement)

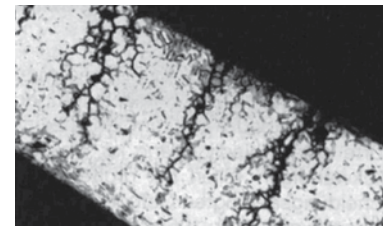

Fig. 7.5 Intergranular stress corrosion cracking on a cold strip made of austenitic steel. Sectional view (50-fold enlargement)

Stress corrosion cracking takes the same forms in non-ferrous metals as in austenitic materials. Damage caused by intergranular stress corrosion cracking can occur in nickel and nickel alloys in highly concentrated alkalis at temperatures above 400 °C, and in solutions or water vapour containing hydrogen sulphide at temperatures above 250 °C. A careful choice of materials based on a detailed knowledge of the existing operating conditions is necessary to prevent from this type of corrosion damage.

Crevice corrosion

Crevice corrosion is a localized, seldom encountered form of corrosion found in crevices which are the result of the design or of deposits. This corrosion type is caused by the lack of oxygen in the crevices, oxygen being essential in passive materials to preserve the passive layer.



Fig. 7.6 Crevice corrosion on a cold strip made from austenitic steel. Sectional view (50-fold enlargement)

7.4 Corrosion resistance

Because of the risk of crevice corrosion design and applications should be avoided which represent crevice or encourage deposits.

The resistance of high-alloy steels and Ni-based alloys to this type of corrosion increases in line with the molybdenum content of the materials. Again pitting resistance equivalent (PRE) (see Pitting corrosion) can be taken as criteria for assessing the resistance to crevice corrosion.

Dezincing

A type of corrosion which occurs primarily in copper-zinc alloys with more than 20% zinc. During the corrosion process the copper is separated from the brass, usually in the form of a spongy mass. The zinc either remains in solution or is separated in the form of basic salts above the point of corrosion. The dezincing can be either of the surface type or locally restricted, and can also be found deeper inside.

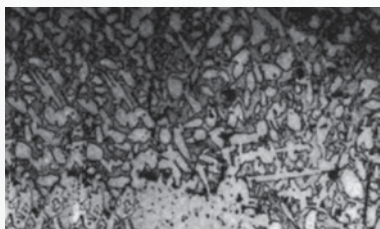

Fig. 7.7 Dezincing on a Copper-Zinc alloy (Brass / CuZn37). Sectional view (100-fold enlargement)

Conditions which encourage this type of corrosion include thick coatings from corrosion products, lime deposits from the water or other deposits of foreign bodies on the metal surface. Water with high chloride content at elevated temperature in conjunction with low flow velocities further the occurrence of dezincing.

Contact corrosion

A corrosion type which may result from a combination of different materials. Galvanic potential series are used to assess the risk of contact corrosion, e.g. in seawater. Metals which are close together on the potential series are mutually compatible; the anodic metal corrodes increasingly in line with the distance between two metals.

7.4 Corrosion resistance

Materials which can be encountered in both the active and passive state must also be taken into account. A CrNi alloy, for example, can be activated by mechanical damage to the surface, by deposits (diffusion of oxygen made more difficult) or by corrosion products on the surface of the material. This may result in a potential difference between the active and passive surfaces of the metal, and in material erosion (corrosion) if an electrolyte is present.

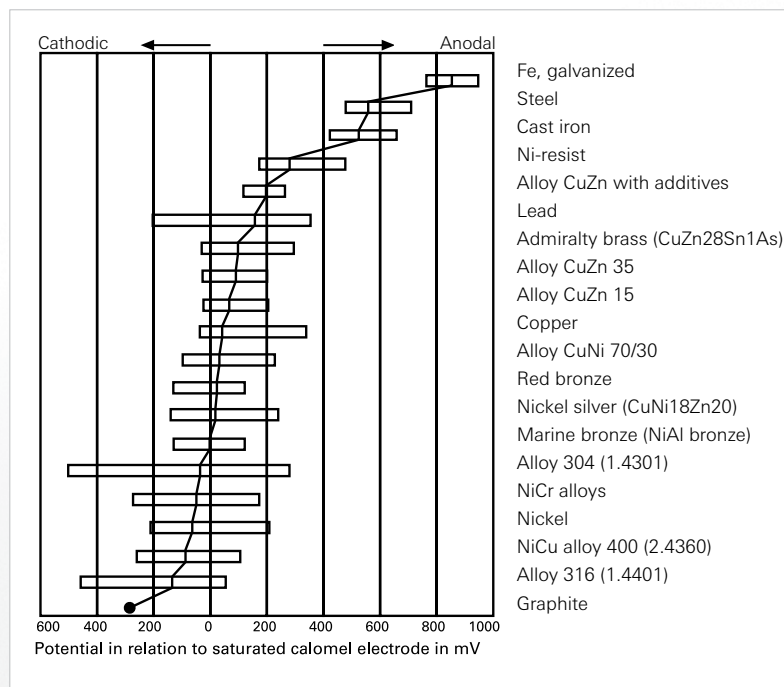

Fig. 7.8 Galvanic potentials in seawater
Source: DECHEMA material tables

7.4 Corrosion resistance

Resistance table

The table below provides a summary of the resistance to different media for metal materials most commonly used for flexible elements. The table has been drawn up on the basis of relevant sources in accordance with the state of the art; it makes no claims to completeness.

The main function of the table is to provide the user with an indication of which materials are suitable or of restricted suitability for the projected application, and which can be rejected right from the start.

The data constitutes recommendations only, for which no liability can be accepted. The exact composition of the working medium, varying operating states and other boundary operating conditions must be taken into consideration when choosing the material.

7.4 Corrosion resistance

Table key

Assessment	Corrosion behaviour	Suitability
0	resistant	suitable
1	uniform corrosion with reduction in thickness of up to 1 mm/year	restricted suitability
P	risk of pitting corrosion	
S	risk of stress corrosion cracking	
2	hardly resistant, uniform corrosion with reduction in thickness of more than 1 mm/year up to 10 mm/year	not recommended
3	not resistant (different forms of corrosion)	unsuitable

Meanings of abbreviations

adp:	acid dew point
bp:	boiling point
cs:	cold-saturated (at room temperature)
dr:	dry condition
hy:	hydrous solution
me:	melted
mo:	moist condition
sa:	saturated (at boiling point)

7.4 Corrosion resistance

Resistance table

Medium		Materials																			
Designation Chemical formula	Concentration	Temperature	Stainless steels			Nickel alloys				Copper alloys			Pure metals								
			Non-/low- alloy steels	Ferritic steels	Austenitic steels	Austenitic + Mo	steels 2.4888 / alloy	8252.4816 / alloy 600	2.4856 / alloy 625	2.4610, 2.4819 / alloy C-4, C-2.46	2.4360 / alloy 400	2.0882 / alloy CuNi 70/30	Tombac	Bronze	Copper	Nickel	Titanium	Tantalum	Aluminium	Silver	
	%	°C																			
Acetanilide (Antifebrine) C ₈ H ₉ NO		<114	0	0	0	0	0	0	0	0	0	0	0	0	0	0	0	0	0	0	0
Acetic acid CH ₃ COOH or C ₂ H ₄ O ₂	5 50 50 80 96 98	20 bp 20 20 20 20	3 3 3 3 3 3	0 3 3 3 3 3	0 0 0 0 0 0	0 0 0 0 0 0	0 0 0 0 0 0	1 1 0 0 0 0	0 0 0 0 0 0	1 0 0 0 0 0	0 0 0 0 0 0	0 0 0 0 0 0	0 0 0 0 0 0	0 0 0 0 0 0	0 0 0 0 0 0	0 0 0 0 0 0	0 0 0 0 0 0	0 0 0 0 0 0	0 0 0 0 0 0	0 0 0 0 0 0	0 0 0 0 0 0
Acetic acid vapour -	33 100 100	20 >50 <bp	3 3 3	1 3 3	1 3 3	0 0 0	0 1 3	0 0 0	0 1 3	0 0 0	0 0 0	0 0 0	0 0 0	0 0 0	0 0 0	0 0 0	0 0 0	0 0 0	0 0 0	0 0 0	0 0 0
Acetic aldehyde CH ₃ -CHO	100	bp	1	1	0	0	0	0	0	0	0	0	0	0	0	0	0	0	0	0	0
Acetic anhydride (CH ₃ -CO) ₂ O	all 100 100	20 60 bp	1 3 3	0 0 0	0 0 0	0 0 0	0 1 3	0 0 0	0 0 0	1 1 0	1 3 0	0 0 0	0 0 0	0 0 0	0 0 0	0 0 0	0 0 0	0 0 0	0 0 0	0 0 0	0 0 0
Acetic anilide (Antifebrine)		<114	0	0	0	0	0	0	0	0	0	0	0	0	0	0	0	0	0	0	0
Acetone CH ₃ COCH ₃	100	bp	1	0	0	0	0	0	0	0	0	0	0	0	0	0	0	0	0	0	0
Acetyl chloride CH ₃ COCl		20	1	1	1	1	1	1	0	1	1	1	1	1	0	1	0	1	0		
Acetylene H-C≡C-H	dr dr	20 200	0 1	0 0	0 0	0 0	0 0	0 0	0 0	0 0	0 0	3 3	3 3	3 3	3 3	0 0	0 0	0 0	0 0	0 0	0 0
Acetylene dichloride C ₂ H ₂ Cl ₂	hy dr	5 100	20 20	0 0	P P	P P	0 0	0 0	0 0	0 0	0 0	0 0	0 0	0 0	0 0	0 0	0 0	0 0	0 0	0 0	0 0
Acetylen tetrachloride CHCl ₂ -CHCl ₂	100 100	20 bp	0 0	0 0	0 0	0 0	0 0	0 0	0 0	0 0	0 0	0 0	0 0	0 0	0 0	0 0	0 0	0 0	0 0	0 0	0 0
Adipic acid HOOC(CH ₂) ₄ COOH	all	200	0	0	0	0	0	0	0	0	0	0	0	0	0	0	0	0	0	0	0
Alcohol see ethyl or methyl alcohol																					

7.4 Corrosion resistance

Resistance table

Medium		Materials																			
Designation Chemical formula	Concentration	Temperature	Stainless steels			Nickel alloys				Copper alloys			Pure metals								
			Non-/low- alloy steels	Ferritic steels	Austenitic steels	Austenitic + Mo	steels 2.4888 / alloy	8252.4816 / alloy 600	2.4856 / alloy 625	2.4610, 2.4819 / alloy C-4, C-2.46	2.4360 / alloy 400	2.0882 / alloy CuNi 70/30	Tombac	Bronze	Copper	Nickel	Titanium	Tantalum	Aluminium	Silver	
	%	°C																			
Allyl alcohol CH ₂ CHCH ₂ OH	100	bp		0	0	0	0	0	0	0	0	0	0	0	0	0	0	0	0	0	0
Allyl chloride CH ₂ =CHCH ₂ Cl	100	25				0	0	0	0	0	0	0	0	0	0	0	0	0	0	0	0
Alum KAl(SO ₄) ₂	hy hy	100 20 10 10	20 20 80	1 0 1	1 0 1	0 0 0	0 0 0	0 0 0	0 0 0	0 0 0	0 0 0	0 0 0	0 0 0	0 0 0	0 0 0	0 0 0	0 0 0	0 0 0	0 0 0	0 0 0	0 0 0
Aluminium Al	me	750	3	3	3	3				3								3	3		
Aluminium acetate (CH ₃ -COO) ₂ Al(OH)	hy sa	3 20	3 3	0 0	0 0	0 0			0 1									0 0	0 0	0 1	
Aluminium chloride AlCl ₃	hy	5	20	3	3	3	P	1	1	0	0	1	3	3	1	3	1	0	0	0	3
Aluminium fluoride AlF ₃	hy	10	25	3	3	3	3			1	1							1	1	0	3
Aluminium formate Al(HCOO) ₃				1	0	0	0	0	0	0	0	0	0	0	0	0	0	0	1	0	0
Aluminium hydroxide Al(OH) ₃	hy	10	20	1	3	0	0	0	0	0	0	0	0	1	0			0	0	0	1
Aluminium nitrate Al(NO ₃) ₃				0	0	0	0	0	0	0	0	0	0	0	0	0	0	0	0	0	1
Aluminium oxide Al ₂ O ₃			20	1	1	0	0	0	0	0	0	3	0	0	0	0	0	0	0	0	3
Aluminium potassium sulphate see alum																					
Aluminium sulphate Al ₂ (SO ₄) ₃	hy hy	10 15	<bp 50	3 3	3 3	3 3	0 1	0 0	1 1	0 1	1 1	3 1	3 1	3 1	3 1	3 1	1 0	0 0	0 0	0 0	3 3
Ammonia NH ₃	dr hy hy sa	10 20 20 40	20 20 40 0	0 0 0 0	0 0 0 0	0 0 0 0	0 0 0 0	0 0 0 0	0 0 0 0	0 0 0 0	0 0 0 0	0 0 0 0	0 0 0 0	0 0 0 0	0 0 0 0	0 0 0 0	0 0 0 0	0 0 0 0	0 0 0 0	0 0 0 0	0 0 0 0

7.4 Corrosion resistance

Resistance table

Medium				Materials															
Designation Chemical formula	Concentration %	Temperature C	Non-/low- alloy steels	Stainless steels			Nickel alloys				Copper alloys			Pure metals					
				Ferritic steels	Austenitic steels	Austenitic + Mo	steels 2.4888 / alloy 8252.4816 / alloy 600	2.4856 / alloy 625	2.4610.2.4819 / alloy C-4, C-246	2.4360 / alloy 400	2.0882 / alloy CuNi 70/30	Tombac	Bronze	Copper	Nickel	Titanium	Tantalum	Aluminium	Silver
				P	P	P	0	0	1	0	0	0	0	0	0	0	0	0	0
Ammonia bromide NH ₄ Br	hy	10	25	3	P	P	P	0	0	1	0	0	0	0	0	0	0	0	0
Ammonium acetate CH ₃ -COONH ₄				1	0	0	0										0	0	
Ammonium alum NH ₄ Al(SO ₄) ₂	hy	cs	20		0	0	0									3	0		
Ammonium bicarbonate (NH ₄)HCO ₃	hy			0	0	0	0	1	3		3	3			3		0	0	
Ammonium bifluoride NH ₄ HF ₂	hy hy	10 100	25 20	3 3	3 3	3 0	3 0			0	0					3	0		
Ammonium bromide see ammonia bromide																			
Ammonium carbonate NH ₄ CO ₃	hy hy	1 50	20 bp	0 0	0 0	0 0	0 0	0 0	0 0	1 0	0 1	0 1		1 1		0 0	0 0	0 0	
Ammonium chloride NH ₄ Cl	hy hy hy	1 10 50	20 100 bp	1 P P	P P P	P P P	0 0 0	0 0 0	0 0 1	0 0 1	0 1 1	0 1 1	S S S	1 1 1	1 0 1	0 0 1	1 1 1	1 1 1	
Ammonium fluoride NH ₄ F	hy hy	10 hg 70 80	25 3 3	1 0 3	1 0 3	0 0 3	0 0 3	0 0 0	0 0 0	0 0 0	0 0 0			3 3 3			0		
Ammonium fluosilicate (NH ₄) ₂ SiF ₆	hy	20	40	3	1	0	0	0	0	0	0	0			0				
Ammonium formate HCOONH ₄	hy hy	10 10	20 70	1	0	0	0	0	0	0	0	0			0	0	0	0	
Ammonium hydroxide NH ₄ OH		100	20		0	0	0	0	0	0	0	0	3	3	3	0	0	0	1
Ammonium nitrate NH ₄ NO ₃	hy hy	5 100	20 bp	3 3	0 0	0 0	0 0	0 0	1 0	0 0	3 3	3 3	3 3			0	0	0	
Ammonium oxalate (COONH ₄) ₂	hy hy	10 10	20 bp	1 3	1 3	0 1	0 0	0 1	0 0	0 1	0 1	0 1		1 1		0 1	0 0		
Ammonium perchlorate NH ₄ ClO ₄	hy	10	20		P	P	P		1						0				

7.4 Corrosion resistance

Resistance table

Medium				Materials															
Designation Chemical formula	Concentration %	Temperature C	Non-/low- alloy steels	Stainless steels			Nickel alloys				Copper alloys			Pure metals					
				Ferritic steels	Austenitic steels	Austenitic + Mo	steels 2.4888 / alloy 8252.4816 / alloy 600	2.4856 / alloy 625	2.4610.2.4819 / alloy C-4, C-246	2.4360 / alloy 400	2.0882 / alloy CuNi 70/30	Tombac	Bronze	Copper	Nickel	Titanium	Tantalum	Aluminium	Silver
				P	P	P	0	0	1	0	0	0	0	0	0	0	0	0	0
Ammonium persulphate (NH ₄) ₂ S ₂ O ₈	hy hy	5 10	20 25	3	0	0	0	0	1	0	0	0	0	1	0	0	0	0	3
Ammonium phosphate NH ₄ H ₂ PO ₄	hy	5	25	0	1	1	0	0	1	0	0	1	1	1	3	1	0	0	1
Ammonium rhodanide NH ₄ CNS			70		0	0	0											0	0
Ammonium sulphate (NH ₄) ₂ SO ₄	hy hy hy	1 10 20	20 20 bp	0 0 1	0 1 1	0 0 0	0 0 0	0 0 0	1 0 3	0 0 3	0 1 2	1 1 3	3 3 3	3 3 1	3 3 1	1 0 0	0 3 0	0 0 0	P P 1
Ammonium sulphite (NH ₄) ₂ SO ₃	cs sa	20 bp	20 bp	1 3	0 1	0 1	0 3	3 3				3 3	3 3		3 3	3 3	0 0	0 0	
Ammonium sulphocyanate see ammonium rhodanide																			
Amyl acetate CH ₃ -COOC ₅ H ₁₁		all 100	20 bp	1		1	1	1	1	0	1	1	1	1	1	0	0	1	1
Amyl alcohol C ₅ H ₁₁ OH		100 100	20 bp	0 1	0 0	0 0	0 0	0 0	0 0	0 0	0 0	0 0	0 0	0 0	0 0	0 0	0 0	0 0	1
Amyl chloride CH ₃ (CH ₂) ₃ CH ₂ Cl		100	bp	1	P	P	0	1	0	0	1	0			0	1	0	0	3
Amyl thiol		100	160																
Aniline C ₆ H ₅ NH ₂		100 100	20 180		0 1	0 1	0 1	0 0	1 0	0 0	0 3	1	3	3	3	3	0	0	0
Aniline chloride C ₆ H ₅ NH ₂ HCl	hy hy	5 5	20 100		P P	P P							0 3		3 3	3 0	0 0	0 3	
Aniline hydrochloride see anilin chloride																			
Aniline sulphate			20			0					0								1
Aniline sulphite	hy hy	10 cs	20 20		0 0	0 0			1		0								
Antifreeze Glysantine			20		0	0	0	0	0	0	0	0	0			0	0	0	0

7.4 Corrosion resistance

Resistance table

Medium			Materials																	
Designation Chemical formula	Concentration	Temperature	Non-/low- alloy steels																	
			Stainless steels			Nickel alloys				Copper alloys			Pure metals							
	%	°C	Ferritic steels	Austenitic steels	Austenitic + Mo	steels 2.4858 / alloy 8252.4816 / alloy 600	2.4856 / alloy 625	2.4610.2.4819 / alloy C-4, C-2.46	2.4360 / alloy 400	2.0882 / alloy CuNi 70/30	Tombac	Bronze	Copper	Nickel	Titanium	Tantalum	Aluminium	Silver		
Bromoform CHBr ₃	dr mo	20	0 3	0 0	0 0	0 0	0 0	0 0	0 0	0 0	0 0	0 0	0 0	0 0	0 0	0 0	0 0	0 0	0 0	
1,3-Butadiene CH ₂ =CHCH=CH ₂																				
Butane C ₄ H ₁₀	100 120	20	0 1	0 0	0 0	0 0	0 0	0 0	0 0	0 0	0 0	0 0	0 0	0 0	0 0	0 0	0 0	0 0	0 0	0 0
Butanol CH ₃ -CH ₂ -CH ₂ -CH ₂ -OH	100 100	20 bp	0 0	0 0	0 0	0 0	0 0	0 0	0 0	0 0	0 0	0 0	0 0	0 0	0 0	0 0	0 0	0 0	0 0	0 0
Butter		20	3	0	0	0	0	0	0	0	0	0	0	0	0	0	0	0	0	0
Buttermilk		20	3	0	0	0	0	0	0	0	0	0	0	0	0	0	0	0	0	0
Butylacetate CH ₃ COOC ₄ H ₉		20 bp	1 1	0 0	0 0	0 0	0 0	0 0	0 0	1 0	0 0	0 0	0 0	0 0	0 0	0 0	0 0	0 0	0 0	0 0
Butyric acid CH ₃ -CH ₂ -CH ₂ -COOH	hy hy	cs sa	20 bp	3 3	0 3	0 3	0 1	0 3	0 0	0 1	0 0	0 0	0 0	0 0	0 0	0 0	0 0	0 0	0 0	0 0
Cadmium Cd	me				3	3														
Calcium Ca	me	850	3		3	3														
Calcium bisulphite CaSO ₃	cs sa	20 bp	3 3	3 3	0 3	0 3	0 0			1	3	1	0		0					
Calcium carbonate CaCO ₃		20	1	0	0	0	0	0	0	0	0	0	0	0	0	0	0	0	0	0
Calcium chlorate Ca(ClO ₃) ₂	hy hy	10 10	20 100	P 3	P 3	P P	1 1	1 1	1 1	1 1	1 1	3 3		1 1	1 1	0 0				
Calcium chloride CaCl ₂	hy hy	5 10	100 20	3 3	P P	P P	0 0	0 0	0 0	0 0	0 0	0 0	0 0	0 0	0 0	0 0	0 0	0 0	0 0	0 0
Calcium hydroxide Ca(OH) ₂				0	0	0	0	1	1	0	0	1	0	0	0	0	0	0	0	3

7.4 Corrosion resistance

Resistance table

Medium			Materials																	
Designation Chemical formula	Concentration	Temperature	Non-/low- alloy steels																	
			Stainless steels			Nickel alloys				Copper alloys			Pure metals							
	%	°C	Ferritic steels	Austenitic steels	Austenitic + Mo	steels 2.4858 / alloy 8252.4816 / alloy 600	2.4856 / alloy 625	2.4610.2.4819 / alloy C-4, C-2.46	2.4360 / alloy 400	2.0882 / alloy CuNi 70/30	Tombac	Bronze	Copper	Nickel	Titanium	Tantalum	Aluminium	Silver		
Calcium hypochlorite Ca(OCl) ₂	hy hy	2 cs	20	3 3	3 3	P P	0 0	3 0	0 0	0 0	0 0	0 0	0 0	0 0	0 0	0 0	0 0	0 0	0 0	0 0
Calcium nitrate Ca(NO ₃) ₂			20	3	0	0	0	0	0	0	0	0	0	0	0	0	0	0	0	0
Calcium oxalate (COO) ₂ Ca	mo		20	1	0	0	0	0	0	0	0	0	0	0	0	0	0	0	0	3
Calcium oxide CaO			20	0	0	0	0	0	0	0	0	0	0	0	0	0	0	0	0	3
Calcium sulphate CaSO ₄	mo mo		20 bp	1 1	0 0	0 0	0 0	0 0	0 0	0 0	0 0	0 0	0 0	0 0	0 0	0 0	0 0	0 0	0 0	1 1
Calcium sulphite CaSO ₃	hy hy	cs sa		0	0	0	0	0	0	0	0	0	0	0	0	0	0	0	0	1
Carbolic acid C ₆ H ₅ (OH)	hy		20 bp bp	0 3 3	0 3 3	0 3 0	0 0 0	1 1 0	0 1 0	0 0 0	0 0 0	0 0 0	0 0 0	0 0 0	0 0 0	0 0 0	0 0 0	0 0 0	0 0 0	0 0 0
Carbon dioxide CO ₂	dr dr mo mo	100 100 20 100	<540 1000 25 25	0 3 1	0 0 0	0 0 0	0 0 0	0 0 0	0 0 0	0 0 0	0 0 0	0 0 0	0 0 0	0 0 0	0 0 0	0 0 0	0 0 0	0 0 0	0 0 0	0 0 0
Carbon monoxide CO		100 100	20 <540	0 3	0 0	0 0	0 0	0 0	0 0	0 0	0 0	0 0	0 0	0 0	0 0	0 0	0 0	0 0	0 0	0 0
Carbon tetrachloride CCl ₄	dr dr mo mo		20 bp 25 bp	0 1 1 3	0 0 1	0 0 1	0 0 0	0 0 0	0 0 0	0 0 0	0 0 0	0 0 0	0 0 0	0 0 0	0 0 0	0 0 0	0 0 0	0 0 0	0 0 0	0 0 0
Carbonic acid see carbon dioxide																				
Caustic-soda solution see sodium hydroxide																				
Chilean nitrate see sodium nitrate																				
Chloral CCl ₃ -CHO		20																		0

7.4 Corrosion resistance

Resistance table

Medium		Materials																		
Designation Chemical formula	Concentration %	Temperature C	Non-/low- alloy steels		Stainless steels		Nickel alloys				Copper alloys		Pure metals							
			Ferritic steels	Austenitic steels	Austenitic + Mo	steels 2.4858 / alloy		2.4856 / alloy 625	2.4610, 2.4819 / alloy C-4, C-2.46	2.4360 / alloy 400	2.0882 / alloy CuNi 70/30	Tombac	Bronze	Copper	Nickel	Titanium	Tantalum	Aluminium	Silver	
						8252.4816 / alloy 600	8252.4816 / alloy 600													
Dibromethane CH ₂ Br-CH ₂ Br			1	0	0															
Dichlorofluoromethane CF ₂ Cl ₂	dr dr mo	bp 20 20		0	0	0	0	0	0	0	0	0	0	0	0	0	0	0	0	0
Dichloroethane CH ₂ Cl-CH ₂ Cl	dr mo	100 20	0	P	P	P	1	0			0	1		1		0	0	0	0	1
Dichloroethylene see acetylene dichloride																				
Diethyl ether (C ₂ H ₅) ₂ O			0	0	0	0	0	0	1	0	0	0	0	0	0	0	0	0	0	0
Ethane CH ₃ -CH ₃		20	0	0	0	0	0	0	0	0	0	0	0	0	0	0	0	0	0	0
Ether see diethyl ether																				
Ethereal oils		20	1	0	0	0	0	0	0	0	0	0	0	0	0	0	0	0	0	0
Ethyl alcohol C ₂ H ₅ OH	all all	20 bp	0	0	0	0	0	0	0	0	0	0	0	0	0	0	0	0	0	0
Ethylbenzene C ₆ H ₅ -C ₂ H ₅			1	0	0	0	0	0	0	0	0	0	0	0	0	0	0	0	0	0
Ethyl chloride C ₂ H ₅ Cl			0	S	S	S	0	0	1	0	0	1	1	1	0	0	1	0		
Ethylene CH ₂ =CH ₂		20	0	0	0	0														0
Ethylene dibromide see dibromomethane																				
Ethylene dichloride see dichloroethane																				
Ethylene glycol CH ₂ OH-CH ₂ OH	100	20	0	0	0	0	0	1	0	0	1	0	0	0	0	1	0	0	0	0
Exhaust gases see combustion gas																				

7.4 Corrosion resistance

Resistance table

Medium		Materials																		
Designation Chemical formula	Concentration %	Temperature C	Non-/low- alloy steels		Stainless steels		Nickel alloys				Copper alloys		Pure metals							
			Ferritic steels	Austenitic steels	Austenitic + Mo	steels 2.4858 / alloy		2.4856 / alloy 625	2.4610, 2.4819 / alloy C-4, C-2.46	2.4360 / alloy 400	2.0882 / alloy CuNi 70/30	Tombac	Bronze	Copper	Nickel	Titanium	Tantalum	Aluminium	Silver	
						8252.4816 / alloy 600	8252.4816 / alloy 600													
Fats			0	0	0	0	0	0	0	0	0	0	0	0	0	0	0	0	0	0
Fatty acid C ₁₇ H ₃₃ COOH	100 100 100 100 100	20 60 150 180 300	0	0	0	0	0	0	0	0	0	0	0	0	0	0	0	0	0	0
Fixing salt see sodium thiosulphate																				
Flue gases see combustion gases																				
Fluorine F	mo dr dr dr	20 20 200 500	3	3	3	3														
Fluorosilicic acid H ₂ (SiF ₆) vapour	100 25 70	20 20 20	3	3	P	P	1	1	1	1	3	1	3	1	1	1	3			3
Formaldehyde CH ₂ O	hy hy hy	10 40 80 85	20	3	0	0	0	0	0	0	0	0	0	0	0	0	0	0	0	0
Formic acid HCOOH	10 20 80 85	20 bp bp 65	3	3	1	0	0	1	0	0	1	0	0	0	0	0	0	0	0	0
Fuels Benzene Benzene Benzene-alcohol-mixture Diesel oil		20 bp 20 20	0	0	0	0	0	0	0	0	0	0	0	0	0	0	0	0	0	0
Furfural	100 100	25 bp	1	1	1	1					0	0	3	0	0	3			0	
Galic acid C ₆ H ₄ (OH) ₃ COOH	hy	1 100	20 bp	1	0	0	0				0								0	

7.4 Corrosion resistance

Resistance table

Medium		Materials																				
Designation Chemical formula	Concentration %	Temperature C	Non-/low- alloy steels			Stainless steels			Nickel alloys				Copper alloys		Pure metals							
			Ferritic steels	Austenitic steels	Austenitic + Mo	Ferritic steels	Austenitic steels	Austenitic + Mo	steels 2.4858 / alloy 8252.4816 / alloy 600	2.4856 / alloy 625	2.4610, 2.4819 / alloy C-4, C-246	2.4360 / alloy 400	2.0882 / alloy CuNi 70/30	Tombac	Bronze	Copper	Nickel	Titanium	Tantalum	Aluminium	Silver	
	Gelatine		20 80	0 1	0 0	0 0	0 0	0 0	0 0	0 0	0 0	0 0	0 0	0 0	0 0	0 0	0 0	0 0	0 0	0 0	0 0	0 0
Glacial acetic acid CH ₃ CO ₂ H see acetic acid																						
Glass me		1200	1		1	1																
Glauber salt see sodium sulphate																						
Gluconic acid CH ₂ OH(CHOH) ₄ -COOH	100	20	1	0	0	0	0	0	0	0	0	0	0	0	0	0	0	0	0	0	0	0
Glucose C ₆ H ₁₂ O ₆ hy		20		0	0	0								0	1	0	0	0	0	0	0	0
Glutamic acid HOOC-CH ₂ -CH ₂ - CHNH ₂ -COOH		20 80	1 3	P P	P P	0 0	0 0	1 1	0 0	0 1						1						
Glycerine CH ₂ OH-CHOH-CH ₂ OH	100 100	20 bp	0 1	0 1	0 0	0 0	0 0	0 0	0 0	0 0	0 0	0 0	0 0	0 0	0 0	0 0	0 0	0 0	0 0	0 0	0 0	1
Glycol see ethylenglycol																						
Glycolic acid CH ₂ OH-COOH		20 bp	3 3	1 3	1 3	1 3			0 0							0 0				1 1		
Glysantine see antifreeze																						
Hexachloroethane CCl ₃ -CCl ₃		20		0	0	0	0	0	0	0	0	0				0				3		
Hexamethylene-tetramine (CH ₂) ₆ N ₄ hy hy	20 80	60 60	1 3	0 0	0 0				0 0												1	
Household ammonia see ammonium hydroxide																						
Hydrazene H ₂ N-NH ₂		20	0	0		3	3		3							3				1		

7.4 Corrosion resistance

Resistance table

Medium		Materials																				
Designation Chemical formula	Concentration %	Temperature C	Non-/low- alloy steels			Stainless steels			Nickel alloys				Copper alloys		Pure metals							
			Ferritic steels	Austenitic steels	Austenitic + Mo	Ferritic steels	Austenitic steels	Austenitic + Mo	steels 2.4858 / alloy 8252.4816 / alloy 600	2.4856 / alloy 625	2.4610, 2.4819 / alloy C-4, C-246	2.4360 / alloy 400	2.0882 / alloy CuNi 70/30	Tombac	Bronze	Copper	Nickel	Titanium	Tantalum	Aluminium	Silver	
	Hydrazine sulphate hy (NH ₂) ₂ H ₂ SO ₄	10	bp	3	3	3	3	3	3	3	3	3	3	3	3	3	3	3	3	3	3	3
Hydrobromic acid aqueous solution of hydrogen bromide (HBr)		20	3	3	3	3	3	3	3	3	3	3	3	3	3	3	3	3	3	3	3	3
Hydrochloric acid HCl	0.2 0.5 0.5 1 2 5 15 32 32	20 bp bp 20 65 20 20 20 bp	3 3 3 3 3 3 3 3 3	3 3 3 3 3 3 3 3 3	P P P P P P P P P	P P P P P P P P P			3	3		0	0	0	0	0	0	0	0	0	0	0
Hydrochloric-acid gas see hydrogen chloride																						
Hydrofluoric acid HF	10 80 80 90	20 20 bp 30	3 3 3 3	3 3 3 3	3 3 3 3	3 3 3 3	1 1 1 1	1 1 1 1	0 0 0 0	0 0 0 0	0 0 0 0	3	3	3	3	3	1	3	3	3	3	
Hydrogen H		<300 >300	0 3	0 0	0 0	0 0									0	0					0	0
Hydrogen bromide HBr dr mo	100 30	20 30	0 3	0 3	0 3	0 3														0		
Hydrogen chloride HCl dr dr dr		20 100 250 500	0 3 1 3	3 3 3 3	1 3 3 3	1 3 3 3	0 0 0 0	0 0 0 0	0 0 0 0	0 0 0 0	0 0 0 0			3	3	3	3	3	3	3	3	
Hydrogen cyanide HCN dr hy hy	20 20 20	30 10 30	3 0 3	0 1 0	0 0 0	0 0 0	0 0 0	1 0 0	0 0 0	0 0 0	0 0 0	1	0	3	3	3	3	1	0	0	0	0
Hydrogen fluoride HF	5 100	20 500	3 3	3 3	3 3	3 3	3 3	0 3	0 3	0 3	0 3			3	3	3	3	0	3	3	3	
Hydrogen peroxide H ₂ O ₂	all	20	3	3	0	0	0	1	0	0	1	3	3	3	3	3	3	3	1	3	0	0

7.4 Corrosion resistance

Resistance table

Medium			Materials																
Designation Chemical formula	Concentration %	Temperature C	Non-/low- alloy steels																
			Stainless steels			Nickel alloys				Copper alloys			Pure metals						
			Ferritic steels	Austenitic steels	Austenitic + Mo	2.4888 / alloy steels	8252.4816 / alloy 600	2.4856 / alloy 625	2.4610, 2.4819 / alloy C-4, C-2.46	2.4360 / alloy 400	2.0882 / alloy CuNi 70/30	Tombac	Bronze	Copper	Nickel	Titanium	Tantalum	Aluminium	Silver
Hydrogen sulphide H ₂ S	dr dr dr mo	100 100 200 100	20 3 3 3	1 3 3 3	S S S S	0 0 0 0	0 0 0 0	0 0 0 0	0 0 0 0	1 0 0 0	0 0 0 0	1 0 0 0	0 0 0 0	0 0 0 0	0 0 0 0	0 0 0 0	0 0 0 0	1 0 0 3	
Hydroiodic acid	dr mo		20 3	0 3	0 3	0 3	0 3												
Hypochlorous acid HOCl			20	3	3	3	3											0	3
Indol			20	0	0	0	0	0	0	0	0	0	0	0	0	0	0	0	0
Ink see gallic acid																			
Iodine J ₂	dr mo	100	20 bp	0 3	P 3	P 3	P 3						0 1 1	0 3 3	3 3 3	3 3 3	3 3 3	3 3 3	0 3 3
Iodoform CHJ ₃	dr mo		60 20	0 3	0 3	0 P	0 P												0
Iron (II) chloride FeCl ₂	hy hy	10 cs	20	0		P	P			3	3		1 0	3 3	1 3	3 3	1 3	3 3	0 0
Iron (II) sulphate FeSO ₄	hy	all	bp	0	0	0	0			0	0		0	0				3	0
Iron (III) chloride FeCl ₃	dr hy hy hy	100 5 10 50	20 3 65 20	0 3 3 3	P 3 1 3	P 3 1 3	P 3 1 3	1 3 3 3	3 3 3 3	3 3 3 3	3 3 3 3	3 3 3 3	0 0 0 0	0 0 0 0	0 0 0 0	0 0 0 0	0 0 0 0	3 3 3 3	
Iron (III) nitrate Fe(NO ₃) ₃	hy hy	10 all	20 bp	3 3	0 0	0 0	0 0	3 3	3 3	0 0	0 0	3 3	3 3	3 3	3 3	0 0	0 0	3 3	0 0
Iron (II) sulphate FeSO ₄	hy	all	bp	0	0	0	0			0	0		0	0				3	0
Iron (III) sulphate Fe(SO ₄) ₃	hy hy	<30 all	20 bp	3 3	0 1	0 0	0 0	0 0	3 0	0 0	0 0	1 0	3 0	3 0	3 0	3 0	0 0	0 3	3 3
Isatine C ₈ H ₉ NO ₂			20	1	0	0	0	0	0	0	0	0	0	0	0	0	0	0	0

7.4 Corrosion resistance

Resistance table

Medium			Materials																
Designation Chemical formula	Concentration %	Temperature C	Non-/low- alloy steels																
			Stainless steels			Nickel alloys				Copper alloys			Pure metals						
			Ferritic steels	Austenitic steels	Austenitic + Mo	2.4888 / alloy steels	8252.4816 / alloy 600	2.4856 / alloy 625	2.4610, 2.4819 / alloy C-4, C-2.46	2.4360 / alloy 400	2.0882 / alloy CuNi 70/30	Tombac	Bronze	Copper	Nickel	Titanium	Tantalum	Aluminium	Silver
Kalinite see alum																			
Ketene R ₂ C=C=O			20 bp	0	0	0	0	0	0	0	0	0	0	0	0	0	0	0	0
Lactic acid C ₃ H ₆ O ₃	hy all 10 all	20 3 bp bp	3 3 3 3	3 3 3 3	0 1 0 0	0 0 0 0	0 0 0 0	0 0 0 0	0 0 0 0	0 0 0 0	0 0 0 0	0 0 0 0	0 0 0 0	0 0 0 0	0 0 0 0	0 0 0 0	0 0 0 0	3 3 3 3	
Lactose C ₁₂ H ₂₂ O ₁₁	hy		20	0	0	0	0	0	0	0	0	0	0	0	0	0	0	0	0
Lead Pb	me		388 900	3 3	1 3	1 3	1 3			0	0	3						3	0
Lead acetate (CH ₃ -COO) ₂ Pb	me			3	0	0	0			0	0						3	3	3
Lead acide Pb(N ₃) ₂		<20	<30							0	0	0	1					1	
Lead nitrate Pb(NO ₃) ₂	hy		100	1	0	0	0	0	0	0	0	0	0	0	0	0	0	0	0
Lime see calcium oxide																			
Lithium Li	me		300	0	0	0	0	0	0	0	0	0	0	3	3	3	3	3	0
Lithium chloride LiCl	hy	cs		3	3	3	P	0	0	0	0	1						0	0
Lithium hydroxide LiOH	hy	all	20	1	0	0	0	0	0	0	0	0	0					0	0
Magnesium Mg	me		650	1	3	3	3	3	3	3	3	3	3	3	3	3	3	3	0
Magnesium carbonate MgCO ₃	hy hy		20 bp	0 0	0 0	0 0	0 0	0 0	0 0	0 0	0 0	0 0	0 0	0 0	0 0	0 0	0 0	0 0	1 1

7.4 Corrosion resistance

Resistance table

Medium			Materials																	
Designation Chemical formula	Concentration		Non-/low- alloy steels	Stainless steels			Nickel alloys				Copper alloys			Pure metals						
	%	C		Ferritic steels	Austenitic steels	Austenitic + Mo	steels 2.4858 / alloy	8252.4816 / alloy 600	2.4856 / alloy 625	2.4610, 2.4819 / alloy C-4, C-2.46	2.4360 / alloy 400	2.0882 / alloy CuNi 70/30	Tombac	Bronze	Copper	Nickel	Titanium	Tantalum	Aluminium	Silver
Magnesium chloride MgCl ₂	hy hy hy	5 5 50	20 bp bp	3 3 3	3 3 3	P P P	P P P	0 0 0	0 0 0	0 0 0	0 0 0	3 3 3		3 3 3	0 0 0	0 0 0	0 0 0	0 0 0	3 3 3	
Magnesium hydroxide Mg(OH) ₂	hy hy	cs sa		0 0	0 0	0 0	0 0	0 0	0 0	0 0	0 0	0 0	0 0	0 0	0 0	0 0	0 0	0 0	3 3	
Magnesium nitrate Mg(NO ₃) ₂		cs		0 0	0 0	0 0	3 3	3 3	3 3	0 0	3 3	0 0	0 0	3 3	0 0	0 0	0 0	0 0	1	
Magnesium oxide see magnesium hydroxide																				
Magnesium sulphate MgSO ₄	hy hy hy	0.1 5 50	20 20 bp	0 3 3	1 1 1	0 0 0	0 0 0	0 1 0	0 0 1	0 0 1	0 3 3	0 0 0	0 0 0	1 1 1	0 0 0	0 0 0	0 0 0	0 0 0	3 0 0	
Maleic acid HOOC-CH=CH-COOH	hy hy	5 50	20 100	3 3	0 0	0 0	0 0	0 1	0 0	0 0	1 0	0 0		1					0 0	
Maleic anhydride		100	285					0												
Mallic acid	hy hy	50	20 3	3 3	3 3	0 0	0 0	0 1	0 0	0 1	3 3	3 3	3 3	3 3	0 0	0 0	0 0	0 0	0 0	
Malonic acid CH ₂ (COOH) ₂		20 50 100		1 1 1	1 1 1	1 1 1	1 1 1	1 1 1	1 1 1	1 1 1	3 3 3				1 1 1	1 1 1			1	
Manganese(II) chloride MnCl ₂	hy hy	5 50	100 20	3 1	P P P	P P P	1 1 1	1 1 1	1 1 1	1 1 1	3 3 3			3 3 3	1 1 1	0 0 0	0 0 0			
Manganese(II) sulphate MnSO ₄		cs		0 0	0 0	0 0	0 0	0 0	0 0	0 0				0 0	0 0					
Maritime climate	mo			2P 1P 1P	0 0 0	0 0 0	0 0 0	0 0 0	0 0 0	0 0 0	1 0 0	0 0 0	0 0 0	0 0 0	0 0 0	0 0 0	0 0 0	0 0 0	2 1	
Methanol see methyl alcohol																				
Menthol C ₁₀ H ₁₈ OH				0 0	0 0	0 0	0 0	0 0	0 0	0 0	0 0	0 0	0 0	0 0	0 0	0 0	0 0	0 0	0	

7.4 Corrosion resistance

Resistance table

Medium			Materials																	
Designation Chemical formula	Concentration		Non-/low- alloy steels	Stainless steels			Nickel alloys				Copper alloys			Pure metals						
	%	C		Ferritic steels	Austenitic steels	Austenitic + Mo	steels 2.4858 / alloy	8252.4816 / alloy 600	2.4856 / alloy 625	2.4610, 2.4819 / alloy C-4, C-2.46	2.4360 / alloy 400	2.0882 / alloy CuNi 70/30	Tombac	Bronze	Copper	Nickel	Titanium	Tantalum	Aluminium	Silver
Mercury Hg	dr	100 all	<200 500	0 1	P P	P P	0 0	0 0	0 0	0 0	3 3	3 3	3 3	3 3	0 0	0 0	0 0	0 0	1 3	3
Methane CH ₄			200 600	0 0	0 0	0 0	0 0	0 0	0 0	0 0	0 0	0 0	0 0	0 0	0 0	0 0	0 0	0 0	0	
Methyl acetate CH ₃ COOCH ₃		60 60	20 bp	0 0	0 0	0 0			0 0									0 0	0 0	
Methyl alcohol CH ₃ OH		<100 100	20 bp	1 3	0 1	0 1	0 0	0 0	0 0	0 0	0 0	0 0	0 0	0 0	0 0	0 0	0 0	0 0	1 1	0
Methylamine CH ₃ -NH ₂	hy	25	20	1 0	0 0	0 0	0 0	0 0	0 0	3 3	3 3	3 3	3 3	3 3	0 0	0 0	0 0	0 0	0	
Methyl chloride CH ₂ Cl	dr mo mo	100	20 20 100	0 3 100	P P P	P P P	0 0 0	0 0 0	0 0 0	0 0 0	0 0 0	0 0 0	0 0 0	0 0 0	0 0 0	0 0 0	0 0 0	0 0 0	0 3 3	
Methyldehyde see formaldehyde																				
Methylene dichloride CH ₂ Cl ₂	dr mo mo		20 20 bp	0 P P	P P P	P P P	0 1 1	1 1 1	1 1 1	1 1 1	0 0 0				0 0 0	1 1 1	0 0 0	0 0 0	0 3 3	
Milk of lime Ca(OH) ₂			20 bp	0 0	1 1	0 0	0 0												0 0	
Milk sugar see lactose																				

7.4 Corrosion resistance

Resistance table

Medium			Materials																		
Designation Chemical formula	Concentration	Temperature	Non-/low- alloy steels		Stainless steels		Nickel alloys				Copper alloys		Pure metals								
			Ferritic steels	Austenitic + Mo	Ferritic steels	Austenitic + Mo	steels 2.4858 / alloy 8252.4816 / alloy 600	2.4856 / alloy 625	2.4610, 2.4819 / alloy C-4, C-2.46	2.4360 / alloy 400	2.0882 / alloy CuNi 70/30	Tombac	Bronze	Copper	Nickel	Titanium	Tantalum	Aluminium	Silver		
	%	°C																			
Mixed acids																					
HNO ₃																					
H ₂ SO ₄																					
H ₂ O																					
%																					
90	20	0																			
50	20	0																			
50	90	3																			
50	50	0																			
38	60	0																			
25	75	0																			
25	75	0																			
15	20	3																			
15	20	3																			
10	70	3																			
10	70	3																			
5	30	3																			
5	30	3																			
5	30	3																			
5	65	3																			
5	15	134																			
Molasses																					
Monochloroacetic acid see chloroacetic acid																					
Naphthaline C ₁₀ H ₈	100 100	20 390	0 0	0 0	0 0	0 0															
Naphthaline chloride	100 100	45 200																			
Naphthaline sulphonic acid C ₁₀ H ₇ SO ₂ H	100 100	20 bp	0		3	3	3														
Naphthenic acid	hy	100	20	P	P	P	0	0	0	0											
Nickel (II) chloride NiCl ₂	hy hy	10 10 tot	20 bp 70	3 3 3	P P P	P P 0	0	1	0	0	1	1	3	1	3	1	0	0			0
Nickel (II) nitrate Ni(NO ₃) ₂	hy hy	10 25 <100	25 3 3	0 0 0	0 0 0	0 0 0	0	0	0	0	3	3	3	3	3	3	0	0	0	3	3
Nickel (II) sulphate NiSO ₄	hy hy	20 bp	3 3	0 0	0 0	0 0	0	1	1	1	1	1	1	3	3	0	0	0			0

7.4 Corrosion resistance

Resistance table

Medium			Materials																		
Designation Chemical formula	Concentration	Temperature	Non-/low- alloy steels		Stainless steels		Nickel alloys				Copper alloys		Pure metals								
			Ferritic steels	Austenitic + Mo	Ferritic steels	Austenitic + Mo	steels 2.4858 / alloy 8252.4816 / alloy 600	2.4856 / alloy 625	2.4610, 2.4819 / alloy C-4, C-2.46	2.4360 / alloy 400	2.0882 / alloy CuNi 70/30	Tombac	Bronze	Copper	Nickel	Titanium	Tantalum	Aluminium	Silver		
	%	°C																			
Nitric acid HNO ₃	1 1 5 5 10 15 25 25 65 65 99 20 40	20 bp 20 bp bp bp bp bp 20 20 290 200	3 3 3 3 3 3 3 3 3 3 3 3 3	0 0 0 0 0 0 0 0 0 0 0 0 0	0 0 0 0 0 0 0 0 0 0 0 0 0	0 0 0 0 0 0 0 0 0 0 0 0 0															
Nitrobenzene C ₆ H ₅ (NO ₂) _y	hy			0	0	0	0	0	0	0	0	0	0	0	0	0	0	0	0	0	0
Nitrobenzoic acid C ₆ H ₄ (NO ₂)COOH	hy		20	1	0	0	0	0	0	0	0	0	0	0	0	0	0	0	0	0	0
Nitroglycerine C ₃ H ₅ (ONO ₂) ₃	hy		20	0	0	0	0														0
Nitrogen N	100 100	20 900	0 1		0	0															0
Nitrous acid HNO ₂ similar to nitric acid																					
Oleic acid see fatty acid																					
Oleum see sulphur trioxide																					
Oxalic acid C ₂ H ₂ O ₄	hy hy hy	all 10 sa	20 bp 3	3 3 3	3 3 3	0 3 3	0	1	1	0	0	0	0	0	0	1	1	1	1	1	1
Oxygen O			500	1	0	0	0									0	3	3			0
Ozone					0	0	0	0	0	0	0	0	0	0	0	0	0	0	0	0	0
Paraffin C _n H _{2n+2}	me		20 120	0 0	0 0	0 0										0	0	0	0	0	0

7.4 Corrosion resistance

Resistance table

Medium		Materials																			
Designation Chemical formula	Concentration	Temperature	Stainless steels			Nickel alloys			Copper alloys			Pure metals									
	%	°C	Non-/low- alloy steels	Ferritic steels	Austenitic steels	Austenitic + Mo	steels 2.4858 / alloy 8252.4816 / alloy 600	2.4856 / alloy 625	2.4610.2.4819 / alloy C-4, C-2.46	2.4360 / alloy 400	2.0882 / alloy CuNi 70/30	Tombac	Bronze	Copper	Nickel	Titanium	Tantalum	Aluminium	Silver		
Perchloroethane see hexachlorethane																					
Perchloric acid (60%) HClO ₄	10 100	20 20	3 3	3 3	3 3	3 3													0 0	3	
Perchloroethylene C ₂ Cl ₄ mo		20 bp	0 0	0 1	0 1	0 1					0 1	0 1	0 0	0 0	0 0					0 3	
Perhydro see hydrogen superoxide																					
Petroleum		20 bp	0 0	0 0	0 0	0 0	0 0	0 0	0 0	0 0	1 1	0 0	0 0	0 0	0 3	0 0				0 0	
Petrol see benzene (benzene)																					
Phenol see carbolic acid																					
Phloroglucinol C ₆ H ₃ (OH) ₃		20		0	0	0	0	0	0	0					0	0	0				
Phosgene COCl ₂ dr		20		0	0	0	0	0	0	0					0	0	0				
Phosphoric acid H ₃ PO ₄ hy hy hy hy hy	1 10 30 60 80 80	20 20 bp bp 3 bp	3 3 3 3 3	0 3 3 3 3	0 1 1 3 3	0 0 1 3 3	0 0 1 1 3	0 0 1 1 3	1 1 1 1 3	3			1	3	0 3 3 3 3	0 0 0 0 0	0 0 0 0 0	0 0 0 0 0	3		0 1
Phosphorous P dr		20	0	0	0	0															
Phosphorous pentachloride PCl ₅ dr	100	20	0	0	0									0	1						
Phtalic acid and phtalic anhydride C ₆ H ₄ (COOH) ₂ dr		20 200 bp	0	0	0	0		0	0	0	0	0	0	0	0				0	0	0

7.4 Corrosion resistance

Resistance table

Medium		Materials																		
Designation Chemical formula	Concentration	Temperature	Stainless steels			Nickel alloys			Copper alloys			Pure metals								
	%	°C	Non-/low- alloy steels	Ferritic steels	Austenitic steels	Austenitic + Mo	steels 2.4858 / alloy 8252.4816 / alloy 600	2.4856 / alloy 625	2.4610.2.4819 / alloy C-4, C-2.46	2.4360 / alloy 400	2.0882 / alloy CuNi 70/30	Tombac	Bronze	Copper	Nickel	Titanium	Tantalum	Aluminium	Silver	
Picric acid C ₆ H ₃ (OH)(NO ₂) ₃ hy hy me	3 cs 150	20 150	3 3 3	0 0 0	0 0 0	0 0 0	3 3		0 3	3 3	3 3	3 3	3 3	3 3	3 3	0 0 0	0 0 0	1 0 3	0	
Plaster see calcium sulphate																				
Potash lye see potassium hydroxide																				
Potassium K me		604 800		0	0	0				1						0	0	1	0	0
Potassium acetate CH ₃ -COOK me hy	100	292 20	1	0	0	0				0	0	0	0	1	1	0	0	0		
Potassium bisulphate KHSO ₄ hy hy	5 5	20 90	3 3	3 3	2 3	0 3												0 3		
Potassium bitartrate KC ₄ H ₅ O ₆ hy hy	cs sa		3 3	3 3	0 3	0 1										0 1	0 0	0 0	0 0	
Potassium bromide KBr hy	5	30	3	P	P	P	0	1	0	0	1	0	0	0	0	0	0	0	0	3
Potassium carbonate K ₂ CO ₃ hy hy	50 50	20 bp	1 3	0 3	0 0	0 0	0 0	0 0	0 0	0 0	1 3	3 3	1 1	1 1	0 3	0 0	0 0	0 0	3 3	0 0
Potassium chlorate KClO ₃ hy hy	5 sa	20 30	3 3	0 0	0 0	0 0	0 0	1 3	0 0	0 0	3 3	1 3	1 1	1 3	0 0	0 0	0 0	0 1		
Potassium chloride KCl hy hy hy hy hy	10 10 30 cs sa	20 bp bp 3 3	3 3 3 3 3	3 3 3 P P	3 3 3 P P	3 3 3 P P	0 0 0 1 1	0 0 0 0 0	0 0 0 0 0	0 0 0 0 0	0 0 0 0 0	3 3 3 1 1	3 1 3			0		1 1 0	0	
Potassium chromate K ₂ CrO ₄ hy hy	10 10	20 bp	0 1	0	0	0	0	0	0	0	0	0	0	0	0	0	0	0	0	0
Potassium cyanide KCN hy hy	10 10	20 bp	3 3	0 0	0 0	0 0	0	3	0	1	3	3	3	3	3	0	0	0	3	3

7.4 Corrosion resistance

Resistance table

Medium			Materials														
Designation Chemical formula	Concentration %	Temperature C	Non-/low- alloy steels														
			Stainless steels			Nickel alloys				Copper alloys			Pure metals				
			Ferritic steels	Austenitic steels	Austenitic + Mo	steels 2.4858 / alloy 8252.4816 / alloy 600	2.4856 / alloy 625	2.4610.2.4819 / alloy C-4, C-2.46	2.4360 / alloy 400	2.0882 / alloy CuNi 70/30	Tombac	Bronze	Copper	Nickel	Titanium	Tantalum	Aluminium
Potassium dichromate K ₂ Cr ₂ O ₇	hy hy hy	10 25 40 25	40 40 40 bp	3 3 3 3	0 0 0 0	0 0 0 0	1 1 1 1	1 1 1 1	1 1 1 1	0 0 0 0	3 3 3 3	3 3 3 3	1 0 0 0	0 0 0 0	0 0 0 0	0 0 0 0	0
Potassium ferricyanide K ₃ (Fe(CN) ₆)	hy hy hy	1 cs sa	20	0 3	0 0	0 P	1 0	0 0	0 0	0 0	0 0	0 0	0 0	0 0	0 0	0 0	3 3
Potassium ferrocyanide K ₄ (Fe(CN) ₆)	hy hy hy	1 25 25	20 20 bp	0 1	0 1	0 0	1 0	1 0	0 0	0 0	0 0	0 0	0 0	0 0	0 0	0 0	3 3
Potassium fluoride KF	hy hy	cs sa		0 1	0 0	0 0	0 0	0 0	0 0	0 0	0 0	0 0	0 0	0 0	0 0	3 3	
Potassium hydroxide KOH	hy hy hy hy hy hy me	10 20 30 50 50 sa 100	20 bp bp 20 20 360	0 3 S S S S	S S S S	S S S S	1 1 1 1	1 1 1 1	0 0 0 0	0 3 3 3	3 3 3 3	3 3 3 3	0 0 0 0	0 3 3 3	0 3 3 3	3 3 3 3	0
Potassium hypochloride KClO	hy hy	all all	20 bp	P P	P P	P P	3 3	3 3	0 1	3 3	3 3	3 3	0 3	0 0	0 0	3 3	
Potassium iodide KI	hy hy		20 bp	0 0	P P	P P	0 0	1 1	1 1	0 0	3 3	0 0	0 3	0 0	0 0	3 3	
Potassium nitrate KNO ₃	hy hy	all all	20 bp	0 0	0 0	0 0	0 0	1 1	1 1	1 1	1 0	1 0	1 0	0 0	0 0	0 1	
Potassium nitrite KNO ₂		all	bp	1	0	0	0	1	0	0	0	0	1	1	1	1	
Potassium permanganate KMnO ₄	hy hy	10 all	20 bp	0 3	0 1	0 1	0 1	1 1	1 1	0 0	1 0	1 0	0 0	0 0	0 0	0 0	3
Potassium persulphate K ₂ S ₂ O ₈	hy	10	50	3	3	0	0	0	0	3	3	3	3	0	0	3	3
Potassium silicate K ₂ SiO ₃			20	1	0	0	0	0	0	0	0	0	0	0	0	3	
Potassium sulphate K ₂ SO ₄	hy hy	10 all	25 bp	3 0	0 0	0 0	0 0	0 0	0 0	0 0	0 0	1 0	0 0	0 0	0 0	0 1	

7.4 Corrosion resistance

Resistance table

Medium			Materials														
Designation Chemical formula	Concentration %	Temperature C	Non-/low- alloy steels														
			Stainless steels			Nickel alloys				Copper alloys			Pure metals				
			Ferritic steels	Austenitic steels	Austenitic + Mo	steels 2.4858 / alloy 8252.4816 / alloy 600	2.4856 / alloy 625	2.4610.2.4819 / alloy C-4, C-2.46	2.4360 / alloy 400	2.0882 / alloy CuNi 70/30	Tombac	Bronze	Copper	Nickel	Titanium	Tantalum	Aluminium
Protein solutions			20	1	0	0	0	0	0	0	0	0	0	0	0	0	0
Pyridine C ₅ H ₅ N	dr	all all	20 bp	0 0	0 0	0 0	0 0	0 0	0 0	0 0	0 0	0 0	0 0	0 0	0 0	0 0	0
Pyrogallol C ₆ H ₃ (OH) ₃		all all	20 bp	3 3	0 0	0 0	0 0	0 0	0 0	0 0	0 0	0 0	0 0	0 0	0 0	0 0	0
Quinine bisulphate	dr		20	3	3	3	0	0	0	0	0	1	0	0	0	0	
Quinine sulphate	dr		20	3	0	0	0	0	0	0	0	0	1	0	0	0	
Quinol HO-C ₆ H ₄ -OH				3	0	0	0	0	0	0	0	1	0	0	0	0	
Salicylic acid HO-C ₆ H ₄ -COOH	dr mo hy	100 100 cs	20	1 3 3	0 0 0	0 0 0	0 0 0	1 1 0	0 1 0	0 0 0	0 0 0	1 0 0	0 0 0	0 0 0	0 0 0	0 0 1	0
Salmiac see ammonium chloride																	
Salpetre see potassium nitrate																	
Seawater at flow velocity v (m/s) 0 < v ≤ 1.5 1.5 < v < 4.5			20 20	1 1	P P	P P	P P	P P	P P	P P	P P	P P	1 0	0 0	1 0	0 0	1 3
Siliceous flux acid see fluorsilicic acid																	
Silver nitrate AgNO ₃	hy hy hy hy me	10 10 20 40 100	20 bp 60 20 250	3 3 3 3 3	0 0 0 0 0	0 0 0 0 0	0 0 0 0 0	1 1 1 1 1	1 1 1 1 1	1 1 1 1 1	1 1 1 1 1	1 1 1 1 1	0 0 0 0 0	0 0 0 0 0	0 0 0 0 0	0 0 0 0 0	3
Soap	hy hy hy	1 1 10	20 75 20	0 0 0	0 0 0	0 0 0	0 0 0	0 0 0	0 0 0	0 0 0	0 0 0	0 0 0	0 0 0	0 0 0	0 0 0	0 0 0	0
Sodium (O ₂ ≤ 0.005 %) Na	me		200 600	0 3	0 1	0 0	0 0	0 0	0 0	0 0	0 0	0 0	0 0	0 0	0 0	0 0	1

7.4 Corrosion resistance

Resistance table

Medium		Concentration		Temperature		Materials																	
Designation	Chemical formula	%	C	Non-/low- alloy steels			Stainless steels			Nickel alloys				Copper alloys		Pure metals							
				Ferritic steels	Austenitic steels	Austenitic + Mo	Ferritic steels	Austenitic steels	Austenitic + Mo	2.4858 / alloy steels	8252.4816 / alloy 600	2.4856 / alloy 625	2.4610, 2.4819 / alloy C-4, C-2.46	2.4360 / alloy 400	2.0882 / alloy CuNi 70/30	Tombac	Bronze	Copper	Nickel	Titanium	Tantalum	Aluminium	Silver
Sodium perborate	hy NaBO ₂	10	20	3	0	0	0	0			1							1					
Sodium perchlorate	hy NaClO ₄	10	20	3	3	0	0	0	1		1							0					
Sodium peroxide	hy Na ₂ O ₂	10	20	3	1	0	0	0	1	1	1	0	3		3	0	3	3	3	3	3	3	3
Sodium phosphate	hy Na ₂ HPO ₄	10	20	0	0	0	0	0	0	0	0	0	0	0	3	1	1	0	0	0	0	1	
Sodium salicylate	hy C ₆ H ₄ (OH)COONa	all	20	0	0	0	0	0	0	0	0	0	0	0	0	0	0	0	0	0	0	0	0
Sodium silicofluoride	hy Na ₂ (SiF ₃)	cs		3	3	3	3	0	0	1	1	0										1	
Sodium sulphate	hy Na ₂ SO ₄	10	20	3	0	0	0	0	0	0	0	0	0	0	0	0	0	0	0	0	0	0	0
Sodium sulphide	hy Na ₂ S	1	20	3	0	0	0	0	0	0	0	1						1	0	0	0	1	
Sodium sulphite	hy Na ₂ SO ₃	10	20	3	1	0	0	0	0	0	1	3	1	1				0	0	0	0	3	
Sodium superoxide	see sodium peroxide																						
Sodium tetraborate	see borax																						
Sodium thiosulphate	hy Na ₂ S ₂ O ₃	1	20	1	0	0	0	0			0							0	0	0	0	0	0
Spirit of turpentine	100	20	3	0	0	0	0				0	1	0	0	0	0	0	0	0	0	0	0	0

7.4 Corrosion resistance

Resistance table

Medium		Concentration		Temperature		Materials																	
Designation	Chemical formula	%	C	Non-/low- alloy steels			Stainless steels			Nickel alloys				Copper alloys		Pure metals							
				Ferritic steels	Austenitic steels	Austenitic + Mo	Ferritic steels	Austenitic steels	Austenitic + Mo	2.4858 / alloy steels	8252.4816 / alloy 600	2.4856 / alloy 625	2.4610, 2.4819 / alloy C-4, C-2.46	2.4360 / alloy 400	2.0882 / alloy CuNi 70/30	Tombac	Bronze	Copper	Nickel	Titanium	Tantalum	Aluminium	Silver
Spirits			20	1	0	0	0	0	0	0	0	0	0	0	0	0	0	0	0	0	0	0	0
Steam	O ₂ < 1 ppm; Cl < 10 ppm O ₂ > 1 ppm; Cl < 10 ppm O ₂ > 15 ppm; Cl < 3 ppm		< 560 < 315 > 450	1 S S	1 S S	1 S S	0 S S			0	0	0	0	0	0	0	0	0	0	0	0	0	0
Stearic acid	CH ₂ (CH ₂) ₁₆ COOH	100	20	1	0	0	0	0	0	0	0	0	0	0	0	0	0	0	0	0	0	0	0
Succinic acid	HOOC-CH ₂ -CH ₂ -COOH	100	95	3	0	0	0	0	0	0	0	0	0	0	0	0	0	0	0	0	0	0	0
Sulphur S	dr me me mo	100	60	0	0	0	0	0	0	0	0	0	0	0	0	0	0	0	0	0	0	0	3
Sulphur dioxide SO₂	dr dr dr mo mo mo	100	20	0	0	0	0	0	0	0	0	0	0	0	0	0	0	0	0	0	0	0	0
Sulphuric acid H₂SO₄		0.05 0.05 0.1 0.2 0.8 1 3 5 7.5 10 25 25 40 40 50 50	20	3	1	0	0	0	0	0	0	0	0	0	0	0	0	0	0	0	0	0	0

7.4 Corrosion resistance

Resistance table

Medium			Materials													
Designation Chemical formula	Concentration %	Temperature C	Non-/low- alloy steels													
			Stainless steels			Nickel alloys				Copper alloys			Pure metals			
	Ferritic steels	Austenitic steels	Austenitic + Mo	steels 2.4858 / alloy 8252.4816 / alloy 600	2.4856 / alloy 625	2.4610, 2.4819 / alloy C-4, C-246	2.4360 / alloy 400	2.0882 / alloy CuNi 70/30	Tombac	Bronze	Copper	Nickel	Titanium	Tantalum	Aluminium	Silver
Sulphuric acid H ₂ SO ₄	60 80 90 96	20	3 3 3 1	3 3 3 1	3 3 3 0			0 0 0 0	1 3 3 3	3 3 3 1	3 1 3 1	0 3 3 3	0 0 0 0	0 0 0 0	0 0 0 0	0
Sulphurous acid H ₂ SO ₃	hy cs sa	20	3 3 3 3	3 3 3 3	0 0 0 1	1		0 0 0 1	3 3 3 3			3	1 0 0 0	0 0 0 0	1 3 3 3	
Sulphur trioxide SO ₃	hy dr	100 20	0			2 3		0 3	2 0	0 0	0 0	3 3			3 0	
Tannic acid C ₇₆ H ₅₂ O ₄₆	hy hy hy	5 25 50	20 100 30	3 3 3	0 3 0	0 0 0	0	0	0 1	0 0	0 0	0 0	0 0	0 0	0	
Tar		20	0	0	0				0 1	0 0	0 0	0 0			1	
Tartaric acid	hy hy hy hy hy hy	10 10 25 25 50 50	20 bp 30 30 20 bp	1 3 3 3 3 3	0 1 1 1 0 3	0 0 0 0 0 0	0 1 0 3 0 1 0 1 0 1 0 1	0 1 0 3 0 1 0 1 0 0 0 1	0 3 0 3 0 3 0 3 0 3 0 3	0 0 0 0 0 1 0 1 0 0 0 0	1 3 1 3 1 3 1 3 1 3 1 3	0 3 0 3 0 3 0 3 0 3 0 3	1 3 1 3 1 3 1 3 1 3 1 3	0 0 0 0 0 0 0 0 0 0 0 0	3 3 3 3 3 3 3 3 3 3 3 3	
Tetrachloroethane see acetylen tetrachloride																
Tetrachloroethylene pure pure mo mo	100 100	20 20 20 bp	0 3 3 3	0 3 3 3	0 P P P			0 0 0 0	0 1 3 1	0 1 1 1	0 1 1 1	0 0 0 0	0 0 0 0	0 0 0 0	0 3 3 3	
Tin chloride SnCl ₂ ; SnCl ₄	5 sa	20	3 3	3 3	3 3	3 3	3 3	0 1	3			1 0	0 0	3		
Toluene C ₆ H ₅ -CH ₃	100 100	20 bp	0 0	0 0	0 0			0 0	0 0	0 0	0 0	0 0	0 0	0 0	0 0	
Town gas			0	0	0	0	0 0 0	0 1 1	0 0 1	1 1						
Trichloroacetaldehyde see chloral																
Trichloroethylene CHCl=CCl ₂	pure pure mo mo	100 100	20 20 20 bp	0 3 3 3	0 3 3 P	0 P P P		0 0 0 0	0 1 3 1	0 1 1 1	0 0 0 0	0 0 0 0	0 0 0 0	0 0 0 0	0 3 3 3	

7.4 Corrosion resistance

Resistance table

Medium			Materials													
Designation Chemical formula	Concentration %	Temperature C	Non-/low- alloy steels													
			Stainless steels			Nickel alloys				Copper alloys			Pure metals			
	Ferritic steels	Austenitic steels	Austenitic + Mo	steels 2.4858 / alloy 8252.4816 / alloy 600	2.4856 / alloy 625	2.4610, 2.4819 / alloy C-4, C-246	2.4360 / alloy 400	2.0882 / alloy CuNi 70/30	Tombac	Bronze	Copper	Nickel	Titanium	Tantalum	Aluminium	Silver
Trichloromethane see chloroform																
Tricresylphosphate			0	0	0	0	0	0	0	0	0	0	0	0	0	0
Trinitrophenol see picric acid																
Trichloroacetic acid see chloroacetic acid																
Urea CO(NH ₂) ₂	100 100	20 150	0 3	0 0	0 1	0		3	0 1	0 1	0 0	0 0	0 0	0 0	0 3	1
Uric acid C ₅ H ₄ O ₃ N ₃	hy hy	20 100	3 3	0 0	0 0	0	0 1	0 0	0 0	0 0	0 0	0 0	0 0	0 0	1 3	3
Vinyl chloride CH ₂ =CHCl	dr	< 400	0	0	0			0	0	0	0	0	0	0	0	
Water vapour see steam																
Wine		20 bp	3 3	0 0	0 0			0	0	0	0	0	0	0	3 3	3 3
Yeast		20	1	0	0	0	0	0	0	0	0	0	0	0	0	0
Yellow potassium prussiate see potassium ferricyanide																
Zinc chloride ZnCl ₂	hy hy hy hy	5 10 20 75	20 bp 30 20	3 3 3 3	P P P P	P P P P	0 1 0 3	0 1 1 3	1 3 3 3	3 3 3 3	3 3 3 3	3 3 3 3	3 3 3 3	3 3 3 3	3 3 3 3	
Zinc sulphate ZnSO ₄	hy hy hy hy	2 20 30 cs sa	20 bp bp	3 3 3 3	0 0 0 0	0 0 0 0		0 1 1 1	0 1 1 1	0 0 0 0	0 0 0 0	0 0 0 0	0 0 0 0	0 0 0 0	1 0 1 1	0 3 0 3

7.5. Conversion tables and formula symbols

Steam table

Pressure (absolute)	Saturation temperature	Kinematic viscosity of steam	Density of steam
bar	°C	10 ⁶ m ² /s	kg/m ³
p	t	ν ⁿ	ρ ⁿ
0.020	17,513	650,240	0.01492
0.040	28,983	345,295	0.02873
0.060	36,183	240,676	0.04212
0.080	41,534	186,720	0.05523
0.10	45,833	153,456	0.06814
0.14	52,574	114,244	0.09351
0.20	60,086	83,612	0.1307
0.25	64,992	68,802	0.1612
0.30	69,124	58,690	0.1912
0.40	75,886	45,699	0.2504
0.45	78,743	41,262	0.2796
0.50	81,345	37,665	0.3086
0.60	85,954	32,177	0.3661
0.70	89,959	28,178	0.4229
0.80	93,512	25,126	0.4792
0.90	96,713	22,716	0.5350
1.0	99,632	20,760	0.5904
1.5	111.37	14,683	0.8628
2.0	120.23	11,483	1.129
2.5	127.43	9,494	1.392
3.0	133.54	8,130	1.651
3.5	138.87	7,132	1,908
4.0	143.62	6,367	2,163
4.5	147.92	5,760	2,417

7.5. Conversion tables and formula symbols

Steam table

Pressure (absolute)	Saturation temperature	Kinematic viscosity of steam	Density of steam
bar	°C	10 ⁶ m ² /s	kg/m ³
p	t	ν ⁿ	ρ ⁿ
5.0	151.84	5,268	2,669
6.0	158.84	4,511	3,170
7.0	164.96	3,956	3,667
8.0	170.41	3,531	4,162
9.0	175.36	3,193	4,655
10.0	179.88	2,918	5,147
11.0	184.07	2,689	5,637
12.0	187.96	2,496	6,127
13.0	191.61	2,330	6,617
14.0	195.04	2,187	7,106
15.0	198.29	2,061	7,596
20.0	212.37	1,609	10.03
25.0	223.94	1,323	12.51
30.0	233.84	1,126	15.01
34.0	240.88	1,008	17.03
38.0	247.31	0,913	19.07
40.0	250.33	0,872	20.10
45.0	257.41	0,784	22.68
50.0	263.91	0,712	25.33
55.0	269.93	0,652	28.03
60.0	275.55	0,601	30.79
65.0	280.82	0,558	33.62
70.0	285.79	0,519	36.51
75.0	290.50	0,486	39.48

7.5. Conversion tables and formula symbols

Temperatures, saturated steam, pressure

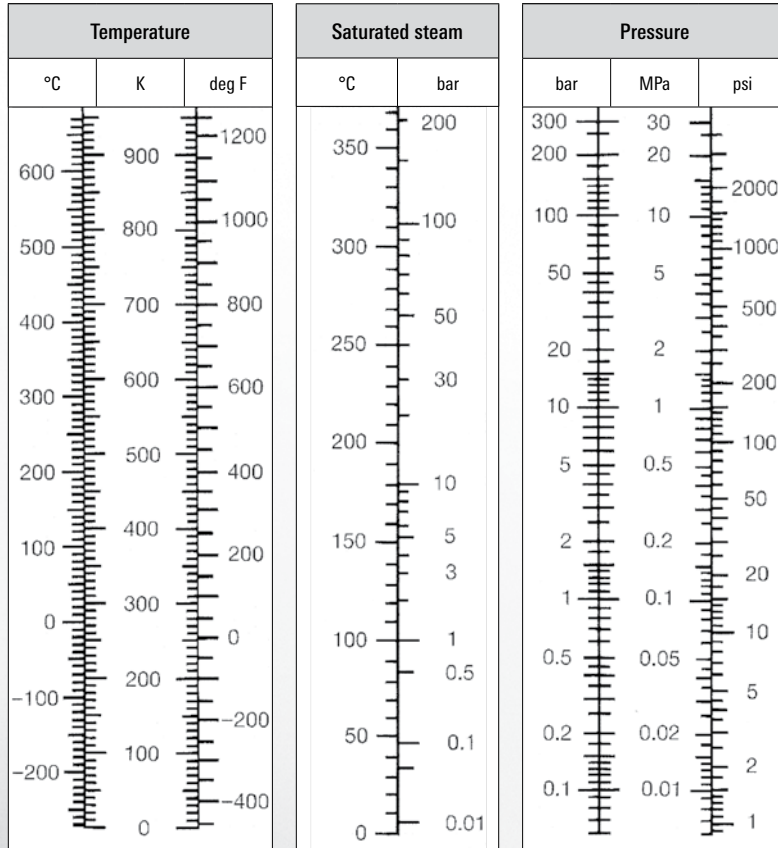

7.5. Conversion tables and formula symbols

Greek alphabet

α	Alpha	A	Alpha
β	Beta	B	Beta
γ	Gamma	Γ	Gamma
δ	Delta	Δ	Delta
ε	Epsilon	E	Epsilon
ζ	Zeta	Z	Zeta
η	Eta	H	Eta
θ θ	Theta	Θ	Theta
ι	Jota	I	Jota
κ	Kappa	K	Kappa
λ	Lambda	Λ	Lambda
μ	My	M	My
ν	Ny	N	Ny
ξ	Xi	Ξ	Xi
ο	Omicron	O	Omicron
π	Pi	Π	Pi
ρ	Rho	P	Rho
σ s	Sigma	Σ	Sigma
τ	Dew	T	Dew
υ	Y	Υ	Y
φ	Phi	Φ	Phi
χ	Chi	X	Chi
ψ	Psi	Ψ	Psi
ω	Omega	Ω	Omega

7.5. Conversion tables and formula symbols

Formula symbols used

Formula symbol	Meaning
A	Hydraulically effective cross-sectional area of hose
A_0	Cross-sectional area of a single wire for braidings
C_W	Weld seam factor to reduce stability
C_1	Pressure reduction coefficient for operating temperatures > 20 °C
D_1	Outside diameter of hose
EI	Flexural stiffness of hose
EL	Fitting length of hose
F	Force, pressure reaction force
L_1	Flexible (corrugated) length of hose (description in accordance with DIN EN ISO 10380: active life length)
NL	Nominal length of hose assembly (corrugated length (ZRL) plus length of end fittings. l)
PN	Rated pressure (permissible operating pressure at 20 °C)
PS	Operating pressure at operating temperature TS
PT	Test pressure (at 20 °C)
Re	Reynold's number
$R_m(T)$	Temperature-dependent tensile strength value
S	Safety factor, general
S_{BB}	Safety factor against breakdown of braiding
S_{BR}	Safety factor against bursting of annularly corrugated hose
T	Temperature
TS	Operating temperature
c	Flow velocity
d_i	Inside diameter of hose

7.5. Conversion tables and formula symbols

Formula symbols used

Formula symbol	Meaning
l	Length of end fittings
n_K	Number of clappers in braiding
n_0	Number of wires per clapper
p	Pressure
Δp	Flow induced pressure loss
s, s_1, s_2	Elevation of hose assembly (the bend amplitude s/2 conforms to the value γ in accordance with DIN EN ISO 10380)
r	Bending radius of the hose
r_N	Nominal bending radius of the hose in accordance with DIN EN ISO 10380
r_{min}	Minimum bending radius with singular bend
γ	Elevation (amplitude) of hose in U-bend test (description according to DIN EN ISO 10380) conforms with the value s/2 in the manual
w (x)	Bend of the hose, x runs in the direction of the hose axis
z	Length of neutral hose end under static lateral load
ZRL	Cut trim length = length of the corrugated section of the hose
α	1.) Bending angle of the hose - incline of the hose ends to each other for determining pressure loss 2.) Bending angle of the hose – deviation of the hose from horizontal/vertical plan with expansion compensation in the 90° bend 3.) Braiding angle
β	Bending angle of the hose – deviation of hose from horizontal/vertical plane with double-sided expansion compensation in the 90° bend
λ	Coefficient of friction for the calculation of pressure loss
ν	Kinematic viscosity of flowing fluid
ρ	Density of flowing fluid
σ_{um}	Mean circumferential stress in annularly corrugated hose
σ_z	Tensile stress in a braided wire
ζ_b	Resistance coefficient for calculation of pressure loss with bent hose installation
ζ	Resistance coefficient of the calculation pressure loss for hose installation in a 180° bend

7.5. Conversion tables and formula symbols

Physical units (D, GB, US)

DIN1301-1, edition 10.2002

SI base units

Size	SI base unit	
	Name	Symbol
Length	Metre	m
Mass	Kilogram	kg
Time	Second	s
Strength of electrical current	Ampere	A
Thermodynamic temperature	Kelvin	K
Quantity of material	Mol	mol
Light intensity	Candela	cd

Prefix symbol

Prefix	Prefix symbol	Factor by which the unit is multiplied
Pico	p	10^{-12}
Nano	n	10^{-9}
Micro	μ	10^{-6}
Milli	m	10^{-3}
Centi	c	10^{-2}
Deci	d	10^{-1}
Deca	de	10^1
Hecto	h	10^2
Kilo	k	10^3
Mega	M	10^6
Giga	G	10^9

7.5. Conversion tables and formula symbols

Length - SI unit metre, m

Symbol	Name	in m
mm	Millimetre	0.0010
km	Kilometre	1000
in	Inch	0.0254
ft	Foot (=12 in)	0.3048
yd	Yard (=3ft / = 36 in)	0.9144

Mass - SI unit kilogram, kg

Symbol	Name	in kg
g	Gram	0.00100
t	Tonne	1000
oz	Ounce	0.02835
lb	Pound	0.4536
sh tn	Short ton (US)	907.20
tn	Ton (UK)	1016

Time - SI unit seconds, s

Symbol	Name	in s
min	Minute	60
h	Hour	3600
d	Day	86400
a	Year	$3.154 \cdot 10^7$ (Δ 8760 h)

7.5. Conversion tables and formula symbols

Temperature – SI unit Kelvin, K

Symbol	Name	in K	in °C
°C	Degrees Celsius	$\vartheta/^\circ\text{C} + 273.16$	1
deg F	Degrees Fahrenheit	$\vartheta/\text{deg F} \cdot 5/9 + 255.38$	$(\vartheta/\text{deg F} - 32) \cdot 5/9$

Angle – SI unit radian, rad = m/m

Symbol	Name	in rad
	Full angle	2π
gon	Gon (new deg.)	$\pi/200$
°	Degree (deg.)	$\pi/180$
'	Minute	$\pi/1.08 \cdot 10^4$
"	Second	$\pi/6.48 \cdot 10^5$

Pressure – SI unit Pascal, Pa = N/m² = kg/ms²

Symbol	Name	in Pa	in bar
Pa = N/m ²	Pascal	1	0.00001
hPa = mbar	Hectopascal = Millibar	100	0.001
kPa	Kilopascal	1000	0.01
bar	Bar	100000	1
MPa = N/mm ²	Megapascal	1000000	10
mm WS	Millimetres, head of water	9.807	0.0001
lbf/in ² = psi	pound-force per square inch	6895	0.0689
lbf/ft ²	pound-force per square foot	47.88	0.00048

Energy (also work, amount of heat) – SI unit Joule, J = Nm = Ws

Symbol	Name	in J
kWs	Kilowatt second	1000
kWh	Kilowatt hours	$3.6 \cdot 10^6$
kcal	Kilocalorie	4186
lbf x ft	pound-force foot	1.356
Btu	British thermal unit	1055

7.5. Conversion tables and formula symbols

Power – SI unit Watt, W = m² kg/s³ = J/s

Symbol	Name	in W
kW	Kilowatt	1000
PS	Continental horsepower	735.5
hp	horsepower	745.7

Volume – SI unit, m³

Symbol	Name	in m ³
l	Litre	0.001
in ³	cubic inch	$1.6387 \cdot 10^{-5}$
ft ³	cubic foot	0.02832
gal	(UK) gallon	0.004546
gal	(US) gallon	0.003785

Dynamic viscosity η – SI unit Pas = kg/ms

Symbol	Name	in mPas
Pas = kg/ms	Pascal second	1000
P	Poise	100
cP	Centipoise	1
lb/ft h	pound(av)/foot hour	0.4134
lb/ft 2	pound(av)/foot second	1488.16

Kinematic viscosity ν – SI unit m²/s

Symbol	Name	in cSt
m ² /s	square metres/second	1000000
St	Stoke	100
cSt	Centistoke	1
ft ² /h	square foot/hour	25.81
ft ² /s	square foot/second	92903

Abrasion protection: Elastic intermediate layer between corrugated hose and braiding. With dynamic loads, the friction between the hose and the braiding is reduced. This results in a longer service life.

Amplitude: Greatest oscillation amplitude around the central axis.

Angular deflection: Rotation of ends of a hose assembly relative to each other.

Annularly corrugated hose: Corrugated with ring-shaped, parallel ridges.

Approval tests: → test certificates

Axial deflection: Adjustment of the ends of the hose assembly relative to each other in the direction of the hose axis. Braided metal hoses are only able to absorb axial movements to a very limited extent.

Anchor point: Support for displacement and torsion-proof absorption of all pipeline forces and moments, e.g. through thermal expansion, internal pressure, rigidity, mass flow. Only light anchor points are required for the use of metal hose assemblies. It is their task to secure the hose assemblies in the mounted position and to prevent the transmission of vibrations or movements. They are attached to the transmitting pipeline immediately at the end of the hose assembly.

Bending radius: Radius of the hose bend in relation to the hose axis. The corresponding values are available in the appropriate data sheet of the metal hose. With corrugated hose assemblies, it is necessary to differentiate between the smallest permissible bending radius, the minimum bending radius for one-off movements and the nominal bending radius for frequent movements. The minimum bending radius must only be used with static loads, e.g. for balancing of assembly inaccuracies. The hose should not be bent with this radius more than 4-5 times. The minimum bending radius of stripwound hoses is the bending radius through which the hose can be bent to a minimum without causing plastic deformation.

Braiding: Single or multiple wire round section braiding on the outside of the metal hose. To prevent the hose stretching through internal pressure, the braiding is connected to the ends of the hose fittings on both sides.

Buckling protection: Mostly a stripwound hose with engaged profile attached to the area of the corrugated hose ends to prevent falling below the minimum bending radius.

Burst pressure: Pressure, where the hose assembly fails due to a visible leak or a broken component. According to DIN ISO 10380, the burst pressure must be at least four times the permissible operating pressure.

Connection fitting: Connector for functional connection of the metal hose with associated lines or devices. The hose fitting is characterised by the hose and connection link. In most cases, HYDRA metal hoses are supplied as pre-finished units (hose assemblies) complete with connection fittings (flanged joints, threaded connections, welding ends etc.). In addition to the connection fittings listed in the tables, the hoses can be fitted with practically any welded, brazed or screw-on connection.

Corrugated hose: Pressure-tight metal hose with corrugated profiling in the wall. The elasticity of the corrugated flanks gives the corrugated hose great elastic pliability. The two basic types are: annularly corrugated hose and helically corrugated hose.

Corrugation crest: Torus-shaped half shell, which limits the corrugation on the outside diameter (outer crest) or on the inside diameter (inner crest).

Corrugation flank: Connection of outer and inner crests. The two corrugation flanks in a corrugation can be positioned in parallel or at a slant.

Corrugation: Smallest functional element of a corrugated hose, corrugated bellows and corrugated pipes whose profile guarantees both compressive strength and tightness.

Cross-section form: Mostly round, but stripwound hoses are also available in quadrilateral and polygonal form.

7.6 Glossary

DN: → nominal diameter

Documentation: → test certificates

Double hose assembly: Two hose assemblies pushed together with larger or smaller differences in cross-sections. One of the lines, usually the inner one, conveys liquid, whilst the outer line conveys a heating medium or a refrigerant. In other cases, the outer pipeline – the coated pipeline – is purely a safety device that is either evacuated and controlled appropriately or is filled with gas or liquid and which acts as a buffering component.

Double pipeline: → double hose assembly

Effective cross-section: The cross-section area, which determines the size of the axial force under internal or external pressure. It is approximately the area of the average corrugation diameter.

Elevation, elevation movement: In the U-bend configuration test, parallel displacement of both ends of a metal hose in 180° bend at the hose level.

Expansion joint: Metal bellows with connection fittings on both sides and, if necessary, with anchors to absorb the pressure reaction forces or targeted restriction of flexibility. They are used to balance axial, angular and/or lateral deformation in piping.

Fully flexible hose length: Length of the hose without end sleeves, without connectors ISO 10380: effective length.

Helically corrugated hose: Corrugated hose with helical, circumferential corrugations.

Inside diameter: Diameter of the largest sphere that can be pushed through the hose.

Insulation: HYDRA metal hoses can be supplied ex works for different purposes with insulation. In most cases, the hoses are fitted as required by the customer with suitable bindings, insulating sheaths or other special insulation materials. Care should be taken to ensure no corrosive materials are used.

7.6 Glossary

Interlocked profile: Stripwound hose profile made from metal strips folded into each other.

Internal load: Usual pressure load that affect the inner surface of the hose.

Lateral movement: Relative offset of the ends of the hose assembly, perpendicular to the hose axis.

Leakage rate: The volume of test medium the flows through a leak as a result of a pressure difference within a set period of time. The SI unit of the leakage rate is N m/s, the standard unit is mbar l/s. A leak with a leakage rate of 10^{-8} mbar l/s occurs if there is a pressure increase of 1 mbar in an evacuated component, with a volume of 1 litre, in 10^8 seconds, that is approx. 3 years. This leak corresponds to a pore size of less than 10^{-4} mm.

Length assessment; Total length/nominal length (NL): Tolerated delivery length of a hose assembly, i.e. total length including length of fittings, typically measured from weld connection to weld connection, sealing surface to sealing surface etc. neutral hose length: additional, flexible hose length to prevent movement in the area of the connections. In this calculation, the neutral hose length is added to the minimum length required to absorb the movement. The calculation formulas in this manual take into account a neutral length, should this be necessary.

Load cycles, load cycles endured: A load cycle (alternation of load) is the single movement of a hose and return to its original position. The load cycles endured is the number of alternations of load achieved up to a certain event (breakdown, end of operation, exchange).

Material certificates: → Test certificates regarding the chemical analysis and mechanical characteristics of the material used.

Metal bellows: Flexible, short line component made of metal, whose large axial and bending flexibility is based on a profiling of its wall. The four basic types are corrugated bellows, diaphragm bellows, lenticular bellows, toroidal bellows.

7.6 Glossary

Metal hose assembly: Flexible pipeline with high, elastic pliability. It consists of a metal hose, with connection fittings on both sides and, in the case of corrugated hoses, often an outer braid.

Metal hose: Flexible component of a metal hose assembly, whose large elastic pliability is based on a profiling of its wall. The two basic types are: stripwound hose and corrugated hose.

Minimum bending radius: → bending radius

Movement: Relative movement of the two ends of the hose assembly to each other. By definition, corrugated hoses should only carry out bending movements, i.e. sideways movements (angular, lateral). The direction of movement here is on the same level as the hose axis. With very small amplitudes, such as those which occur with vibrations, all-round movements can be absorbed by the hose, e.g. with 90° installation for the absorption of vibrations.

Neutral hose length: Additional hose length to reduce movement in the area of the connections. In this calculation, the neutral hose length is added to the minimum length required to absorb the movement. The calculation formulas in this manual take into account a neutral length, should this be necessary.

Nominal bending radius: → bending radius

Nominal diameter (DN): Characteristic value for piping. Its numerical value approximately corresponds to the inside diameter in mm.

Nominal length (NL): → total length

Nominal pressure (PN): The nominal pressure is a key figure, usually abbreviated to PN and referring to the pressure; it is dimensionless.

The numerical value of the nominal pressure indicates the operating pressure in bar at 20°C. The "permissible static operating pressure at 20°C SF4" as indicated for all hose types is also to be understood as a nominal pressure, though dimensioned. The PN according to ISO 10380 is a particular nominal pressure: the hose assemblies were type-tested at PN. The following, amongst others, were hereby

7.6 Glossary

tested: burst pressure, elongation under pressure, number of load cycles in U-bend.

Operating pressure: → permissible operating pressure (PS)

Operating temperature: → permissible operating temperature (TS)

Outside diameter: Describes the outer diameter of metal hoses measured from the vertex of the hose profile (D) or of the hose braiding (D1).

Parallel corrugation: Corrugation structure with evenly spaced parallel ridges and with a main level perpendicular to the hose axis.

Permissible operating pressure (PS): According to the definition of the pressure device guidelines, this is the maximum permissible continuous operating pressure (or design pressure) for the pressure tank (here hose) in bar at the min./max. permissible operating temperature TS.

Permissible operating temperature (TS): According to the definition of the pressure device guidelines, the min./max. permissible continuous operating temperature (or design temperature) in °C for the pressure tank at the maximum permissible operating pressure PS.

Pitch: Distance between neighbouring corrugations, e.g. distance from outer apex to outer apex in axial direction of the hose.

PN: → nominal pressure

Pressure hose: → pressure-tight hose → corrugated hose

Pressure: → burst pressure, permissible operating pressure

Production length: The production lengths given in the tables are the production lengths on hoses sold by the metre without assembly.

Profile height: Distance between inner and outer apex in radial direction to the hose.

PS: → permissible operating pressure

Quick release coupling: Connection fitting made of two coupling halves (male, female parts) for a metal hose assembly. The coupling process involves pressing the two halves together and linking them by turning cam levers.

Reduction factor for the compressive strength with increased operating temperatures (C_r): this takes into account the drop in stability of materials with operating temperatures over 20 °C and is also defined by the relationship of the 1% yield point of the component with a working or calculated temperature-to the 1% yield point at 20 °C. The lowest value of all the individual components applies in the case of components made up of several materials.

Rotation: → torsion

Round wire coil: Additional, external protection against abrasion with rough operating conditions.

Sealing: With the removable connection fittings for corrugated hoses, it is possible to differentiate between metal-sealing and flush-sealing connections and those which seal in the thread. Please select the type of connection or sealing materials suited to your application, in particular with regard to stability (medium/temperature) and reuse.

Service life: Is dependent on the operating conditions and the movement strain. With dynamic loads, it is generally the case that the service life indicates the number of load cycles performed before the first leak.

Stripwound hose: Metal hose made of profiled and helically-wound metal strips. The two basic types are: stripwound hose with engaged profile and stripwound hose with seam/interlocked profile.

Stripwound hose with engaged profile: Stripwound hose, whose profile coils loosely overlap or intermesh with hooks on the strip edge. With increased tightness requirements, a sealing thread can be woven into the profile.

Stripwound hose with interlocked profile: Stripwound hose, whose profile coils loosely intermesh with seams on the strip edges. These profiles are mostly produced metallurgically sealed without additional sealing threads.

Temperature factors: → reduction factor

Test certificates: Documentation of tests and certification of component characteristics.

Test pressure: Excess pressure to which the hose assembly is exposed before set up. HYDRA corrugated hoses are checked for leak tightness and compressive strength before delivery. The test pressure for Witzenmann metal hose assemblies may not exceed 1.5 x nominal pressure. If not specified otherwise hoses are tested with 10 bar.

Torsion: Rotation of metal hose around its longitudinal axis. Torsion leads to a significant reduction in the service life of metal hose assemblies. Attention must be paid during mounting to ensure that the hose assemblies are mounted in a torsion-free manner and are not twisted by future movement strains.

Total length / nominal length (NL): Tolerated supply length of hose assembly, i.e. cut trim length plus fittings length.
Corrugated length / pure hose length: cut trim length of the metal hose (ZRL)

TS: → permissible operating temperature

Variations in pressure / pulsations: Can also significantly reduce the service life of a metal hose through fatigue processes.

7.7. Inquiry specification

If the customer does not provide any details of the medium and operating conditions, we assume the hose assembly comes under the category of so-called "sound engineering practice", in the sense of the pressure equipment directive.

Specification for HYDRA metal hose assemblies			
Position			
Quantity			
Hose/braiding type designation			
Material	Metal hose		
	Braiding		
Nominal diameter DN			
Nominal length			
Type designation of connection fittings or connection dimensions			
Medium			
Pressure (bar)	Operating pressure		
	inside <input type="checkbox"/> constant <input type="checkbox"/> Design pressure (poss.)		
	outside <input type="checkbox"/> intermittent <input type="checkbox"/> Test pressure		
Operating temperature in °C			
Movement	Type and size		
	Load cycles endured		
Installation form	90° / 180° / straight		
External influences	Mech. / chem. load		
	Miscellaneous		
Vibrations	Ampl. (mm) / frequency (Hz)		
	Direction		
Acceptance test procedure / certification Hose / braiding / fittings / pressure test			
Miscellaneous			

7.7. Inquiry specification

